



ROHDE & SCHWARZ

Test and Measurement
Division

Operating Manual

**TEST RECEIVER FOR
DIGITAL MOBILE RADIO
NETWORKS**

ESVD

1026.5506.10

Printed in the Federal
Republic of Germany

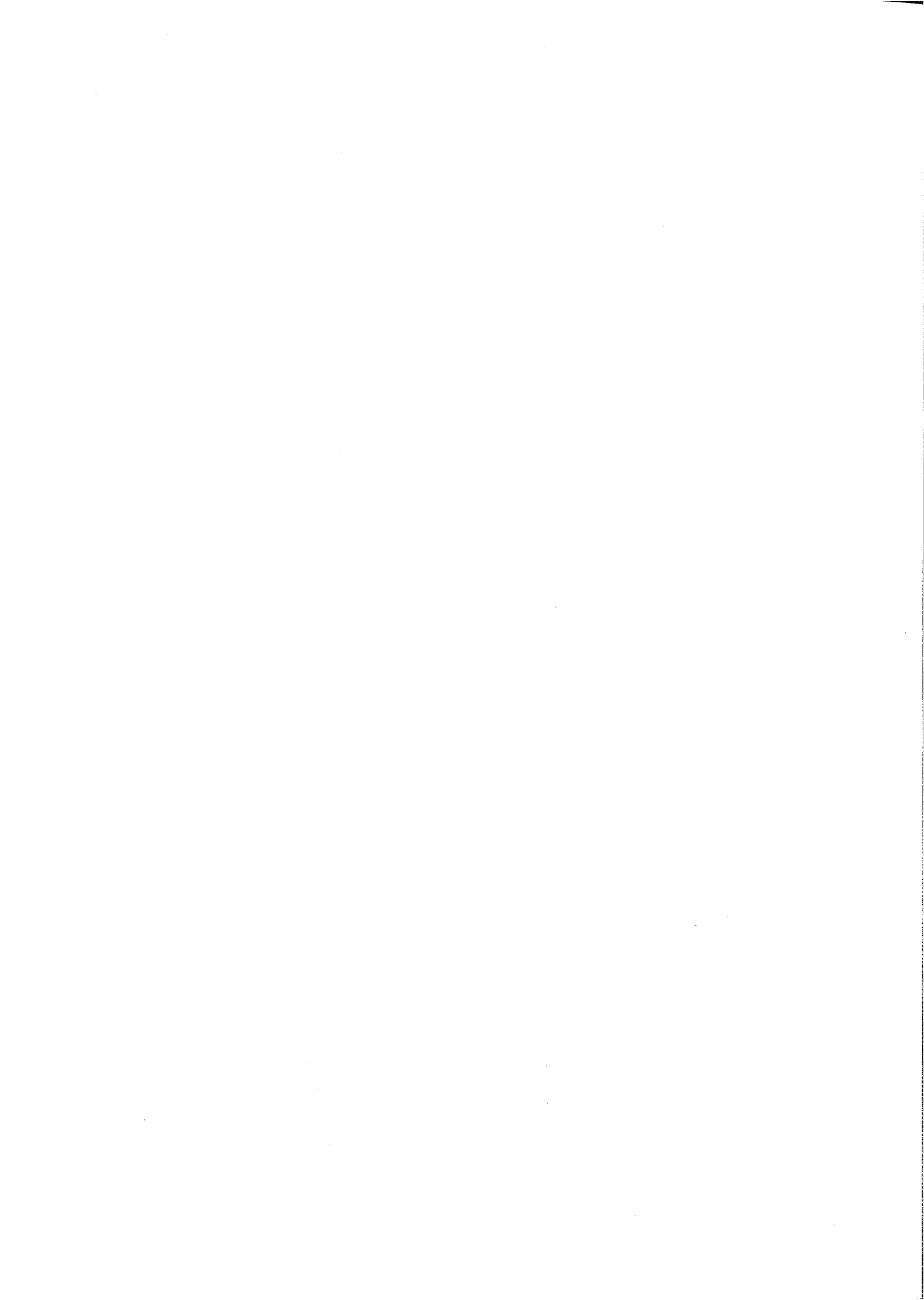

Certified Quality System ISO 9001

DQS REG. NO 1954-04

Qualitätszertifikat

Sehr geehrter Kunde,

Sie haben sich für den Kauf eines Rohde & Schwarz-Produktes entschieden. Hiermit erhalten Sie ein nach modernsten Fertigungsmethoden hergestelltes Produkt. Es wurde nach den Regeln unseres Qualitätsmanagementsystems entwickelt, gefertigt und geprüft. Das Rohde & Schwarz-Qualitätsmanagementsystem ist nach ISO 9001 zertifiziert.

Certificate of quality

Dear Customer,

You have decided to buy a Rohde & Schwarz product. You are thus assured of receiving a product that is manufactured using the most modern methods available. This product was developed, manufactured and tested in compliance with our quality management system standards.

The Rohde & Schwarz quality management system is certified according to ISO 9001.

Certificat de qualité

Cher client,

Vous avez choisi d'acheter un produit Rohde & Schwarz. Vous disposez donc d'un produit fabriqué d'après les méthodes les plus avancées. Le développement, la fabrication et les tests respectent nos normes de gestion qualité.

Le système de gestion qualité de Rohde & Schwarz a été homologué conformément à la norme ISO 9001.



ROHDE & SCHWARZ



Adressen/Addresses

FIRMENSITZ/HEADQUARTERS

ROHDE & SCHWARZ GmbH & Co. KG

Mühlhofsstraße 15 · D-81671 München
Postfach 801469 · D-81614 München
Internet: <http://www.rsd.de>
M

Telefon/Phone
Telefax
E-mail

+49 89 41 29-0
+49 89 41 29-21 64
-

WERKE/PLANTS

ROHDE & SCHWARZ Meßgerätebau GmbH

Riedbachstraße 58 · D-87700 Memmingen
Postfach 16 52 · D-87686 Memmingen

+49 83 31 1 08-0
+49 83 31 1 08-1 24
-

ROHDE & SCHWARZ GmbH & Co. KG

Werk Teisnach

Kaikenrieder Straße 27 · D-94244 Teisnach
Postfach 11 49 · D-94240 Teisnach

+49 99 23 8 50-0
+49 99 23 8 50-1 74
-

ROHDE & SCHWARZ GmbH & Co. KG · Werk Köln

Graf-Zeppelin-Straße 18 · D-51147 Köln
Postfach 98 02 60 · D-51130 Köln

+49 22 03 49-0
+49 22 03 49-3 08
-

TOCHTERUNTERNEHMEN/SUBSIDIARIES

ROHDE & SCHWARZ Vertriebs-GmbH

Mühlhofsstraße 15 · D-81671 München
Postfach 80 14 69 · D-81614 München

+49 89 4129-20 07
+49 89 4129-35 67
-

ROHDE & SCHWARZ International GmbH

Mühlhofsstraße 15 · D-81671 München
Postfach 80 14 60 · D-81614 München

+49 89 4129-20 05
+49 89 4129-35 97
-

ROHDE & SCHWARZ Engineering and Sales GmbH

Mühlhofsstraße 15 · D-81671 München
Postfach 80 14 29 · D-81614 München

+49 89 4129-37 11
+49 89 4129-37 23
-

R&S BICK Mobilfunk GmbH

Im Landerfeld 7 · D-31848 Bad Münder
Postfach 20 62 · D-31844 Bad Münder

+49 50 42 9 98-0
+49 50 42 9 98-105
-

ROHDE & SCHWARZ FTK GmbH

Wendenschloßstraße 168, Haus 28
D-12557 Berlin

+49 30 6 58 91-0
+49 30 65 55 02 21
-

SIT Gesellschaft für Systeme der Informationstechnik mbH

Wendenschloßstraße 168, Haus 28
D-12557 Berlin

+49 30 6 58 84-2 22
+49 30 6 58 84-1 83
-

ADRESSEN DEUTSCHLAND/ADDRESSES GERMANY

Rohde & Schwarz Vertriebs-GmbH

Mühlhofsstraße 15 · D-81671 München
Postfach 801469 · D-81614 München

+49 89 4129-2007
+4989 4129-3567
-

Zweigniederlassungen der Rohde & Schwarz Vertriebs-GmbH/Branch offices of Rohde & Schwarz Vertriebs-GmbH

Zweigniederlassung Berlin

Ernst-Reuter-Platz 10 · D-10587 Berlin
Postfach 100620 · D-10566 Berlin

(030) 34 79 48-0
(030) 34 79 48-48
-

Zweigniederlassung Büro Bonn

Josef-Wirmer-Straße 1-3 · D-53123 Bonn
Postfach 140264 · D-53057 Bonn

(02 28) 918 90-0
(02 28) 25 50 87
-

Zweigniederlassung Hamburg

Steilshooper Allee 47 · D-22309 Hamburg
Postfach 602240 · D-22232 Hamburg

(040) 63 29 00-0
(040) 630 78 70
-

Zweigniederlassung Köln

Graf-Zeppelin-Straße 18 · D-51147 Köln
Postfach 900149 · D-51111 Köln

(0 22 03) 807-0
(0 22 03) 807-50
-

Zweigniederlassung München

Mühlhofsstraße 15 · D-81671 München
Postfach 801449 · D-81614 München

(089) 41 86 95-0
(089) 40 47 64
-

Zweigniederlassung Nürnberg

Donaustraße 36
D-90451 Nürnberg

(09 11) 64203-0
(09 11) 64203-33
-

Zweigniederlassung Telekommunikation + Mitte

Siemensstraße 20
D-63263 Neu-Isenburg

(0 61 02) 20 07-0
(0 61 02) 20 07-12
-

ADRESSEN WELTWEIT/ADDRESSES WORLDWIDE

Algeria

ROHDE & SCHWARZ Bureau d'Alger
5 B, Place de Laperrine
16035 Hydra-Alger

+2 13 2 592453
+2 13 2 594786
-

Argentina

Precisión Electrónica SRL
Esmeralda 582, Piso 4, Off. 11
1007 Capital Federal
Buenos Aires

+54 1 3 94 48 15
+54 1 3 27 23 32
-

Australia

ROHDE & SCHWARZ
(AUSTRALIA) Pty. Ltd.
63 Parramatta Road
Silverwater, N.S.W. 2141

+61 2 97 48 01 55
+61 2 97 48 1836
rsaussyd@ozemail.com.au

Austria

ROHDE & SCHWARZ-ÖSTERREICH
Ges. m. b. H.
Sonnleithnergasse 20
A-1100 Wien

+43 1 6 02 61 41-0
+43 1 6 02 61 41-14
office@rsoe.com

Azerbaijan

ROHDE & SCHWARZ GmbH & Co. KG
Representative Office Baku
Azerbaijan avenue 35
370139 Baku

+99 4 12 93 31 38
+99 4 12 93 03 14
-

Baltic

Countries siehe/see Denmark

Bangladesh

Business International Ltd.
Corporation Office
House No: 95/A, Block 'F'
Road No: 4, Banani
Dhaka - 1213

+880 2 87 06 53
+880 2 88 82 91
-

Belgium

ROHDE & SCHWARZ BELGIUM N.V.
Excelsiorlaan 31 Bus 1
B-1930 Zaventem
Alfons_Verpoorten%RSB@notesgw.Compuserve.Com

+32 2 7 21 50 02
+32 2 7 25 09 36
-

Brazil

ROHDE & SCHWARZ
Precisão Eletrônica Ltda.
Rua Geraldo Flausino Gomes, 42.º and
04575-060 São Paulo-SP

+55 11 5505 21 77
+55 11 5505 57 93
rsbras@ibm.net

Brunei

GKL Equipment PTE. Ltd.
#11-01 BP Tower
396, Alexandra Road
Singapore 119954
Republic of Singapore

+65 2 76 06 26
+65 2 76 06 29
gkleqpt@signet.com.sg

Adressen/Addresses

Bulgaria	ROHDE & SCHWARZ Representation Office Bulgaria 39, Fridtjof Nansen Blvd. 1000 Sofia	+359 2 9 63 43 34 +359 2 9 63 21 97 -	Büros/Offices: Aix-en-Provence Lyon Nancy	+33 4 94 07 39 94 +33 4 94 07 55 11 +33 4 78 29 88 10 +33 4 78 29 94 71 +33 3 83 54 51 29 +33 3 83 55 39 51
Canada	Kommunikationstechnik/Communications Equipment: ROHDE & SCHWARZ CANADA Inc. 555 March Rd. Kanata, Ontario K2K 2M5 Messtechnik/T & M Equipment: TEKTRONIX CANADA, Inc. 785 Arrow Road Weston, Ontario, M9M 2L4	+1 6 13 5 92 80 00 +1 6 13 5 92 80 09 - +1 4 16 7 97 50 00 +1 4 16 7 47 75 81 -	Greece MERCURY SA. 6, Loukianou Str. GR-10675 Athens	+30 1 7 22 92 13 +30 1 7 21 51 98 mercury@hol.gr
Chile	DYMEQ Ltda. Avenida Larrain 6666 Santiago	+56 2 277 50 50 +56 2 227 87 75 -	Guatemala	siehe/see Mexico
China	ROHDE & SCHWARZ Representative Office Beijing Beijing Towercrest Plaza, Rm 821 No. 3 Mai Zi Dian West Road Chao Yang District Beijing 100016/People's Republic of China	+86 10 64 67 23 65 +86 10 64 67 23 15 rsbp@public3.bta.net.cn -	Honduras	siehe/see Mexico
Colombia	Ferrostaal de Colombia Ltda. Av. Eldorado No. 97-03 Interior 2 Santa Fé de Bogotá, D.C.	+57 1 2 67 63 21 +57 1 4 13 18 06 -	Hong Kong	Schmidt & Co. (HK) Ltd. 9/F North Somerset House Taikoo Place 979 King's Road Quarry Bay, Hong Kong
Costa Rica	siehe/see Mexico		Hungary	ROHDE & SCHWARZ Budapesti Iroda Etele ut. 68 H-1115 Budapest
Republic of Cyprus	HINIS TELECAST LTD. Agiou Thoma 18 Kiti Larnaca 7550	+357 4 42 51 78 +357 4 42 46 21 -	Iceland	siehe/see Denmark
Czech Republic	ROHDE & SCHWARZ - Praha, s.r.o. Pod kastany 3 CZ-160 00 Praha 6	+420 2 24 32 20 14 +420 2 24 31 70 43 rscz@rohde.mail.602.cz	India	ROHDE & SCHWARZ India Pvt. Ltd. A-382 Defence Colony New Delhi 110024
Denmark	ROHDE & SCHWARZ DANMARK A/S Ejby Industrivej 40 DK-2600 Glostrup	+45 43 43 66 99 +45 43 43 77 44 RSDK@post1.tele.dk	Indonesia	P.T. REKANUSA SOLUSI Menara Rajawali, 24th floor Jl Mega Kuningan Lot # 5.1 Kawasan Mega Kuningan Jakarta 12950
Ecuador	DIGITEC Cia. Ltda. Casilla 17-03-408A El Heraldo 121 y El Dia Quito	+593 2 43 03 73 +593 2 44 37 82 digitec1@digitec.com.ec	Iran	ROHDE & SCHWARZ IRAN Liaison Office - Reg. N° RFC 1947 Dr. Beheschty Ave., Pakistan Ave., 12th Street N° 1 Tehran 15317
El Salvador	siehe/see Mexico		Ireland	siehe/see Great Britain
Finland	Orbis Oy P.O. B. 15 FIN-00421 Helsinki	+358 9 47 88 30 +358 9 53 16 04 info@orbis.fi	Italy	ROHDE & SCHWARZ ITALIA S.p.a. Via Tiburtina 1182 I-00156 Roma Centro Direzionale Lombardo Via Roma 108 I-20060 Cassina de' Pecchi (MI)
France	ROHDE & SCHWARZ FRANCE Immeuble "Le Newton" 25-27, rue Jeanne Braconnier F-92366 Meudon-la-Forêt Cédex Niederlassung/Subsidiary Rennes: ROHDE & SCHWARZ FRANCE Sigma 1 Rue du Bignon F-35135 Chantepie Niederlassung/Subsidiary Toulouse: ROHDE & SCHWARZ FRANCE Technoparc 3 B.P.501 F-31674 Labège Cédex	+33 1 41 36 10 00 +33 1 41 36 11 10 - +33 2 99 51 97 00 +33 2 99 41 91 31 - +33 5 61 39 10 69 +33 5 61 39 99 10 -	Japan	ADVANTEST Corporation RS Sales Department 1-32-1 Asahi-cho Nerima-ku Tokyo 179 +81 3 39 30 40 30 +81 3 39 30 41 86 yoshimu@inst.advantest.co.jp
			Kazakhstan	ROHDE & SCHWARZ GmbH & Co. Representative Office Almaty Pl. Respubliki 15 480091 Almaty
			Korea	Hana Technica Corp. Seoul Kangnam, P.O. Box 1458 Young Dong Bldg. 4F 63-16 Nonhyun-Dong, Kang Nam-Ku

Adressen/Addresses

	Seoul				
Kuwait	Zaid Al-Kazemi Sons Trading Co. P.O. Box 30, Safat 13001 Zaid Al-Kazemi Building Mubarak Al-Kabeer Street Kuwait City	+965 243 72 00 +965 240 15 62 adnan@ncc.moc.kw			
Lebanon	CONNECTIONS S.A.R.L. Sami Solh Street Cemate Building 201 - 2nd Fl. Sami El-Salh Street - Badaro Beirut	+961 1 42 48 25/6/7 +961 1 42 55 57 TREZKALL@INCO.COM.LB			
Liechtenstein	siehe/see Switzerland				
Luxembourg	siehe/see Belgium				
Malaysia	DAGANG TEKNIK SDN. BHD. No. 9, Jalan SS 4D/2 Taman People's Park 47301 Petaling Jaya Selangor Darul Ehsan	+60 3 7035503/7035568 +60 3 7 03 34 39 danik@tm.net.my			
Malta	ITEC - International Technology Ltd. B'Kara Road San Gwann	+35 6 37 43 00 +35 6 37 43 53 itec@keyworld.net			
Mexico	Vertrieb Kommunikationstechnik/ Sales Communications Equipment: ELECTROINGENIERIA de Precisión S.A. EPSA S.A. Uxmal 520, Colonia Vertiz Narvarte 03600 Mexico DF	+52 5 5 59 76 77 +52 5 5 75 33 81 epsa@compuserve.com			
	Vertrieb Meßtechnik/Sales T & M Equipment: Tektronix, S.A. de C.V. Periférico Sur 5000, 8° Piso Col. Insurgentes Cuicuilco Coyoacán 04530 - Mexico, D.F.	+525 666 63 33 +525 666 63 36			
Nepal	Abishek Trade Links (P) Ltd. P.O.B. 9700 Kathmandu	+97 71 25 69 30 +97 71 24 25 73 Durbar@hotel.mos.com.np			
Netherlands	ROHDE & SCHWARZ NEDERLAND B.V. Perkinsbaan 1 3439 ND Nieuwegein	+31 30 6 00 17 00 +31 30 6 00 17 99 Rob.DenHartog/RSN%RSN@RSD.de			
New Zealand	Nichecom Level 1 Tawa Plaza 210 Main Rd / P.O.B. 56-045 Tawa, Wellington	+64 4 2 32 32 33 +64 4 2 32 32 30 ISDN +64 4 2 37 30 10 robin.hodgson@nichecom.co.nz			
Nicaragua	siehe/see Mexico				
Norway	ROHDE & SCHWARZ NORGE Østensjøveien 36, P.O.B. 103 BRYN N-0611 Oslo	+47 23 17 22 50 +47 23 17 22 69 -			
Pakistan	TelcoNet Communications & Engineering 213/D, Ordnance Road Rawalpindi-Pakistan-46000	+92 51 25 69 53 +92 51 51 86 27 telecom@tnc.isb.erum.com.pk			
Panama	siehe/see Mexico				
Papua- New Guinea	siehe/see Australia				
Philippines	MARCOM Industrial Equipment, Inc. MCC P.O.Box 2307 6-L Mezzanine Suite, Vernida I Condominium 120 Amorsolo St. Legaspi Village Makati City/Philippines 3117	+632 8 13 29 31 +632 8 17 05 07			
Poland	ROHDE & SCHWARZ Oddzial w Polsce ul. Stawki 2, Pietro 28 00-193 Warszawa	+48 22 8 60 64 90 bis 98 +48 22 8 60 64 99 rspoland@rscoe			
Portugal	TELERUS Sistemas de Telecomunicações, S.A. Rua General Ferreira Martins, Lote 6,2.ºB P-1495 Algés	+351 1 4 12 35 90 +351 1 4 12 36 00 telerus@mail.telepac.pt			
Romania	ROHDE & SCHWARZ Representation Office Bucharest Uranus 98 Bloc U8, Scara 2, Etaj 5, Ap. 36 RO-76102 Bucuresti	+40 1 4 10 68 46 +40 1 4 11 20 13 sandu@rohde.eunet.ro			
Russian Federation	ROHDE & SCHWARZ Representative Office Moscow 1-j Kazacij per., 7 109017 Moscow	+7 095 2 34 49 62 +7 095 2 34 49 63 evg@rohde-schwarz.msk.ru			
Saudi Arabia	Haji Abdullah Alireza & Co. Ltd. P.O.B. 361 Riyadh 11411 Kingdom of Saudi Arabia	+966 1 4 65 44 78 +966 1 4 65 07 82 -			
Singapore	Vertrieb/Sales: INFOTEL TECHNOLOGIES LTD. 19 Tai Seng Drive Kinergy Building # 06-00 Singapore 535222	+65 2 87 68 22 +65 2 84 95 55 general@infotel.com.sg			
	Support Centre Asia: Rohde & Schwarz Support Centre Asia Pvt. Ltd. 6th Floor, Singapore Technologies Building 19 Tai Seng Drive 535 222 Singapore	+65 4 88 30 10 +65 2 87 30 61 RSSCA@mbox4.singnet.com.g			
Slovak Republic	3S Specialne systémy a software, a.s. Ilkovicova 3 SK-81219 Bratislava	+421 7 72 24 88 +421 7 72 07 68 3s@internet.sk			
Slovenia	ROHDE & SCHWARZ Repräsentanz Ljubljana Koprska 92 SI-61000 Ljubljana	+3 86 61 1 23 46 51 +3 86 61 1 23 46 11 -			
South Africa	S.A. Electro-Medical (Pty) Ltd. 115 Siersteen Road Silvertondale P.O.B. 1784 Pretoria 0001	+27 12 8 04-16 20 +27 12 8 04-20 09 mail@saem.co.za			
Spain	REMA Leo Haag S.A. Salcedo, 11 E-28034 Madrid	+34 91 3 34 10 70 +34 91 7 29 05 06 rema@rema.es			
Sri Lanka	LANKA AVIONICS 658/1/1, Negombo Road Mattumagala Ragama	+94 1 95 66 78 +94 1 95 83 11 -			

Adressen/Addresses

Sweden	ROHDE & SCHWARZ SVERIGE AB Flygfällsgatan 15 S-12830 Skarpnäck	+46 8 6 05 19 00 +46 8 6 05 19 80 info@rss.se	TEKTRONIX Inc. P.O.B. 500, M/S 50-216 Beaverton, OR 97076	+1 800 835 9433 Ext. 6630 +1 800 835 7732 -	
Switzerland	Roschi Télécommunication AG Papiermühlestrasse 145, Postfach CH-3063 Ittigen	+41 31 9 22 15 22 +41 31 9 21 81 01 -	Vietnam	Schmidt Vietnam Co., Ltd. 8/F, Schmidt Tower, Hanoi Intern. Technology Centre SVNHN@SCHMIDTGROUP.COM Cau Gray, Tu Liem, IPO Box 89 Hanoi	+84 4 8 34 61 86 +84 4 8 34 61 88 -
Syria	Electro Scientific Office Baghdad Street Dawara Clinical Lab. Building P.O.B. 8162 Damascus	+963 11 2 31 59 74 +963 11 2 31 88 75 -	Yugoslavia	see/siehe Austria	
Taiwan	FUNCTION ENTERPRISE CO., LTD. 16F, No. 30, Pei-Ping East Road Taipei, Taiwan R.O.C.	+8 86 2 23 21 70 70 +8 86 2 23 95 87 82 hibiscus@function.linkease.com.tw			
Thailand	Vertrieb Kommunikationstechnik/Sales Communications Equipment: TPP Operations Co. Ltd. 70 MOO, 3 Mooban Mantana, Soi Chimplee 4, Boromrajchonnee Rd., Talingchan, Bangkok 10170	+662 4 48 51 59 +662 8 84 17 98	Nicht aufgeführte Länder/Countries not listed:	ROHDE & SCHWARZ GmbH & Co. KG Division 5Z Postfach 80 14 69 D-81614 München	- +49 89 41 29-36 62 -
	Vertrieb Meßtechnik/Sales T & M Equipment: Schmidt Scientific (Thailand) Ltd. Government Housing Bank Bldg. Tower II, 19th Floor, 212 Rama 9 Rd., Huaykwang, Bangkok 10320	+662 6 43 1330-9 +662 6 43 1340-1			
Turkey	ROHDE & SCHWARZ LIAISON OFFICE ISTANBUL Bagdad Cad. 191/3, Ard. TR-81030 Selamicesme-Istanbul	+90 2 16 3 85 19 17 +90 2 16 3 85 19 18 RSTURK@unimedya.net.tr			
Ukraine	ROHDE & SCHWARZ GmbH & CoKG Representative Office Kiev ul. Patrisa Lumumba, 4 UKR-252042 Kiev	+3 80 44 2 68 60 55 +3 80 44 2 68 83 64 rsbkiev@public.ua.net			
United Arab Emirates	Service-Center für den Mittleren Osten/ Service Center for the Middle East: ROHDE & SCHWARZ Emirates L.L.C. P.O.B. 31156 Abu Dhabi	+9 71 2 31 20 40 +9 71 2 31 30 40 -			
	Vertrieb/Sales: ROHDE & SCHWARZ P.O.B. 53726 Dubai	+9 71 4 48 28 29 +9 71 4 48 27 94 -			
	R&S BICK Mobile Communication P.O.B. 17466 JAFZ, LOB 04-028 Dubai	+9 71 4 81 36 75 +9 71 4 81 36 76 -			
United Kingdom	ROHDE & SCHWARZ UK Ltd. Ancells Business Park Fleet, Hampshire GU 13 8UZ	+44 12 52 81 13 77 +44 12 52 81 14 47 -			
USA	Vertrieb Kommunikationstechnik/ Sales Communications Equipment: ROHDE & SCHWARZ, Inc. 4425 Nicole Drive Lanham, MD 20706	+1 301 4 59 88 00 +1 301 4 59 28 10 -			
	Vertrieb Meßtechnik/Sales T & M Equipment:				



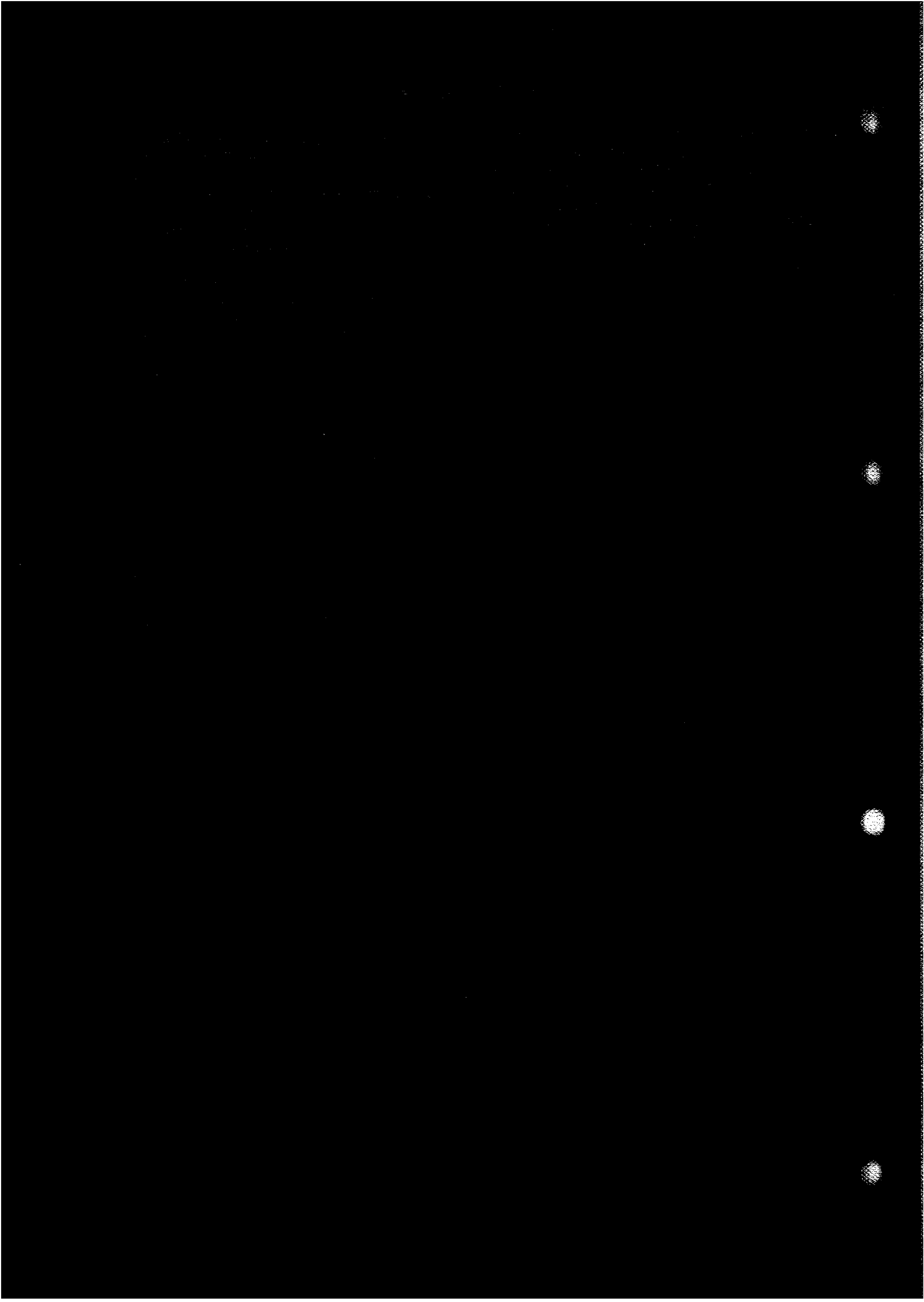



ROHDE & SCHWARZ

Instruments
Division

User Report

Product:

Serial No.:

Firmware/software version:

Your Name:

Date:

Your Firm:

Phone:

Address:

Fax:

Contents of Report

New Application
(Solution Request)

Suggestion for Improve-
ment in Instrument Usage

Measurement Error or
Hardware Malfunction

Firmware or
Software Error

Correction of Operating
or Service Manual

In case of error: Is the error reproducible?

yes

no

Severity Level:

serious

normal

low

Problem Description:

(Give as detailed information as required for duplicating the problem)

Encl(s): Draft of System Configuration, Measurement Results, Hard Copies
Remedy(ies), Interim Solution, Workaround

The user report is to be completed by the R&S Sales & Support Engineer

R&S Sales & Support Office:

R&S Sales & Support Engineer:

Send a copy to R&S Munich, Product Marketing, for R&S use only

Date of reply to user:



Contents

Page

1	Data Sheet	
2	Preparations for Use	
2.1	Putting into Operation	2.1
2.1.1	Setting up the Receiver	2.1
2.1.2	Rackmounting	2.1
2.1.3	Power Supply	2.1
2.1.3.1	Mains Operation	2.1
2.1.3.2	Operation with Internal Battery	2.2
2.1.3.3	Operation with External Battery	2.4
2.1.4	Switching on	2.4
2.2	Function Test	2.5

	Page
3	Operating Instructions 3.1
3.1	Explanation of Front and Rear Panel View 3.1
3.1.1	Front View 3.1
3.1.2	Rear View 3.15
3.2	Manual Operation 3.20
3.2.1	Connecting the Voltage to be Measured 3.20
3.2.1.1	Sinusoidal Signals and D.C. Voltage 3.20
3.2.1.2	Pulse Signals 3.21
3.2.2	Input of Numeric Values 3.21
3.2.3	Operation of the Receiver Functions 3.22
3.2.3.1	Setting the Receiver Frequency 3.22
3.2.3.1.1	Numeric Input of the Frequency 3.22
3.2.3.1.2	Frequency Setting using the Rotary Knob 3.22
3.2.3.1.3	Frequency Tuning using the ↓ and ↑ keys 3.23
3.2.3.1.4	Input of Tuning Step Size 3.23
3.2.3.2	Selecting RF Attenuation (ATTENUATION) 3.24
3.2.3.3	Selecting the Operating Mode (MODE) 3.25
3.2.3.4	Operation with Preamplifier (PREAMP) 3.25
3.2.3.5	Automatic Setting of Attenuation (Autorange Operation) 3.26
3.2.3.6	Selecting the Operating Range (OPERATING RANGE) 3.27
3.2.3.7	Level Indication 3.28
3.2.3.7.1	Digital Level Indication 3.28
3.2.3.7.2	Analog Level Indication 3.29
3.2.3.7.3	Overload of the Receiver 3.29
3.2.3.8	Selecting the IF Bandwidth (IF BW) 3.30
3.2.3.9	Selecting the Indicating Mode (DETECTOR) 3.31
3.2.3.9.1	Average Value Measurement (AV) 3.31
3.2.3.9.2	Peak Value (Pk) 3.31
3.2.3.9.3	Measurement of Broadband Interferences (Pk/MHz) 3.32
3.2.3.9.4	Quasipeak (QP) 3.32
3.2.3.9.5	Pulse Weighting in Various Indicating Modes 3.33
3.2.3.10	Selecting the Measuring Time (MEAS TIME) 3.34
3.2.3.11	Selecting AF Demodulation (DEMODO) 3.36
3.2.3.12	Calibration and Measurement Accuracy 3.37
3.2.3.12.1	Short Calibration 3.37
3.2.3.12.2	Total Calibration 3.37
3.2.3.12.3	Error Messages during Calibration 3.38
3.2.3.12.4	Measurement Accuracy 3.39

	Page
3.2.3.13	Special Functions (SPEC FUNC) 3.41
3.2.4.	Operation of the Menu Functions 3.47
3.2.4.1	Input and Editing in the DATA INPUT Display 3.47
3.2.4.1.1	Editing the Menus 3.47
3.2.4.1.2	Input of Texts and Labellings 3.48
3.2.4.2	Configuration of the Receiver (Keypad INSTR STATE) 3.48
3.2.4.2.1	Selecting the Instrument Presettings (SETUP Menu) 3.48
3.2.4.2.2	Entering and Calling of Transducer Factors (TRANSDUCER Menu) 3.50
3.2.4.2.3	Calling the Self Test (SELF TEST Menu) 3.58
3.2.4.3	Execution of Frequency Scans (Keypad ANALYSIS) 3.59
3.2.4.3.1	Generation and Editing of Data for a Frequency Scan 3.59
3.2.4.3.2	Input of Limit Lines 3.63
3.2.4.3.3	Extended Functions of RF Analysis (OPTIONS) 3.66
3.2.4.3.4	Frequency Scan 3.72
3.2.4.4	Generating a Test Report (Keypad Report) 3.74
3.2.4.4.1	Selecting the Pre-setting of the Printer and Plotter 3.75
3.2.4.4.2	Input of the Labellings for Printer or Plotter Output 3.77
3.2.4.4.3	Output of the Measurement Results on Printer 3.78
3.2.4.4.4	Output of the Measurement Results on Plotter 3.78
3.2.4.5	Saving and Calling the Receiver Configuration 3.80
3.2.5	Connecting External Devices 3.81
3.2.5.1	Connecting the Transducers (ANTENNA CODE) 3.81
3.2.5.2	AF Output 3.82
3.2.6	Inputs and Outputs at the Rear Panel 3.82
3.2.6.1	IF Output 74.7 MHz (74.7 MHz OUTPUT) 3.82
3.2.6.2	IF Output 10.7 MHz (10.7 MHz OUTPUT) 3.82
3.2.6.3	Video Output (VIDEO OUTPUT) 3.83
3.2.6.4	Reference Output (10 MHz REF OUTPUT) 3.83
3.2.6.5	I/Q Outputs (I OUTPUT and Q OUTPUT) 3.83
3.2.6.5	USER INTERFACE 3.84
3.2.6.5.1	Serial Interface (RS-232 C) 3.85
3.2.6.5.2	Serial Bus 3.85
3.2.6.5.3	TTL-I/O Lines 3.86
3.2.6.5.4	Trigger Input 3.86
3.2.6.5.5	Analog Voltages 3.86
3.2.6.5.6	Supply Voltages 3.86
3.2.6.6	Printer Interface 3.87
3.2.6.7	IEC Bus 3.88
3.2.6.8	Connecting a Keyboard 3.89

	Page
3.3 Remote Control (IEC-Bus)	3.90
3.3.1 Setting the Device Address	3.91
3.3.2 LOCAL - REMOTE Switchover	3.91
3.3.3 Interface Messages	3.92
3.3.3.3 Universal Commands	3.92
3.3.3.2 Addressed Commands	3.92
3.3.4 Device Messages	3.94
3.3.4.1 Commands Received by the Test Receiver in Listener Mode (Controller to Device Messages)	3.94
3.3.4.2 Messages Sent by the Test Receiver in Talker Mode (Device to Controller Messages)	3.97
3.3.4.3 Common Commands	3.99
3.3.4.4 Device-specific Commands	3.105
3.3.5 Service Request and Status Register	3.114
3.3.6 Resetting of Device Functions	3.122
3.3.7 Command Processing Sequence and Synchronization	3.122
3.3.8 Output of Measured Results via IEC Bus	3.123
3.3.9 Transfer of the IEC Bus Controller Function	3.128
3.3.10 Operating Modes for Fast Level Measurement and Triggered Scan	3.128
3.3.11 Error Handling	3.136
3.4 Applications	3.137
3.4.1 Measuring the RFI Voltage	3.139
3.4.2 Measuring the RFI Current	3.143
3.4.3 RFI Fieldstrength Measurements	3.146

	Page
3.5	Program Examples 3.152
3.5.1	Initialization and Initial State 3.152
3.5.2	Sending a Device Setting Command 3.153
3.5.3	Reading of the Device Settings 3.154
3.5.4	Triggering a Single Measurement and Synchronization using *WAI 3.155
3.5.5	Service Request Routine 3.156
3.5.6	Synchronization with the End of the Scan using *OPC 3.157
3.5.7	Programming a Scan Data Set 3.158
3.5.8	Programming a Transducer Factor 3.159
3.5.9	Programming a Transducer Set 3.160
3.5.10	Output of a Test Report on Plotter 3.161
3.5.11	Block Output of Scan Results in ASCII Format 3.163
3.5.12	Block Output of Scan Results in Binary Format 3.165
3.5.13	Block Output of Scan Results in Internal Data Format (Dump) 3.169
3.6	Hints, Error Messages and Warnings 3.173

	Page
4	Maintenance and Troubleshooting 4.1
4.1	Maintenance 4.1
4.1.1	Mechanical Maintenance 4.1
4.1.2	Electrical Maintenance 4.1
4.1.2.1	Testing the Level Measuring Accuracy 4.1
4.1.2.2	Testing and Adjustment of the Frequency Accuracy 4.1
4.1.3	Replacing the Storage Battery 4.2
4.2	Function Check and Self Test 4.3
4.2.1	Switch-on Test 4.3
4.2.2	Cold Start 4.3
4.2.3	Checking the Synthesizer and the Power Supply 4.4
4.2.4	Self Test 4.4
4.3	Replacing the Modules 4.11
4.3.1	Opening the Instrument 4.11
4.3.2	Removing a Module from the Instrument 4.11
4.3.3	Fitting a Module 4.12
4.3.4	Taking the Receiver into Operation after the Replacement of a Module 4.13
4.4	Hints for Loading the Instrument Firmware 4.15
4.4.1	Introduction 4.15
4.4.2	Hardware Requirements 4.15
4.4.3	Files for FLASHUP 4.15
4.4.4	Installation 4.16
4.5	Starting the Firmware Loading Procedure 4.16

	Page
5	Testing the Rated Specifications 5.1
5.1	Measuring Equipment and Accessories 5.1
5.2	Test Run 5.2
5.2.1	Frequency Accuracy 5.2
5.2.2	RF Input 5.2
5.2.2.1	Input VSWR 5.2
5.2.2.2	Interference Voltage of the Oscillator 5.3
5.2.2.3	Interference Immunity 5.3
5.2.2.3.1	Image of the First Intermediate Frequency 5.4
5.2.2.3.2	Image of the Second Intermediate Frequency 5.4
5.2.2.3.3	Image of the Third Intermediate Frequency 5.4
5.2.2.3.4	IF Interference Immunity 5.5
5.2.2.4	Non-Linearities 5.5
5.2.2.4.1	Intercept of Third Order 5.5
5.2.2.4.2	Intercept of Second Order 5.6
5.2.3	IF Bandwidths 5.7
5.2.4	Noise Indication 5.7
5.2.5	Testing the Inherent Spurious Responses 5.8
5.2.6	Measuring Accuracy 5.8
5.2.6.1	Frequency Response 5.9
5.2.6.1.1	Indicating Mode AV 5.9
5.2.6.1.2	Indicating Mode Pk and Pk/MHz 5.9
5.2.6.1.3	Indicating Mode QP 5.11
5.2.6.2	Indication Linearity 5.12
5.2.6.3	Accuracy of the Attenuator 5.13

	Page
5.2.7	Testing the Outputs 5.14
5.2.7.1	AF Output 5.14
5.2.7.2	74.7-MHz Output 5.14
5.2.7.3	10.7-MHz Output 5.15
5.2.7.4	Envelope Output (VIDEO OUTPUT) 5.15
5.2.7.5	I/Q Outputs 5.16
5.2.7.6	Reference Output (10 MHz REF OUTPUT) 5.16
5.2.7.7	User Ports 5.17
5.2.7.7.1	Analog Outputs 5.17
5.2.7.7.2	Supply Outputs 5.17
5.2.8	Testing the Inputs 5.18
5.2.8.1	Checking the External Battery Supply 5.18
5.2.8.2	Checking the Antenna Code Socket (X3) 5.18
5.3	Performance Test Report 5.19

Supplement to Operating Manual ESVD for Firmware Version 2.17

- **Logarithmic Transducer Interpolation**

Supplement to section 3.2.4.2.2:

The interpolation of transducer factors can be performed with a linear or logarithmic frequency axis. The interpolation based on logarithmically arranged frequency values is useful with transducers showing a logarithmic curve of the conversion factor (eg bulk-current injection probes). The transducer menu offers a setting facility for this purpose. This function can be separately set for each factor. Changing to another submenu is effected by entering the frequency and level values and actuating the → key or the ENTER key.

TRANSDUCER FACTOR 01
Interpolation LIN

Actuate the ENTER key to select between logarithmic and linear interpolation. Factors with different frequency axes can be combined in a transducer set. The corresponding IEC-bus command is TRANSDUCER:INTERPOLATION LIN | LOG.

- **Test Reports on Desk-Jet and Laser-Jet Printers**

Supplement to section 3.2.4.4.1:

To output test reports Epson 24-needle, HP Desk-Jet and HP Laser-Jet II printers can be used. The IEC-bus command for selecting the printer is: PRINTER EPSON24 | LASERJET | DESKJET | CDESKJET.

The limit lines and symbols for the final test values are printed in bold to distinguish them from the grid lines.

PRINTER SETTINGS	
>Default	ON
Final Results	ON
Scan Res List	OFF
Title	ON
Scan Table	ON
Diagram	OFF
Page Count	ON
Epson 24	ON
DeskJet	OFF
LaserJet II	OFF

PLOT CONTENTS	
>Default	ON
Curve	ON
Title	ON
Diagram	ON
Final Results	OFF
Scan Table	ON
Date/Time	ON
Page Count	ON

- **Switchable Page Numbering**

Supplement to section 3.2.4.4.1:

Page numbering in the test report can be switched off. Via IEC bus: PRINTER:CONTENT:PAGE ON | OFF and PLOTTER:CONTENT:PAGE ON | OFF.

- **Switching Displays in Remote-Control Operation**

Supplement to section 3.3.4.4:

The displays can be switched on and off using the IEC-bus command DISPLAY ON | OFF. The analog instrument is then frozen on its present position.

- **IEC-Bus Command for Querying Options**

Supplement to section 3.3.4.3:

The command *OPT? queries the options of the test receiver. The return string contains several items separated by commas and showing the names of the option installed. If the option is not provided in the unit, a "0" is indicated at the corresponding position.

Order of options in the return string: ESVD-B1,ESVD-B2.

- **Direct Control of the User Ports**

Supplement to section 3.2.4.2:

The function **User Port** in the SETUP-menu has been supplemented. It leads to a submenu where the user port exits can be switched separately to HIGH or LOW level.

USER PORT	
>Port 1	Low
Port 2	High
Port 3	High
Port 4	High
Port 5	High
Port 6	High

With this function accessories can be directly controlled via the receiver.

For example, in order to control the triple frame antenna HM020 with the control line EZ-14, the user ports 1, 2 and 3 for the frames 1,2, and 3 must be switched to High, respectively.

Supplement to ESVD Data Sheet

The noise indication specified in the data sheet has been corrected and should read as follows:

Average value (AV)

B = 10 kHz, Preamplifier off < -10 dB μ V, typ. -15 dB μ V

The voltage measurement range specified in the data sheet has been corrected and should read as follows:

Average value (AV)

B = 10 kHz, Preamplifier off < -6 dB μ V, typ. -11 dB μ V

The intercept point d3 specified in the data sheet has been corrected and should read as follows:

Intercept d3 ($ f_1 - f_2 \geq 5$ MHz) dBm	Preamp off	on
	$P_{f_1, f_2} = -10$ dBm	$P_{f_1, f_2} = -20$ dBm
20 to 50 MHz	typ. +15 dBm	typ. +5 dBm
50 to 1000 MHz	> 15 dBm typ. +20 dBm	> 5 dBm typ. +10 dBm
1000 to 2050 MHz	> 13 dBm typ. +18 dBm	> 3 dBm typ. +8 dBm





ROHDE & SCHWARZ
EC Certificate of Conformity



Certificate No.: 960254

This is to certify that:

Equipment type	Order No.	Designation
ESVD	1026.5506.10	Test Receiver
ESVD-B1	1026.9001.02	I/Q Demodulator
ESVD-B2	1026.9501.02	UHF Frontend

complies with the provisions of the Directive of the Council of the European Union on the approximation of the laws of the Member States

- relating to electrical equipment for use within defined voltage limits
(73/23/EEC revised by 93/68/EEC)
- relating to electromagnetic compatibility
(89/336/EEC revised by 91/263/EEC, 92/31/EEC, 93/68/EEC)

Conformity is proven by compliance with the following standards:

EN61010-1 : 1991
EN50081-1 : 1992
EN50082-1 : 1992

Affixing the EC conformity mark as from 1992

ROHDE & SCHWARZ GmbH & Co. KG
Mühldorfstr. 15, D-81671 München

Munich, 15.10.96

Central Quality Management FS-QZ / Becker



2 Preparations for Use

2.1 Putting into Operation

2.1.1 Setting up the Receiver

If an angled power plug (R&S-stock no. DS0086.4400) and retractable supporting feet at the rear of the instrument are used, the receiver can be operated in any position.

It is however recommended to operate the receiver in horizontal position for the following reasons:

- The analog instrument achieves its highest degree of accuracy in this position.
- The LC-displays can be optimally read when seen obliquely from above; thus the best contrast can be achieved in this position.

For measurements carried out on the test bench, it is recommended to fold out the retractable feet at the bottom of the instrument.

Note: *To ensure proper operation of the receiver, note the following:*

- *Do not cover the ventilation openings!*
- *Ambient temperature -10 to +55°C*
- *Avoid moisture condensation. If it however occurs, the instrument must be wiped dry before switching-on.*

2.1.2 Rackmounting

The receiver can be mounted into 19"-racks with the help of the rack adapter, type ZZA-95 (order no. 0369.4911.00) in accordance with the mounting instructions supplied.

Note: *As the power switch is situated at the rear of the instrument, an all-pole mains disconnection must be near at hand for safety reasons when the receiver is mounted into the rack.*

2.1.3 Transport

For transport or shipping the ESVD is to be packaged in a rigid case. We strongly advise using the covering caps included in the original packing for protection of the front and rear panel, thus preventing e.g. damage to the controls on the front panel.

2.1.4 Power Supply

The receiver can be supplied either from the mains, an inserted internal battery or an external battery.

2.1.4.1 Mains Operation

The ESVD operates on A.C. supply voltages of 100 V, 120 V and 240 V $\pm 10\%$ and 230 V $+6/-10\%$ and frequencies of 47 to 420 Hz.

Prior to initial switch-on, check whether the ESVD is set to the correct supply voltage. If this is not the case, it must be set in the following way:

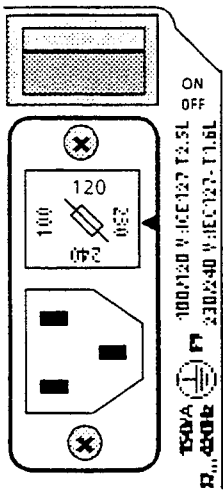

- ▶ Remove the power supply cable.
- ▶ Lever out and withdraw the cover from the voltage selector (rear panel of instrument) using a screwdriver.
- ▶ Take the fuse out of the fuse holder.
- ▶ Insert the fuse that has the necessary value (part of the accessories supplied).
A fuse IEC 127 T2.5L, is required for 100 to 120 V,
a fuse IEC 127 T 1.6 L for 230 to 240 V.
- ▶ Insert the voltage selector such that the white arrow on the fuse holder points to the desired voltage.

Fig. 2-1 Voltage Selector

2.1.4.2 Operation with Internal Battery

The ESVD can be operated on two 6-V-, 10-Ah-lead-acid batteries, which are fitted into the instrument (cf. Recommended Accessories). In mains operation (standby mode or the instrument is switched on) the batteries are charged. They also have the function of a buffer in the case of a mains failure.

Fitting the batteries:

- ▶ Unscrew 4 Philips screws of the rear panel feet and withdraw the latter.
- ▶ Remove upper and lower instrument cover backwards.
- ▶ Put the receiver on its top (RF-cabling points to the top).

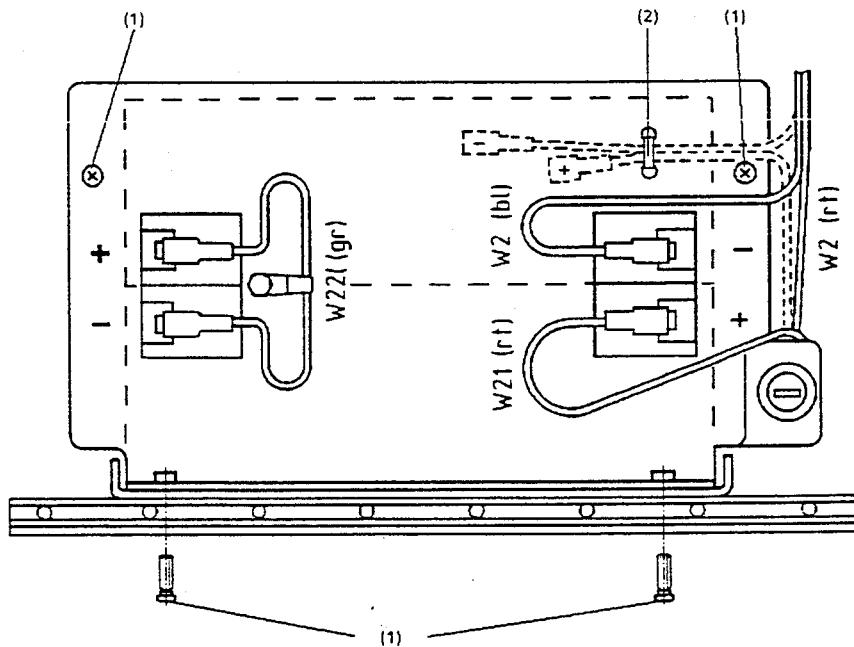

Fig. 2-2 Fitting the batteries

- ▶ Loosen the 4 screws (1) of the cover of the battery holder (two screws at the sides of the frame, two screws of the battery box).
- ▶ Remove the cover of the battery holder.
- ▶ Fit the batteries according to the mounting instructions given on the cover (Pay attention to the poling)
- ▶ Put the cover again on the battery holder and fix it using screws.
- ▶ Connect the cables to the batteries (cf. fig. 2-1).
- ▶ Check whether a suitable battery fuse (F3) is inserted.
Battery fuse: IEC 127 T 6.3L 250 V
- ▶ Slip the top and bottom housing cover on the receiver from the rear side of the housing and mount the rear panel feet by way of screwing.

The receiver can be expected to operate on internal batteries for more than two hours, if the batteries are completely charged and the ambient temperature is $> 25^{\circ}\text{C}$. If the battery voltage is less than 10.8 V, the receiver automatically switches off to avoid harmful overdischarging of the batteries. Following switch-off the STANDBY-LED on the front panel flashes to indicate that the batteries must be charged.

The discharge degree of the batteries can be checked on the display device by pressing the key BATTERY (Fig. 3-1). If the pointer is at the left end of the bold bar (dotted line in fig. 2-3), the battery is almost exhausted. The instrument is near to switching-off. If the pointer is in the upper third of the bar (dashed line in fig. 2-3), the battery is completely charged. During charging the pointer is in the range of the thin bar (dashed-dotted line in fig. 2-3; temperature-dependent end of charge of the batteries).

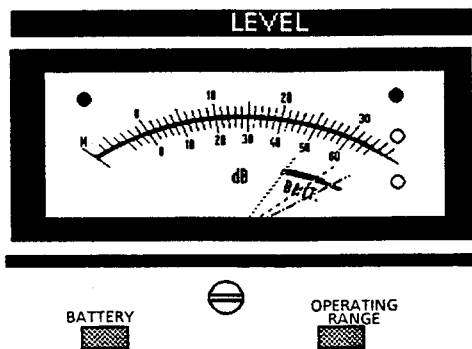

Fig. 2-3 Charge of the batteries

Note: *It is recommended to store the batteries in charged condition, if possible. Batteries that are stored must be recharged after about 12 months, if the average ambient temperature is $+20^{\circ}\text{C}$. The higher the temperatures, the shorter the period after which recharging is necessary.*

The batteries should be stored in dry environment, as moisture leads to conducting compounds between the connecting poles and thus increases self-discharge.

If the batteries are permanently used at high temperatures, their service life is reduced. Permanent capacity losses may arise. Continuous use at temperatures above $+50^{\circ}\text{C}$ should therefore be avoided.

The display light and IEC bus are not switched off automatically when supplying the test receiver from an internal battery. We recommend you to switch them off by way of special functions 10 and 11 in order to increase the battery life.

2.1.4.3 Operation with External Battery

The instrument can be supplied from an external d.c. voltage source via the connector "BATTERY 11...33 V" situated at the rear of the instrument. Due to the wide voltage range it can be supplied both from a 12-V-battery and a 24-V-battery. The battery connector required is contained in the accessories supplied. The battery is connected to the instrument in the following way:

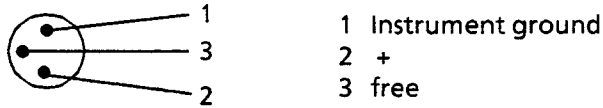

(View of solder side)

Fig. 2-4

The receiver is protected against reverse voltage applied to the battery connector, i.e. a wrongly connected supply will not lead to damages.

Substitute fuses for operation with external battery are contained in the accessories (IEC 127 T 6.3L 250 V).

If the A.C. supply is connected to the receiver at the same time, the latter is supplied only from this supply. The external battery is then not charged. Battery back-up with external battery is possible, but whenever it is switched from A.C. supply to external battery an instrument reset may, however, occur.

During operation the external battery voltage can be continuously increased from 11 V to 33 V without the instrument switching off. When however the voltage is increased to more than 15.5 V or decreased to under 14.5 V, an instrument reset occurs, which is due to the internal switch-over of the switching power supply from 24-V-operation to 12-V-operation. When the receiver is supplied from a 12-V- or 24-V- battery, this is not of importance as in this case the voltages stated above never occur. If the instrument is however operated on an external generator, this fact must be considered.

Note: The ESVD can be switched on only when a voltage of at least 12 V is available at the socket for connection of a battery. During operation, the voltage may decrease to 11 V. The reason is an internal switch-on hysteresis preventing the receiver from being continuously switched on and off with the battery being almost discharged.

2.1.5 Switching-on

a) A.C. supply operation:

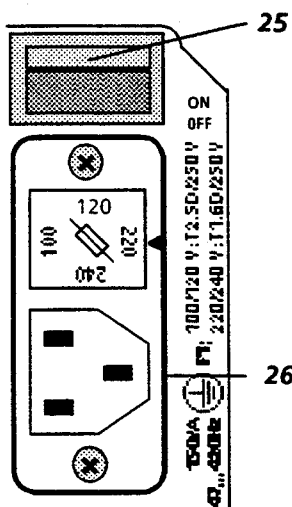

- ▶ Connect the mains cable to the mains connector **26** (rear panel of instrument).
- ▶ Press rocker switch **25** (rear panel of instrument) to ON. If the instrument is supplied from the mains, the LED STANDBY on the front panel flashes. It also indicates whether an internal battery that may be available is being charged and the internal and the oven-controlled crystal oscillator is being heated.
- ▶ Press the switch-on key. The receiver is switched on and the LED ON on the front panel flashes. When the power supply functions correctly, the LED "SUPPLY OK" at the rear panel of the instrument flashes. It also indicates that all internal voltages are within the permissible range.

Fig. 2-5

b) Operation with internal or external battery

If the receiver is operated on internal or external battery (A.C. power supply is not connected), the instrument is switched on using the ON STANDBY switch on the front panel (pos. 9, cf. fig. 3-1). The power switch on the rear panel is without any meaning. If the instrument is switched on, the LED ON flashes. If the voltage of the internal battery or the external supply is not sufficient for operation, the LED STANDBY flashes and thus indicates that the battery must be charged.

Following switch-on the following text appears on the display DATA INPUT:

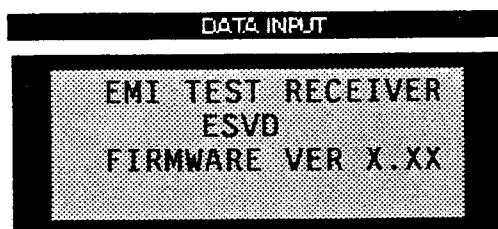

Fig. 2-6 Display after switching on

The receiver is set to basic setting and shows the level applied to the RF-input.

2.2 Function Test

The function test of the ESVD is carried out in the following stages:

- Automatic test when switching-on the receiver,
- Total calibration, which ensures correct operation when it has been successfully completed, and
- Self-test, which checks all of the modules at significant points and indicates errors via display, once it is called by the user.

When switching-on the receiver all functions of the processor are initialized and thus simultaneously checked and the test A/D-converter automatically adjusted.

Information on the calibrations is given in section 3.2.3.12, self-tests and error messages are described in section 4.

Cold Start:

All the functions of the ESVD are set to their default status by pressing the decimal point in the numeric keypad during switch-on. As a result the memory with battery back-up is cleared, i.e. all the stored settings, limit lines and transducer factors get lost. An extensive test of the controller hardware is subsequently performed in addition to the usual switch-on test. During this process the message *INICOLD* is read out in the LEVEL display. If an error in the processor hardware, which permits further operation, was detected, the message *ERRCPU* is output in the DATA INPUT display. The message can only be deleted by switching off and again on the ESHS.

After having successfully concluded the extended switch-on test, the receiver is set to its default status.

Note: After a "cold start" of the receiver (or when a new firmware has been loaded), a total calibration is to be performed as the correction values were completely erased.



3 Operating Instructions

3.1 Explanation of Front and Rear Panel View

3.1.1 Front View

1

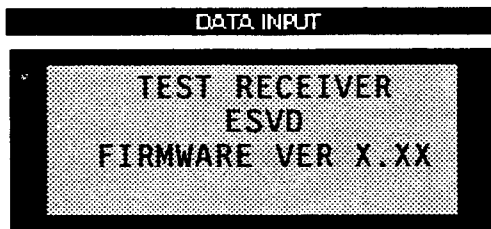

Menu input display for ANALYSIS, INSTR STATE and REPORT, 4 lines with 20 characters each, editing with DATA (cf. section 3.2.2)

2

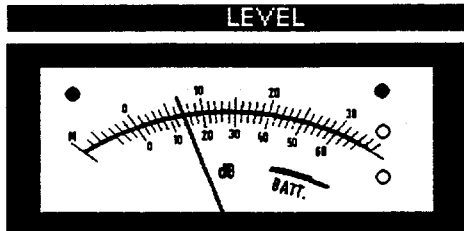

- Moving coil instrument with scales for the 30-dB- and 60-dB-operating ranges;
- Display of battery voltage and mechanical zero display;
- Setting screw for the mechanical zero;
- Yellow LEDs for indicating the operating range;
- Red LEDs for indicating whether the operating range (upper or lower limit) is exceeded (cf. section 3.2.7.3)

3



BATTERY: Key for indicating the charge of battery (cf. section 2.1.3.2)

OPERATING RANGE: Key for switching-over the operating range (cf. section 3.2.3.6)

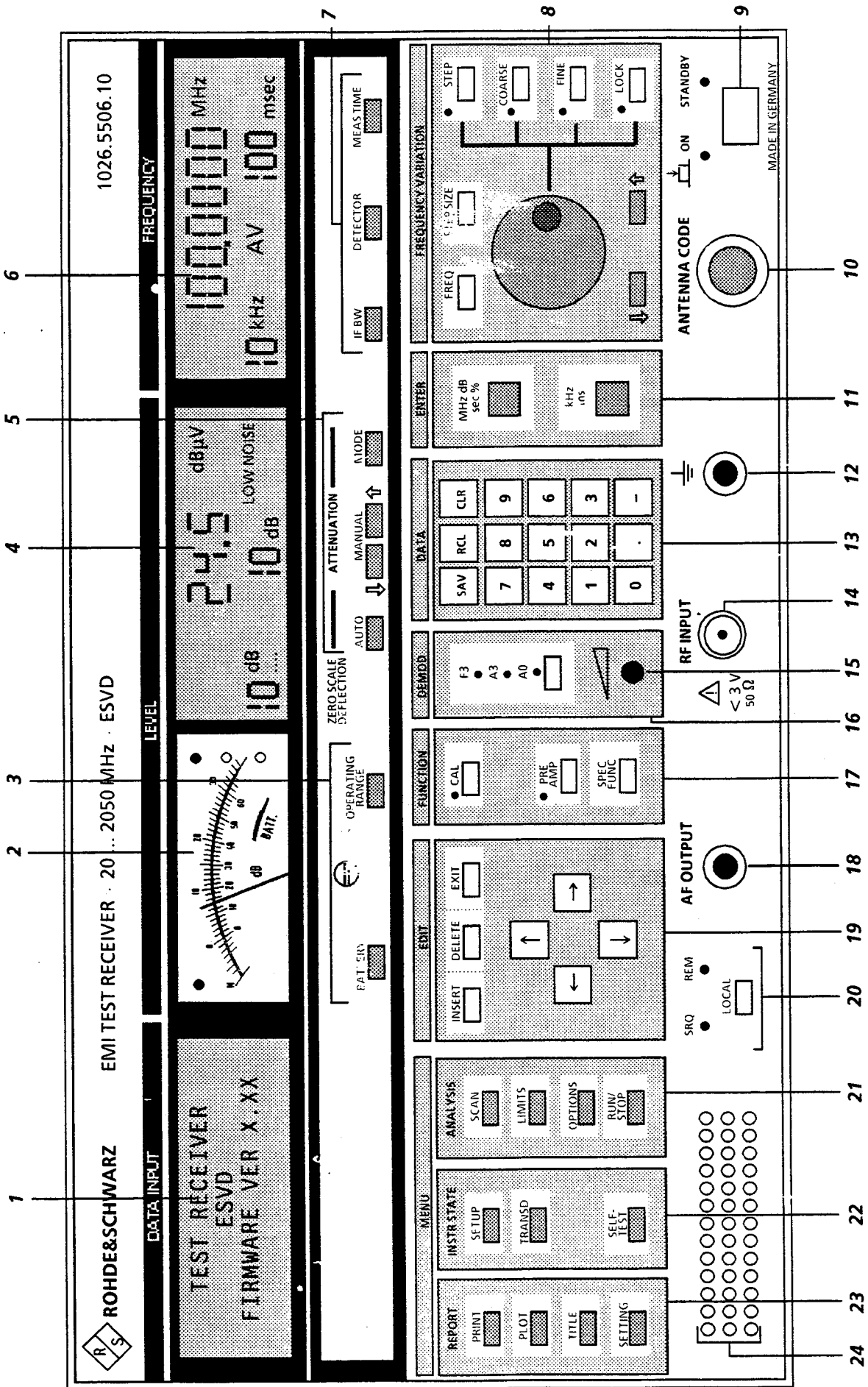
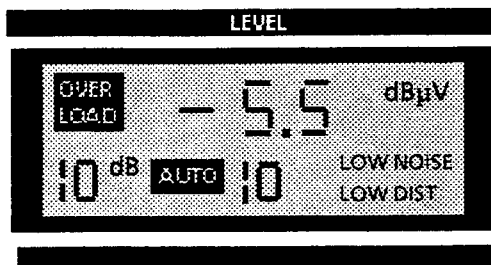

Fig. 3-1 Front panel view



ZERO SCALE
DEFLECTION

- 3 1/2-digit display of the level applied to RF-input, resolution 0.1 dB
Units:
dB μ V, dB μ A, dBm, dB μ V/MHz, dB μ A/MHz, dB μ V/m, dB μ V/m/MHz, dB μ A/m, dB μ A/m/MHz, dBpW
- Display of overload of the signal path (OVERLOAD)
- Display of measurement mode (MODE): LOW NOISE and LOW DIST (low-distortion) (sect. 3.2.3.3)
- Display of RF attenuation (RF ATT) 0 to 120 dB (cf. section 3.2.3.2)
- Display of automatic operation (AUTO) (cf. section 3.2.3.5)
- Instrument display of lower limit of the scale span (ZERO SCALE DEFLECTION) (cf. section 3.2.3.7)



Attenuation

AUTO: RF-attenuation and MODE are automatically adjusted to input signal (cf. section 3.2.3.5)

MANUAL: Switch-over of RF-attenuation:
↑ increasing by 10 dB, ↓ decreasing by 10 dB (cf. section 3.2.3.2)

MODE: Switch-over of IF-attenuation (LOW NOISE/LOW DISTORTION) (cf. section 3.2.3.3)

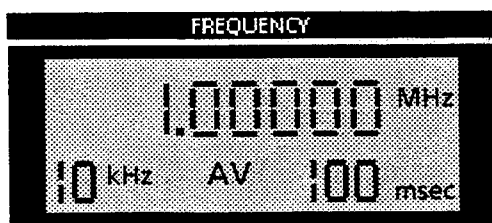

- 8-digit display of receiver frequency resolution 100 Hz, unit in MHz (cf. section 3.2.3.1)
- Display of measuring time, 1 ms to 100 s in 1, 2, 5-steps, (cf. section 3.2.3.10)
- Indication of detector: AV, Pk, Pk/MHz and QP, (cf. section 3.2.3.9)
- Indication of IF-bandwidths 10 kHz, 120 kHz, 300 kHz and 1 MHz (cf. section 3.2.3.8)

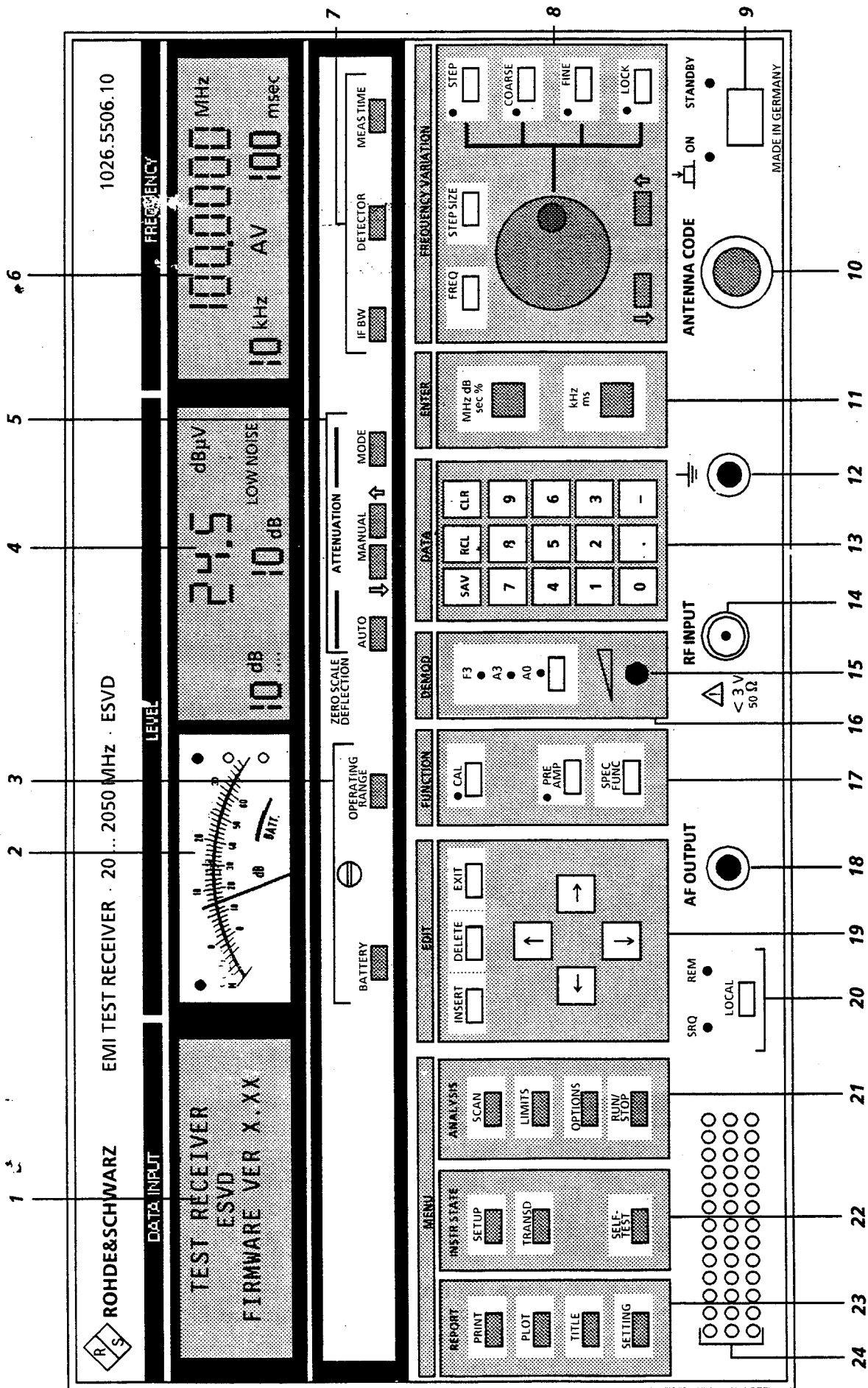

Fig. 3-1 Front panel view

7



- IF BW: Key for switching over IF-bandwidth
- DETECTOR: Key for switching over the weighting (cf. sect. 3.2.3.9)
- MEAS TIME: Key for activating input of measuring time (cf. section 3.2.3.10)

8

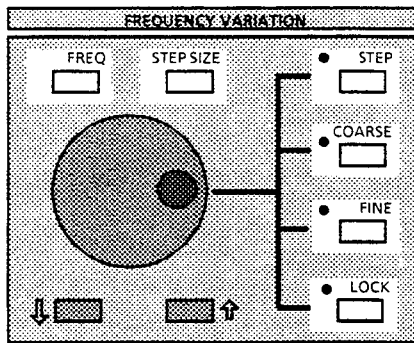

- Frequency tuning knob
- FREQ: key for input of frequency
- STEP SIZE: Input of tuning step size
- STEP: Tuning in the step size entered in STEP SIZE
- COARSE: Frequency tuning coarse (100-kHz steps)
- FINE: Frequency tuning fine (100-Hz steps)
- LOCK: Frequency tuning fine (100-Hz steps)
- ↑: Frequency is increased by the step size entered in STEP SIZE
- ↓: Frequency is reduced by the step size entered in STEP SIZE (cf. section 3.2.3.1)

9

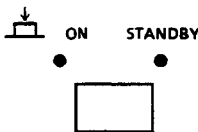

On/Standby switch

10



- Supply and code socket for connecting active and passive measuring transducers:
- Output: + 10 V, -10 V, max. 50 mA
- Input: Coding for level display (cf. section 3.2.5.1)

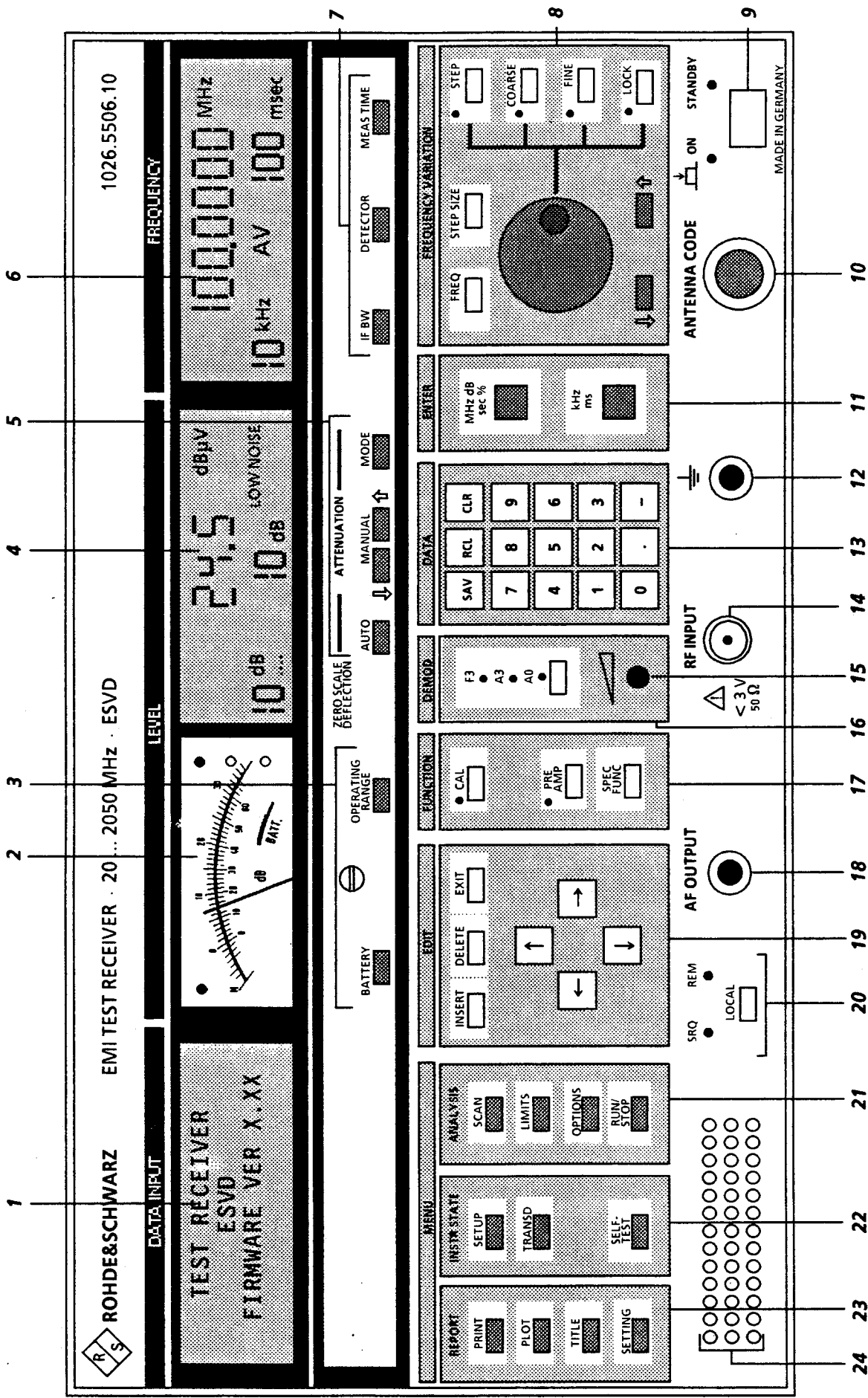
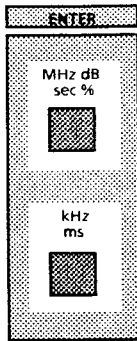

Fig. 3-1 Front panel view

11



Input keys:

MHz dB

sec %: Input key for the units MHz, dB, seconds and % or for entries without unit

kHz

ms: Input key for the units kHz and milliseconds or for entries without unit (cf. section 3.2.2)

12



Socket for connecting measuring earth

13

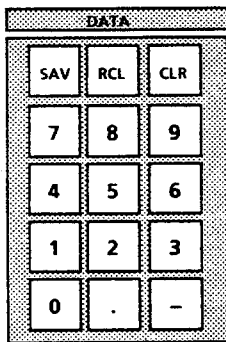

Numeric keypad

SAV (0 to 9): Storing of instrument settings (cf. section 3.2.4.5)

RCL (0 to 9): Calling of stored settings (cf. section 3.2.4.5)

CLR: Deleting the character last entered

0 to 9: Numeric input keypad

- Minus sign

. : Decimal point (cf. section 3.2.2)

14

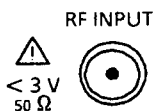

RF-input, N-input socket, 50 Ω, < 3 V (cf. section 3.2.1)

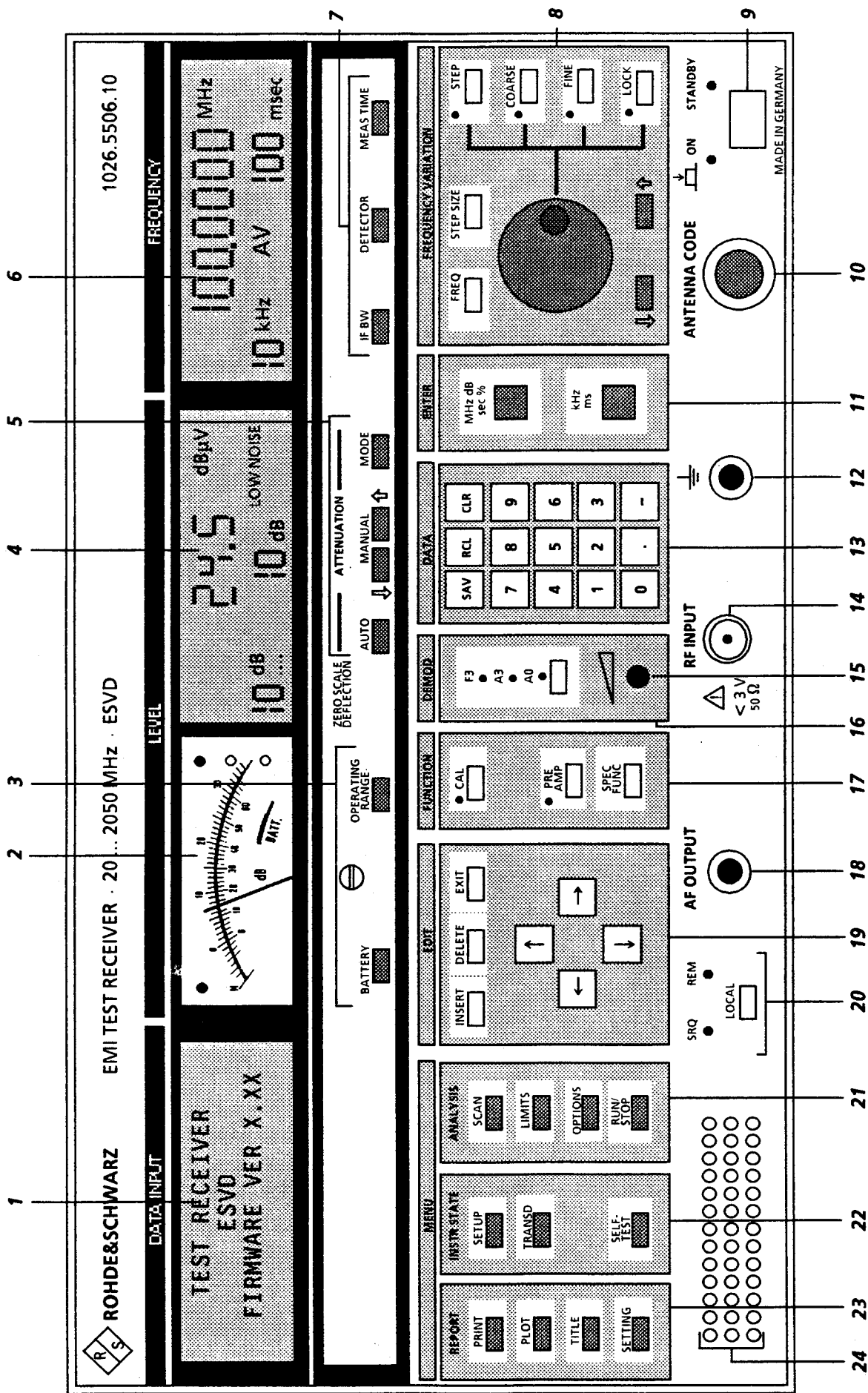

Fig. 3-1 Front panel view

15



Rotary knob for setting the volume.
(cf. section 3.2.3.11)

16

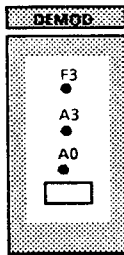

F3 Indicates when FM-demodulation is switched on.
A3: Indicates when AM-demodulation is switched on
A0: Indicates when A0-demodulation is switched on
Key for switching-over the mode of demodulation
(cf. section 3.2.3.11)

17

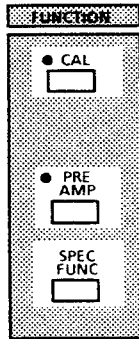

CAL: Initiating calibration process
short key depression → short calibration
long key depression → total calibration (cf. section 3.2.3.12)
PREAMP: ON/OFF-switch for preamplifier
(cf. section 3.2.3.4)
SPEC FUNC: Calling the special function menu
(cf. section 3.2.3.13)

18

AF OUTPUT



AF-output connector (JK 34)
with break contact for loudspeaker;
 $R_i = 10 \Omega$; emf > 1.5 V

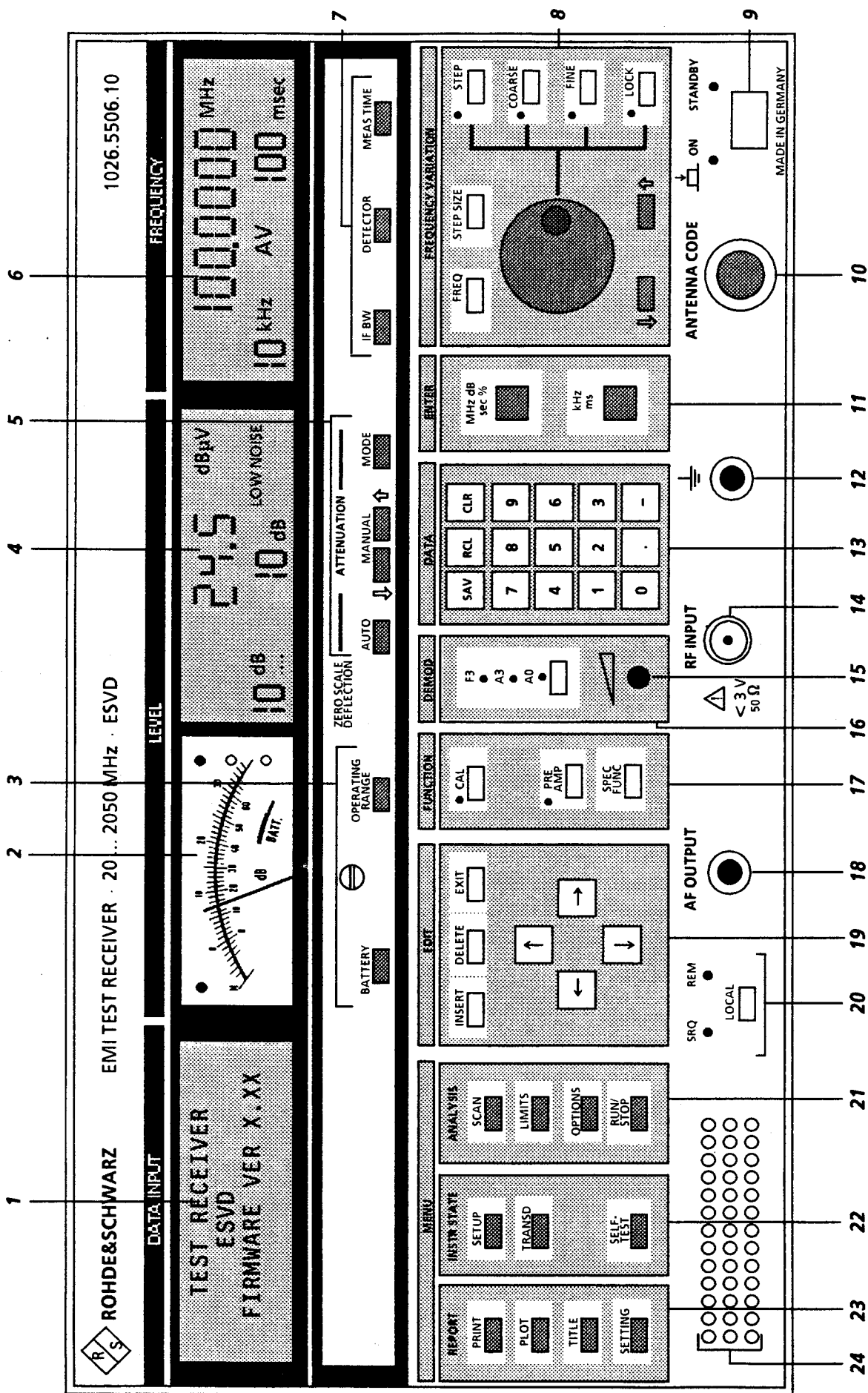
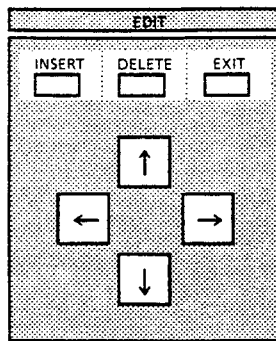
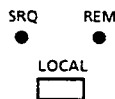

Fig. 3-1 Front panel view



Editing function of display DATA INPUT:

- EXIT:** Exiting the current menu (cf. section 3.2.4.1)
- INSERT:** Inserting in already existing lists (cf. section 3.2.4.1)
- DELETE:** Deleting input lines or -characters (cf. section 3.2.4.1)
- :** The cursor moves to the right or to the next submenu, (cf. section 3.2.4.1)
- ←:** The cursor moves to the left or one menu back, (cf. section 3.2.4.1)
- ↑:** The cursor moves one line up (cf. section 3.2.4.1)
- ↓:** The cursor moves one line down (cf. section 3.2.4.1)



- SRQ:** LED indicates service request present at IEC-bus (cf. section 3.3)
- REM:** LED for indicating remote control of ESHS (cf. section 3.3)
- LOCAL:** Key for switching from remote control to manual operation (cf. section 3.3).

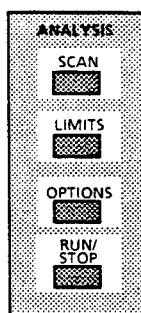

- SCAN:** Calling the menu for input of scan data sets (cf. section 3.2.4.1.1)
- LIMITS:** Calling the menu for input of limit lines (cf. section 3.2.4.3.2)
- OPTIONS:** Calling the menu for input of special measurements and complex procedures (cf. section 3.2.4.3.3)
- RUN/STOP:** Key for starting or stopping a frequency scan (cf. section 3.2.4.3.4)

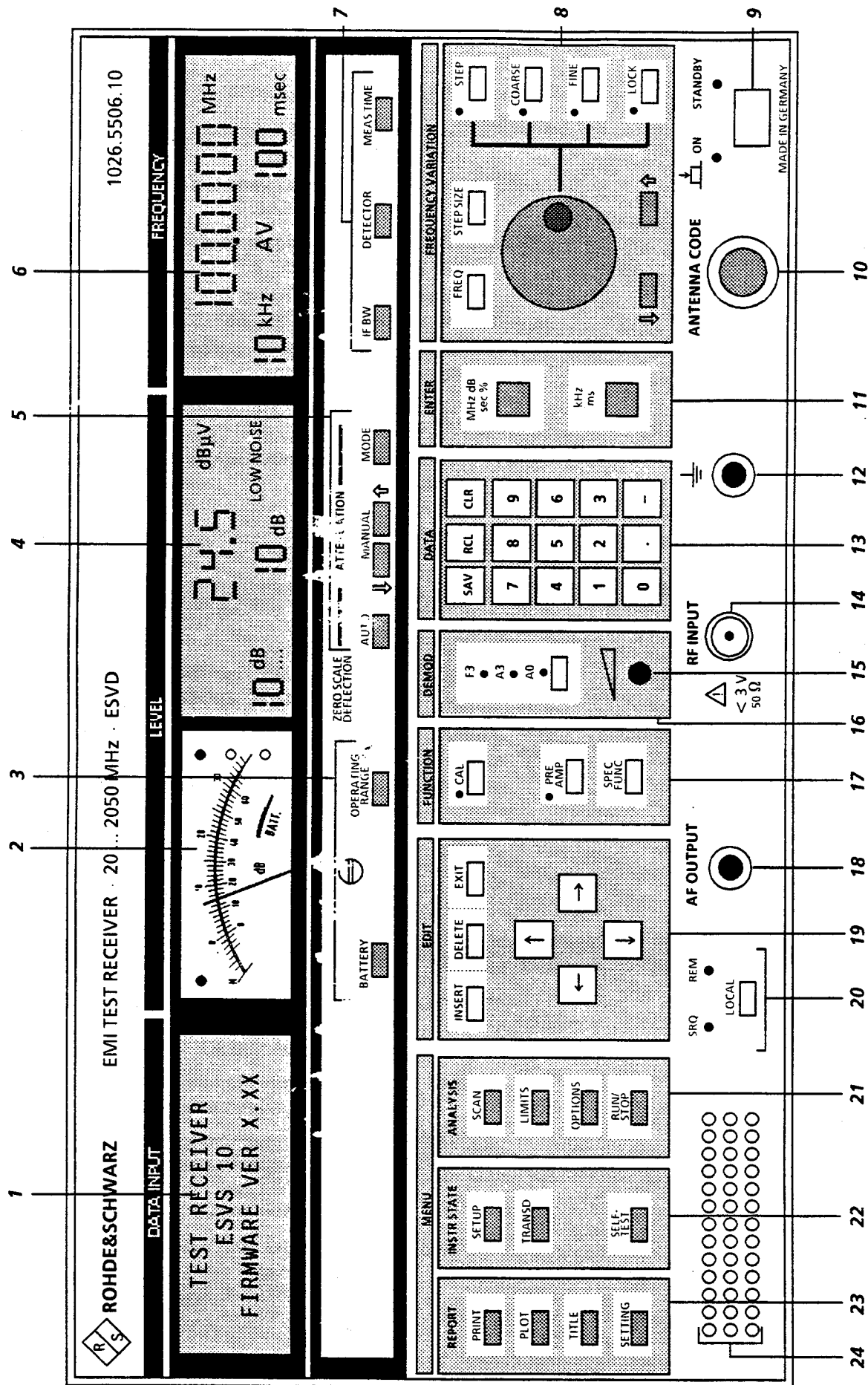
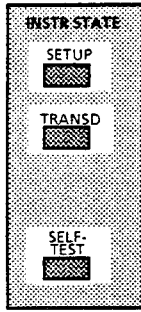
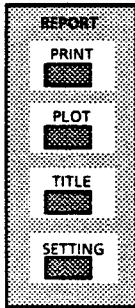

Fig. 3-1 Front panel view



- SETUP: Calling the menu for the instrument default settings (cf. section 3. 2. 4. 2.1)
- TRANSD: Calling the menu for input of transducer factors (cf. section 3.2.4.2.2)
- SELF TEST: Calling the menu for instrument self-test (cf. section 3.2.4.2.3)



- PRINT: Starting printer output (cf. section 3. 2. 4. 4. 3)
- PLOT: Starting plotter output (cf. section 3.2.4.4.4)
- TITLE: Calling the menus for input of headers for printer or plotter output (cf. section 3.2.4.4.2)
- SETTING: Calling the menu for presetting the instrument for plotter and printer outputs (cf. section 3.2.4.4.1)

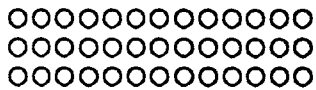

Internal loudspeaker, which is switched off when a connector is inserted into the socket AF OUTPUT.(18)

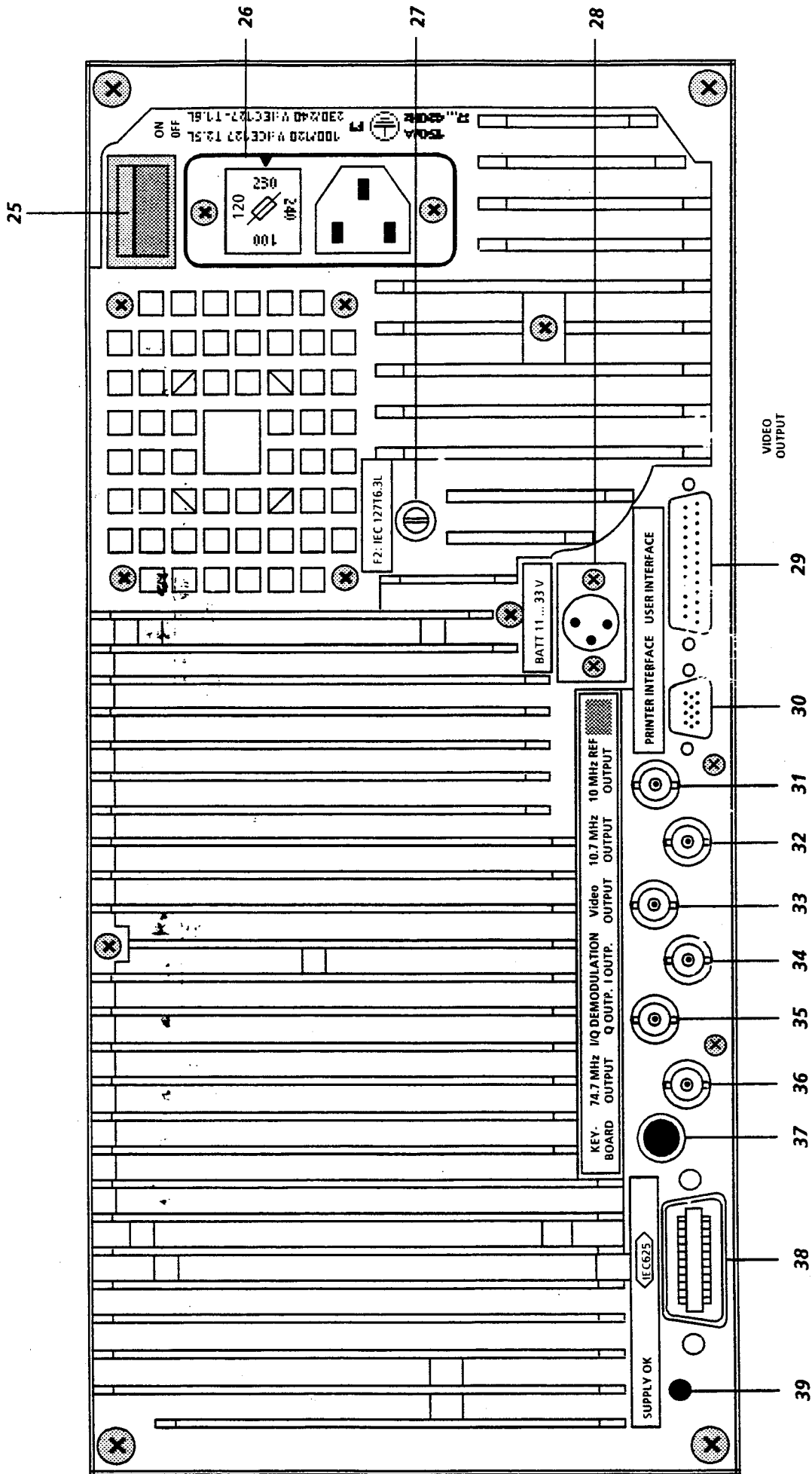
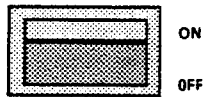

Fig. 3-2 Rear panel view

3.1.2 Rear View

25



Power switch

26

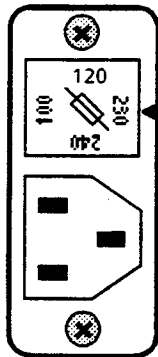

Power input with integrated voltage selector and power fuse (cf. section 2.1.3.1)

27

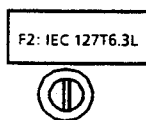

Fuse for external battery,
IEC 127T6.3L 250 V
(cf. section 2.1.3.3)

28

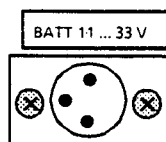

Input for an external battery 11 to 33 V,
3-pole special connector; (cf. section 2.1.3.2)

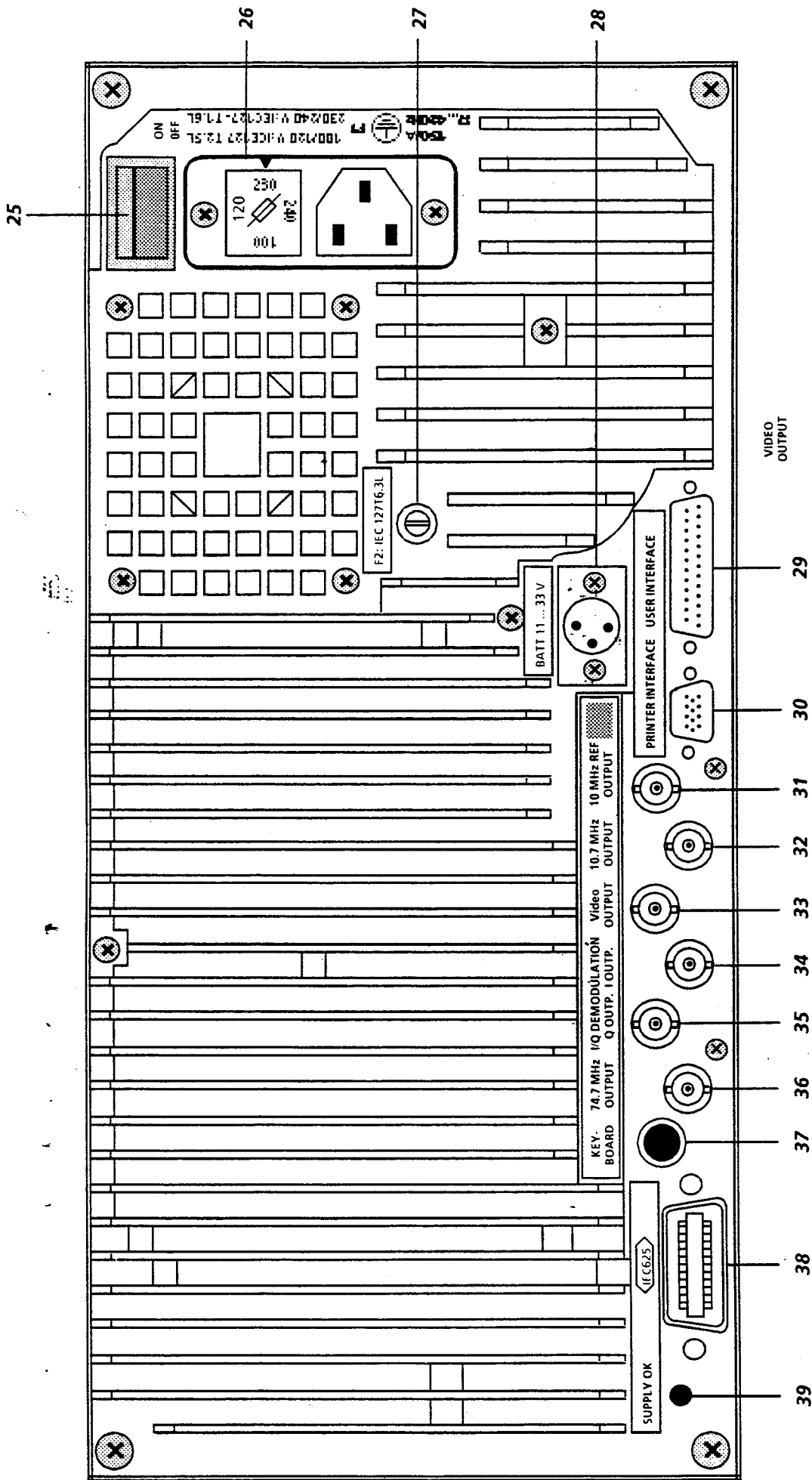

Fig. 3-2 Rear panel view

29

USER INTERFACE



User interface with various inputs and outputs, 25-pole female connector (cf. section 3.2.6.6)

30

PRINTER INTERFACE

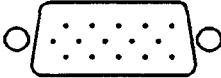

Parallel interface for connecting a printer, 15-pole female connector (cf. section 3.2.6.7)

31

10 MHz REF
OUTPUT



BNC socket, output of the internal oven-controlled crystal oscillator (10 MHz, cf. section 3.2.6.4)

32

10.7 MHz
OUTPUT



BNC socket for output of the 2nd IF (10.7 MHz) (cf. section 3.2.6.2)

33

VIDEO
OUTPUT



BNC output socket for the demodulated IF-signal (envelope) (cf. section 3.2.6.3)

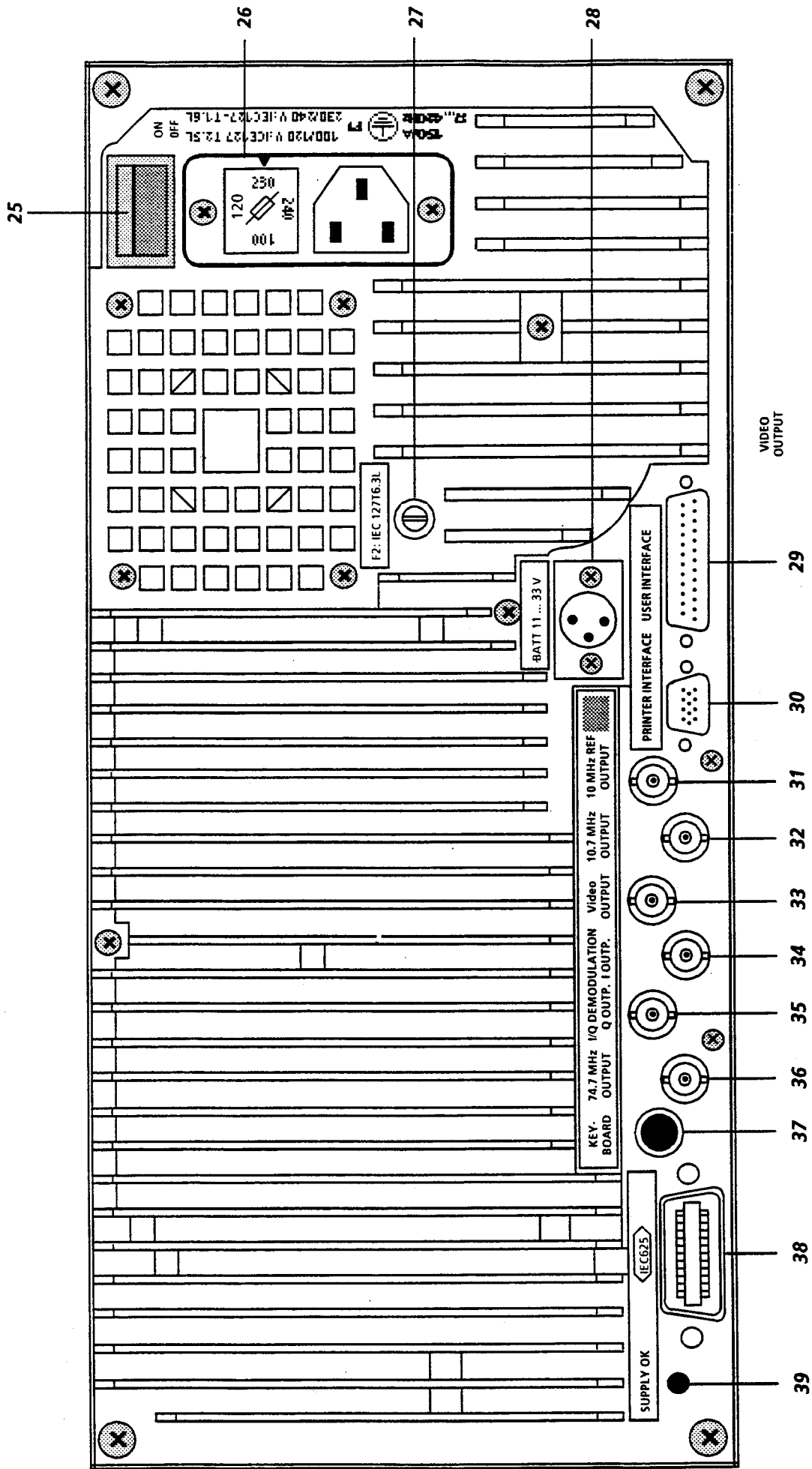

Fig. 3-2 Rear panel view

34

I OUTPUT



BNC socket, output of the in-phase component of the baseband signal (only with ESVD-B1 option) (cf. section 3.2.6.5)

35

Q OUTPUT



BNC socket, output of the quadrature component of the baseband signal (only with ESVD-B1 option) (cf. section 3.2.6.5)

36

74.7 MHz
OUTPUT



BNC socket for output of the 2nd IF (74.7 MHz) for connecting a panoramic monitor (cf. section 3.2.6.6)

37

KEYBOARD



Connection for external keyboard (cf. section 3.2.6.9)

38

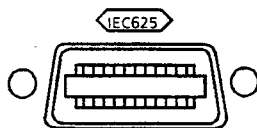

IEC-bus interface, 25-pole female connector (cf. section 3.2.6.8)

39

SUPPLY OK



LED flashes when all the internal supply voltages of the power supply are correct.

3.2 Manual Operation

Manual operation of Test Receiver ESVD can be divided into two groups: operation of the receiver functions and that of the menus calling complex measurement runs.

The receiver functions are:

- frequency input,
- selecting attenuation (RF attenuation and IF attenuation),
- selecting IF bandwidth,
- selecting weighting mode (detector),
- selecting measuring time,
- selecting operating range,
- selecting AF demodulation,
- testing the internal battery,
- level indication (analog and digital),
- calibration of receiver,
- switching-on of pre-amplifier and
- use of the various special functions.

The menus include:

- selecting the receiver configuration,
- use of transducer factors (transducer),
- setting and performing frequency scans,
- input of limit lines,
- carrying out special measurements (OPTIONS) during frequency scan,
- output of measurement results on printer or plotter,
- input of headers for printer- or plotter outputs,
- setting the printer or plotter configuration and
- carrying out the self-test.

3.2.1 Connecting the Voltage to be Measured

The voltage to be measured is connected to the RF INPUT via a 50- Ω -coaxial cable. The input resistance of the receiver is 50 Ω . The ESVD measures sinusoidal and pulse voltages within the frequency range of 20 MHz to 1000 MHz (2050 MHz with Frequency Extension ESVD-B2). The total voltage of all signals that may be applied to the input socket of the receiver without causing any permanent damage depends on RF attenuation (cf. Specifications).

3.2.1.1 Sinusoidal Signals and DC Voltage

With an RF attenuation of 0 dB the RMS value of the total voltage applied to the RF input may not exceed 3 V at 50 Ω . For RF attenuations ≥ 10 dB the total voltage may not be more than max. 7 V. The instrument is designed for a max. dc voltage of 7 V with all RF attenuations (dc coupling).

3.2.1.2 Pulse Signals

With an RF attenuation of 0 dB the pulse spectral density must not exceed 97 dB μ V/MHz at 50 Ω . As described in section 3.2.3.5 (autorange operation), after switch-on of the receiver, RF attenuation is more than 10 dB, if attenuation is set automatically. If, however, RF attenuation was manually set to 0 dB, this value is also used in autorange operation. Manual setting of RF attenuation prevents that an RF attenuation of 0 dB is activated during autorange operation.

With an RF attenuation > 0 dB the max. permissible pulse energy at 50 Ω is 1 mWs with a pulse duration of 10 μ s.

The input attenuator, pre-amplifier, preselection filter or input mixer may be destroyed, if these values are exceeded.

3.2.2 Input of Numeric Values

The numeric keypad DATA (pos. 13, cf. fig. 3-1) and the unit field ENTER (pos. 11) are used for the input of figures both in the receiver part and menu part.

The keys SAV and RCL that serve to save and call instrument settings are dealt with in section 3.2.4.5. Numeric values are input in accordance with the following flowchart:

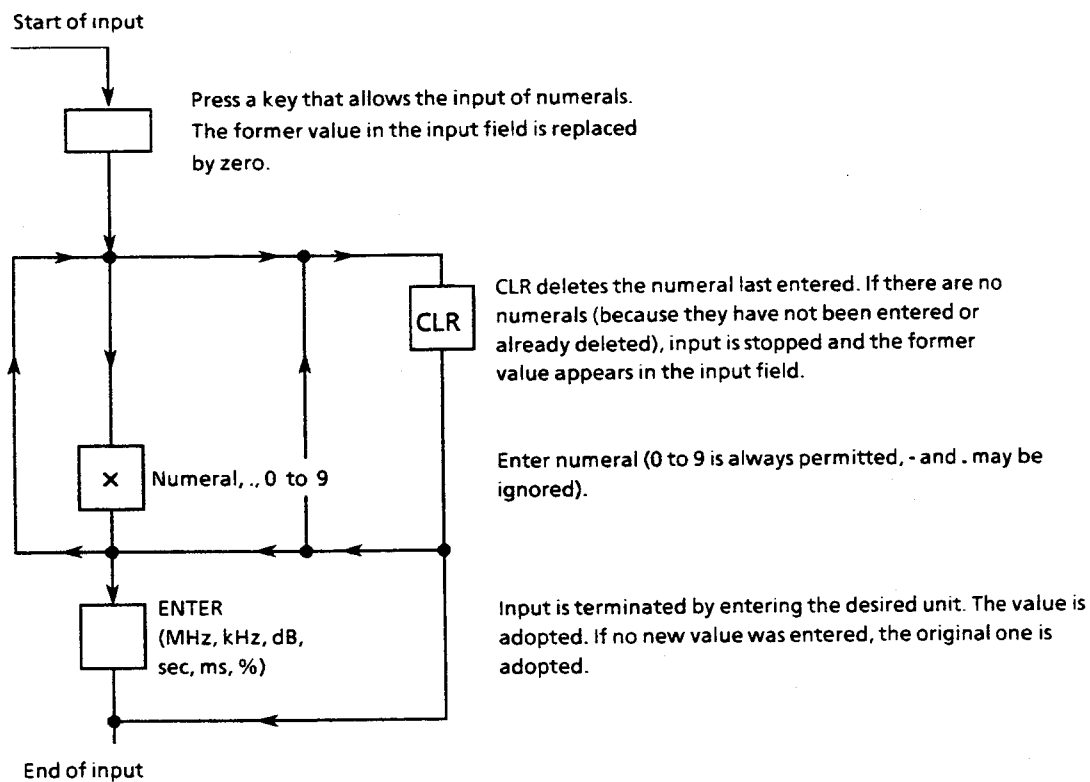

Fig. 3-3 Flowchart for the input of numeric values

3.2.3 Operation of the Receiver Functions

3.2.3.1 Setting the Receiver Frequency

The frequency of the receiver can be entered using the rotary knob, the upward/downward keys or via the numeric keypad (**13**) after having pressed the **FREQ** key. When setting frequency with rotary knob, frequency increment or decrement is selected using the functions **STEP**, **COARSE** and **FINE**.

3.2.3.1.1 Numeric Input of Frequency

The desired receiver frequency in the range of 20 MHz to 1000 (2050) MHz can be entered directly using the **FREQ** key in the keypad **FREQUENCY VARIATION**. Following the activation of the **FREQ** key, the current receiver frequency, which is shown in the display **FREQUENCY**, is cleared and a new one can be entered as described in section 3.2.2.

3.2.3.1.2 Frequency Setting using the Rotary Knob

The rotary knob in keypad **FREQUENCY VARIATION** serves only for varying the frequency. Independently of any other selected input function, the frequency can always be tuned using this knob.

The step size with which frequency is tuned can be selected using the keys **STEP**, **COARSE**, **FINE** and **LOCK**. The step size selected is indicated by an LED next to the corresponding key. Tuning is performed in the step sizes given in the following table:

Table 3-1:

Tuning in Position	Step Size
COARSE	100 kHz
FINE	100 Hz
LOCK	Rotary knob is blocked
STEP	0 to 1000 (2050) MHz (cf. section 3.2.3.1.4)

When the rotary knob is turned slowly, every step between detent positions corresponds to a frequency step. To allow for comfortable tuning of the receiver over relatively wide frequency ranges, tuning is additionally accelerated when the knob is turned quickly.

3.2.3.1.3 Frequency Tuning using the ↓ and ↑ keys

If signals in known frequency steps are to be measured, it is useful to step through the receiver frequency in their distance. This is for example the case with harmonics of the clock frequency of processors. For this purpose the ↓ and ↑ keys are provided in the keypad FREQUENCY VARIATION. Frequency is changed in the step sizes entered with the help of STEP SIZE (cf. section 3.2.3.1.4) using these keys. In addition the receiver frequency can be fine-tuned using the rotary knob in position FINE, when for example the maximum of a harmonic wave is to be determined in the case of a source that is not frequency-stable. Fine-tuning is taken into account when changing the frequency the next time using the ↓ and ↑ keys, i.e. the receiver proceeds taking the new frequency as basis.

3.2.3.1.4 Input of Tuning Step Size

Any step size for tuning the receiver frequency can be input using the STEP SIZE key in the keypad FREQUENCY VARIATION. The defined step size is used when tuning the frequency with the ↓ and ↑ keys or with the tuning knob in the step size setting STEP.

Operation:

Step size is entered as follows:

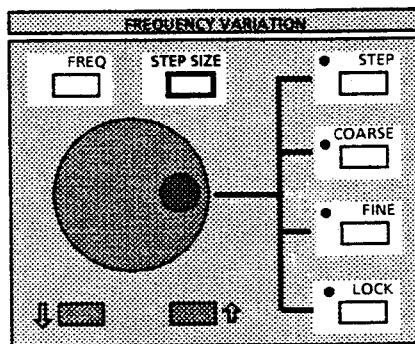

► Press STEP SIZE key.

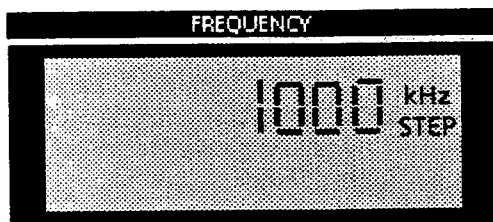

The frequency in the display FREQUENCY disappears and instead the step size currently set is indicated with the additional remark *STEP*.

When entering a figure the former step size is no longer displayed and the figure is shown in the display (input cf. section 3.2.2)

The step size is variable between 0 kHz/MHz and 1000 MHz (2050 with Frequency Extension ESVD-B2). After termination of input, the receiver frequency is shown again in the display FREQUENCY with the unit MHz or kHz.

3.2.3.2 Selecting RF Attenuation (ATTENUATION)

Attenuation of the RF input divider can be set in 10-dB steps in the range of 0 to 120 dB. The test receiver may have somewhat less accuracy in the 0-dB position as a result of the higher input reflection coefficient ($VSWR < 2$). In the case of quasipeak measurements in accordance with CISPR 16, minimum attenuation of 10 dB must therefore be switched on ($VSWR < 1.2$).

Operation:

RF attenuation is increased or decreased in 10-dB steps using the \downarrow and \uparrow keys in the ATTENUATION keypad. When pressing the respective key for a longer time (> 1 s) the repetition function is switched on, i.e. attenuation is stepwise switched.

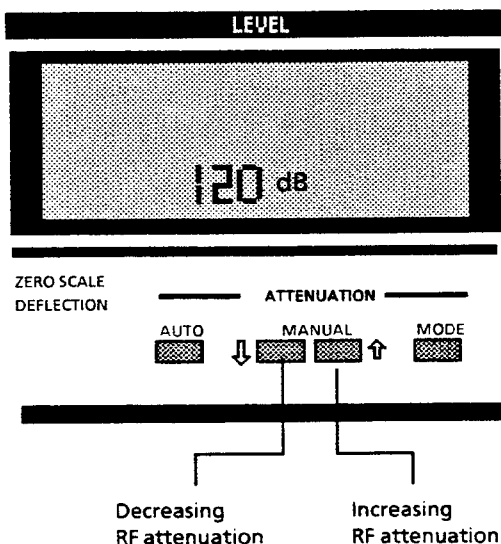

The RF attenuation selected is shown in the LEVEL display.

3.2.3.3 Selecting the Operating Mode (MODE)

The ESVD provides the operating modes LOW NOISE (low-noise measurement) and LOW DISTORTION (low-distortion measurement). When measuring in the latter mode IF gain of the receiver is set such that the noise indication is always below the beginning of the meter scale (ZERO SCALE DEFLECTION) or when measuring with preamplifier it is set such that it is in proximity to zero scale deflection of the instrument. The set IF gain depends on the indicating mode and the IF bandwidth. In the mode LOW NOISE, IF gain is 10 dB less, i.e. the signal-to-noise ratio for signals in the valid indication range is 10 dB higher than in the operating mode LOW DISTORTION.

LOW DISTORTION should be used for small signals in the presence of high interference signals or when measuring broadband interference in the indicating modes Pk/MHz and Quasipeak with low pulse frequency. To obtain the same deflection at the instrument as in the operating mode LOW NOISE, RF attenuation must be selected 10 dB higher. Signals that are 10 dB lower are applied to the input mixer, which is thus less loaded.

For uncritical measurements the setting LOW NOISE is to be preferred as a higher degree of accuracy can be expected due to the higher signal-to-noise ratio.

Operation:

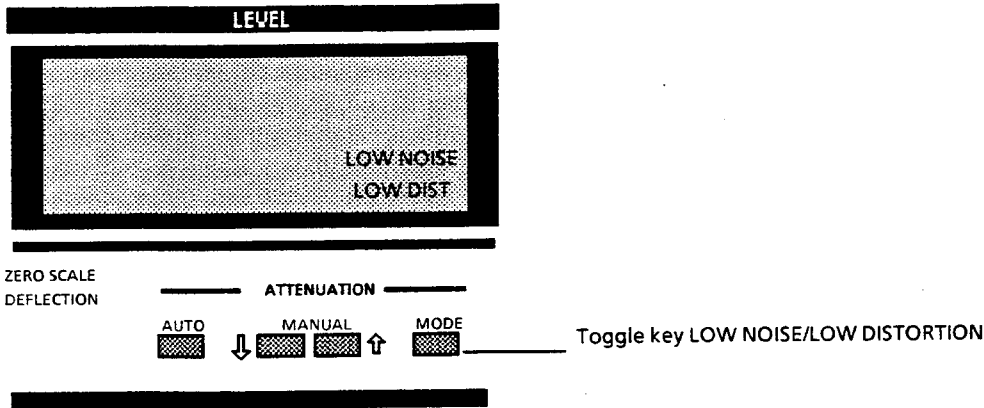

The set mode is shown in the LEVEL display.

3.2.3.4 Operation with Preamp (PREAMP)

The preamplifier of the ESVD is between preselector and first mixer. It reduces the noise figure of the receiver from typically 12 dB to typ. 8 dB. Due to its high loading capability the preamplifier itself does not affect the dynamic range of the receiver. However, with pre-amplifier the level at the first mixer is 10 dB higher. Therefore total loading capability is reduced by about 10 dB.

As a result the dynamic range is reduced by approx. 6 dB (4 dB less noise and a maximum level that is reduced by 10 dB) when carrying out quasipeak or broadband interference measurements.

It is recommended to use the preamplifier when signals in proximity of the inherent noise of the receiver are to be measured or when, in the case of medium-range levels, the measurement error is to be reduced with the help of a higher signal-to noise ratio.

In the case of coverage measurements in mobile radio service networks, it is generally recommended to use the preamplifier, since the same sensitivity as mobile radiotelephones exhibit can be achieved while its loading capability is increased.

Operation:

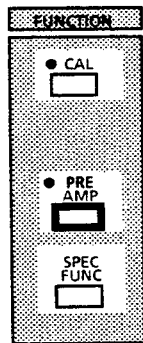

- ▶ Press PREAMP key. The state of the preamplifier is switched over. The LED flashes when the preamplifier is switched on.

3.2.3.5 Automatic Setting of Attenuation (Autorange Operation)

With automatic operation the receiver sets RF attenuation and operating mode (MODE) such that the level applied to the RF input is always within the valid operating range. After switching on of the receiver 10 dB of RF attenuation at least are always switched on. This serves to protect the input mixer and preamplifier against levels inadvertently applied too high. 0 dB of RF attenuation is only used in automatic operation, if it was switched on once before switching to automatic operation. The following criteria are of importance for setting optimal attenuation:

- the overload indications at the positions critical in the receiving path,
- the peak value at the output of the envelope demodulator and
- the measured value in the set indicating mode (DETECTOR).

Settings in keeping with these criteria make sure that levels measured in autorange operation are valid in any case and not invalidated by overloading in a receiver stage.

Hysteresis for changing over attenuation at the lower end of the operating range prevents continuous switching on and off of attenuation due to varying input levels .

Operation:

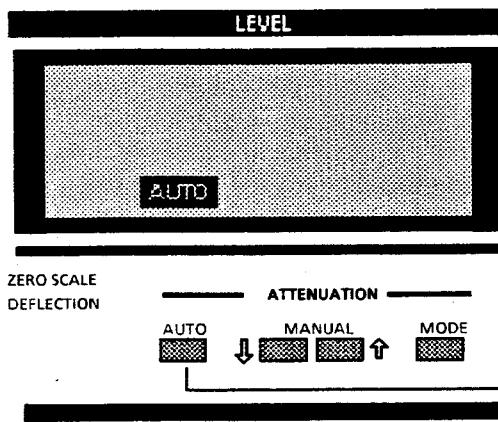

Switch for automatic operation.
Automatic operation is indicated by inverse display of the word AUTO in the LEVEL display.

Automatic operation can be switched off by

- pressing the AUTO key or
- manual switching of attenuator

3.2.3.6 Selecting the Operating Range (OPERATING RANGE)

The ESVD offers the operating ranges 30 dB and 60 dB. In both ranges the analog indication is dB-linear, i.e. the indication voltage is indicated logarithmically.

The 30-dB range offers the advantage of a higher resolution on the analog instrument.

Recording of strongly varying signals without attenuation switch-over is facilitated in the 60-dB operating range. The step size of the level switch in automatic operation is thus larger than in the 30-dB range. The relation between step size of attenuation and operating range is shown in the following table:

Table 3-2

Operating Range	Attenuation Step
30 dB	10 dB
60 dB	30 dB

In the 60-dB range measuring speed during a frequency scan is higher, if there is a strongly varying spectrum and therefore the attenuator need not be switched over so often as in the 30-dB range. In addition signal-to-noise ratio is increased in the upper half of the operating range.

Note: Although the nominal operating ranges are specified only with 30 or 60 dB, it is possible to measure to the noise limit with only slightly reduced accuracy at ambient temperatures of between + 15° C and + 30° C. This means that, e.g in the 60-dB range, indication is linear up to 10 dB below the beginning of the range (= 70-dB range).

Operation:

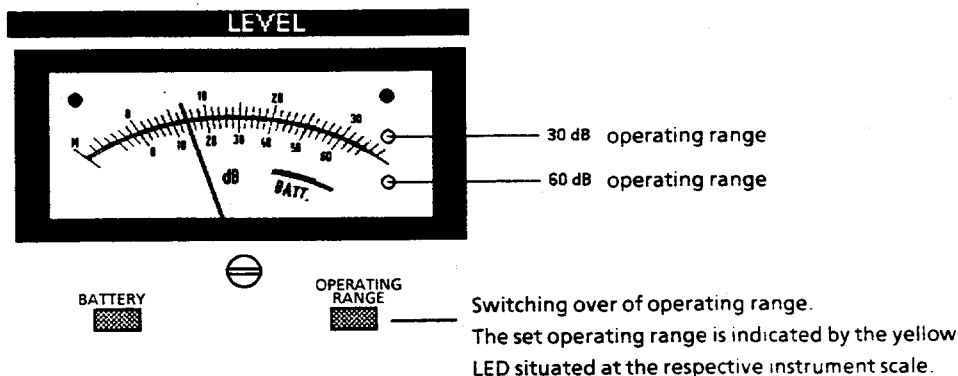

3.2.3.7 Level Indication

The measured level is displayed both by the analog meter (2) and digitally in the display LEVEL (4).

3.2.3.7.1 Digital Level Indication

Compared to analog indication, digital level indication has the advantage of being more accurate since the correction values for the linearity of the rectifier and that of the logarithmic amplifier which are both determined during total calibration are part of the value displayed. Resolution of the digital display is 0.1 dB in a range of -200 to +200 dB. If indication exceeds the value 200 due to the theoretically possible selection of a transducer of up to ± 200 dB, the level is output with a resolution of 1 dB on the LEVEL display. The unit of the measured quantity is also indicated. The basic unit of the indication is dB μ V. Other units can be selected by coding the connector ANTENNA CODE (cf. section 3.2.5.1), entering a transducer factor (cf. section 3.2.4.2.2) or by way of special functions (cf. section 3.3.2.3.13). The following units are possible:

Table 3-3

dB μ V	Voltage applied to 50 Ω at RF input of receiver
dB μ A	For current measurement, settable by coding connector ANTENNA CODE or by the unit of the transducer factor.
dB μ V/m	Electrical fieldstrength, settable by coding connector ANTENNA CODE or by the unit of the transducer factor.
dB μ A/m	Magnetic fieldstrength, settable by the unit of the transducer factor.
dB μ V/MHz	Spectral pulse voltage density, switched on in indicating mode Pk/MHz.
dB μ A/MHz	Spectral pulse current density, settable by coding connector ANTENNA CODE or by the unit of the transducer factor in indicating mode Pk/MHz
dB μ V/m/MHz	Spectral pulse density of the electrical fieldstrength, settable by coding connector ANTENNA CODE or by the unit of the transducer factor in indicating mode Pk/MHz
dB μ A/m/MHz	Spectral pulse density of the magnetic field strength, settable by the unit of the transducer factor in indicating mode Pk/MHz
dBpW	Power in dB relating to 1 picowatt, settable by the unit of the transducer factor
dBm	Power in dB relating to 1 milliwatt, settable by way of special function 20

3.2.3.7.2 Analog Level Indication

The level of analog indication is the result of adding the value for ZERO SCALE DEFLECTION in display LEVEL to that of the meter display in the selected operating range.

Zero scale deflection is indicated in 10 dB steps so that the addition can be performed without using any further means.

Example:

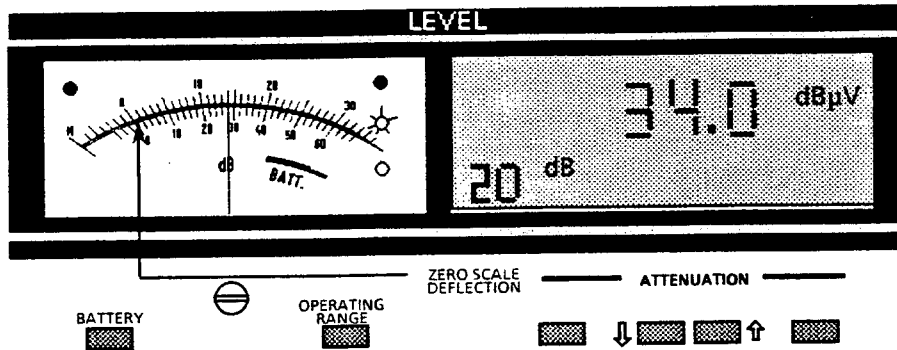

Meßwert: 14 dB + 20 dB = 34 dBµV

The unit of the digital measured value is also valid for indication on the analog meter.

Non-decadic transducer factors or the pseudo unit dBm, too are correctly taken into account with analog indication. In this case the complete tens digit is added to zero scale deflection whereas the one digit and the digit after the comma are added internally to the instrument voltage by way of a digital/analog converter. The operating range of the instrument is thus usually shifted, either to higher or to lower values (max. 6 dB). For this purpose, the 30- and 60-dB scale is extended by 6 dB at the upper and lower end of the scale respectively. To ensure that the user detects exceedings of the operating range (higher or lower), a red LED flashes at the upper or lower end of the scale.

3.2.3.7.3 Overload of Receiver

Although analog level indication is within the valid range, the receiver may be overloaded. This is, e.g. the case when a relatively weak signal is within the measuring bandwidth, however a strong signal is present outside the range. This strong signal may overload the stages before the IF filter. For this reason in the ESVD, the level is monitored at this critical positions. If a stage in the signal path is overloaded, the user will be informed about this by the message OVERLOAD on the LEVEL display.

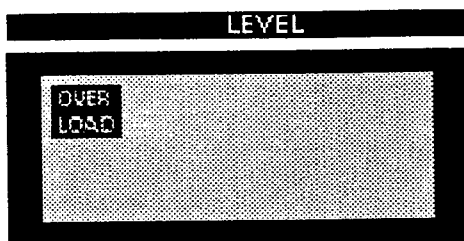

To guarantee correct measurement RF attenuation must be switched on additionally until OVERLOAD display disappears. In autorange operation, attenuation is automatically set such that no overload occurs.

3.2.3.8 Selecting IF Bandwidth (IF BW)

Selection of IF bandwidth depends on the bandwidth of the signal to be received and the required adjacent channel suppression. If great demands on sensitivity are made and with unmodulated signals and signals with narrow modulation bandwidth (AM broadcasting or narrowband FM), the 10-kHz bandwidth is preferably used. The 120-kHz bandwidth is however recommended for measurements of broadband signals, such as pulse signals or FM broadcasting signals.

The 120-kHz bandwidth meets the tolerance for the bandwidth of bands C and D (30 1000 MHz) specified in CISPR 16 and VDE 0876, respectively.

The 300-kHz bandwidth is provided for measurements of digitally-modulated signals as they occur for example in the GSM-cellular radio network. This bandwidth covers the complete GMSK-modulated spectrum.

For measurements on TV signals, broadband impulse disturbances and measurements according to the MIL standards use of the 1-MHz bandwidth is recommended. Highest sensitivity in the indicating mode Pk/MHz can be obtained with this bandwidth.

All the filters feature very low group delay distortion and are thus suitable for average measurement of pulse signals in accordance with CISPR 16. In the indicating mode quasi-peak (QP) the bandwidth is firmly linked to the receiver frequency, i.e. the 120-kHz bandwidth is always switched on.

Effective selectivity of the filters is shown in the following figure:

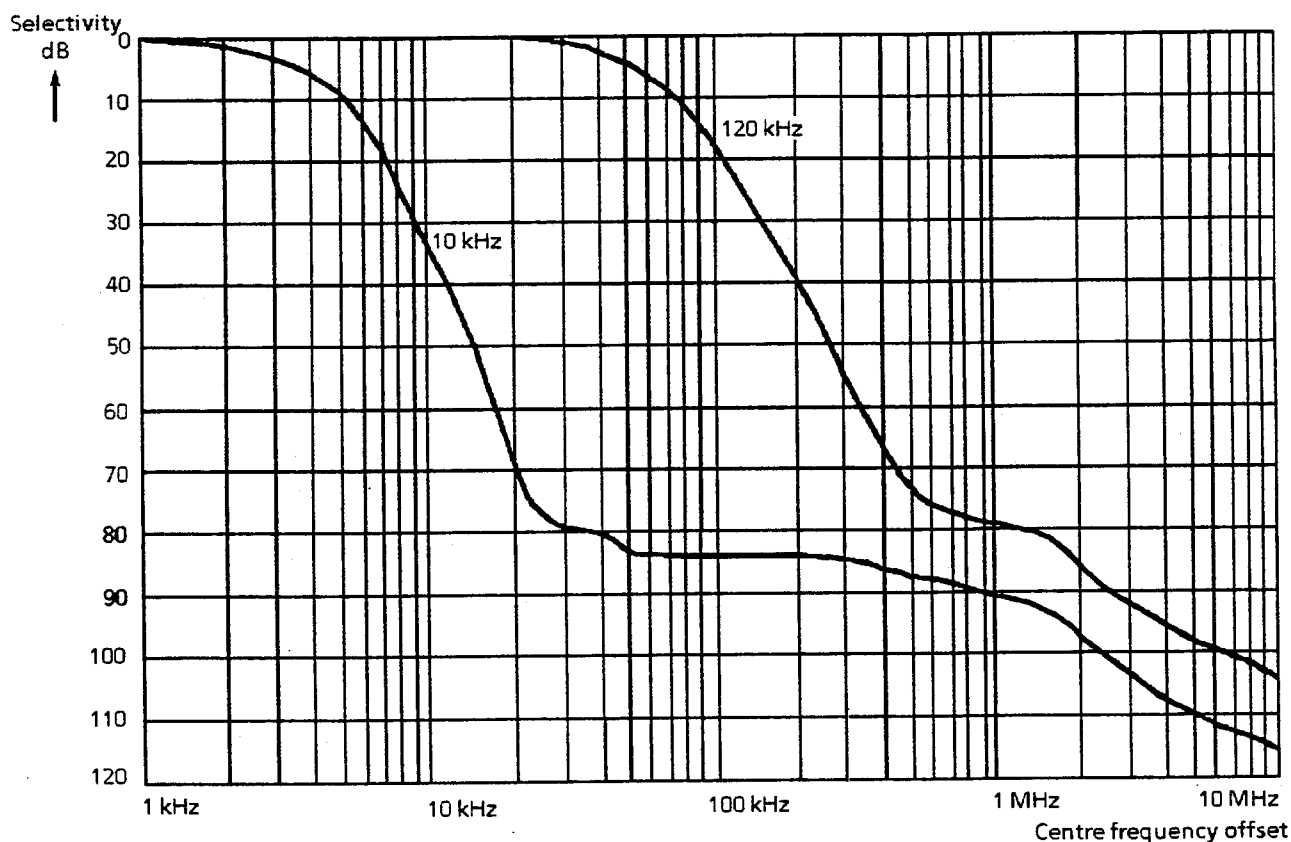
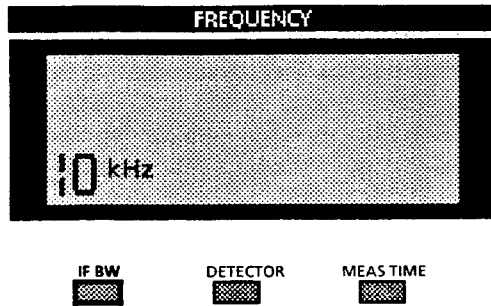

Fig. 3-4 Dynamic IF selectivity

Operation:



- ▶ Press IF BW key.
IF bandwidth is switched over (1 MHz → 300 kHz → 120 kHz → 10 kHz → 1 MHz...) and the newly set IF bandwidth is underlined to indicate that a new entry is possible using the numeric keypad DATA.
- ▶ Press ENTER key.
The bar disappears again (input of bandwidth is inactive).

3.2.3.9 Selecting the Weighting Mode (DETECTOR)

The indicating mode specifies how to weight the envelope of the IF signal. The weighting modes (detectors) average value (AV), peak value (Pk), peak value relating to 1 MHz bandwidth (Pk/MHz) and quasipeak value (QP) can be switched on in the ESVD. The consequences brought about by the selection of indicating mode is explained in the following paragraphs.

3.2.3.9.1 Average Measurement (AV)

In the case of average measurement the linear time-averaged value of the rectified voltage at the output of the envelope demodulator is indicated. It is calibrated using the RMS value of an unmodulated sinusoidal signal. If an unmodulated sinusoidal signal is applied to the receiver input, its RMS value is thus indicated; if an AM signal is present, the RMS value of the carrier is indicated.

With the ESVD, averaging is performed analog using lowpass filters, the time constants of which are switched over depending on the measuring time (cf. section 3.2.3.10). Weighting of pulses is described in sections 3.2.3.9.5 and 3.2.3.10.

3.2.3.9.2 Peak Value (Pk)

In the case of peak value measurement, the maximum value of the rectified voltage at the output of the envelope demodulator within the selected measuring time is indicated. It is calibrated using the RMS value of an unmodulated sinusoidal signal that supplies the same detection voltage. Average and peak value of an unmodulated sinusoidal signal result basically in the same indication. As, however, with peak value weighting, the noise voltage indication is about 11 dB higher than with average weighting, higher values are indicated when the signal-to-noise ratio is not sufficient (refer also to section 3.2.3.12.4, measuring accuracy).

Peak value indication serves for determining the levels of keyed carriers or pulse signals or peak voltages of AM signals. As peak value measurement can be carried out considerably faster than quasipeak measurement, with RFI measurements it is recommended to first perform a general measurement in indicating mode Pk and then a quasipeak measurement at the critical frequencies.

3.2.3.9.3 Measurement of Broadband Interferences (Pk/MHz)

In indicating mode Pk/MHz the spectral pulse voltage density of the input signal is measured. The peak value present at the output of the envelope demodulator within the selected measuring time is related to 1 MHz bandwidth while it is assumed that pulse-shaped signals are applied to the receiver input. The pulse voltage at the output of the IF filter is directly proportional to the pulse bandwidth (\approx 6dB bandwidth) of the filter, provided that the pulse frequency is low enough so that the individual pulses at the output of the filter do not overlap. In indicating mode Pk/MHz the peak value is thus increased arithmetically by the bandwidth factor

$$20 \times \log \frac{1 \text{ MHz}}{B_{IF}}$$

In the case of an IF bandwidth of 10 kHz (nominal value, actual value of 6-dB bandwidth: 9.5 kHz) this factor amounts to 40.4 dB, with an IF bandwidth of 120 kHz it is 18.4 dB and with an IF bandwidth of 300 kHz the factor is 8 dB.

Pulses with repetition frequencies of under 2 kHz provide the same result with all the bandwidths. In practice there are, however, usually mixtures of various pulse interferences the individual components of which are uncorrelated. In this case the values indicated are therefore considerably higher with the smaller bandwidths. The extreme case is white noise, be it thermal noise of the receiver or other similar spurious signals. In this case indication is increased proportionally to the reciprocal value of the root of bandwidth ratio, i.e.

$$\text{increase} = 20 \log \cdot \sqrt{\left(\frac{B_{IF}}{1 \text{ MHz}}\right)} = 10 \log \cdot \left(\frac{B_{IF}}{1 \text{ MHz}}\right)$$

The following table shows the increase in indication of thermal noise as a function of the IF bandwidth:

Table 3-4

IF bandwidth		Increase in display of thermal noise
Nominal bandwidth	6-dB bandwidth	
1 MHz	1 MHz	—
300 kHz	300 kHz	4 dB
120 kHz	120 kHz	9.2 dB
10 kHz	9.5 kHz	20.2 dB

The 1-MHz bandwidth is therefore preferably used as the measurement result comes closest to the amount of interference.

Narrow-band signals (sinusoidal signals) in the interference spectrum are most likely to be discovered by switching over to average value indication.

This fact is also illustrated in figure 3-5, section 3.2.3.9.5, which shows weighting of pulses by way of different indicating modes.

3.2.3.9.4 Quasipeak (QP)

Quasipeak measurement weights pulse signals using a quasipeak detector with defined charge and discharge time. IF bandwidth and mechanical time constant of the meter are also specified. The characteristics the receiver has in this indication mode are defined in CISPR 16 or in VDE 0876. The most important parameters are listed in the following table:

Table 3-4

	CISPR Band C/D
Frequency range	30 ... 1000 MHz
IF bandwidth	120 kHz
Charge time of QP-detector	1 ms
Discharge time of QP-detector	550 ms
Time constant of meter	100 ms

The meter time constant of ESVD is simulated electrically, so that it is also effective with digital indication. The instrument, itself, operates much quicker so that its own time constant does not affect the measurement result.

Due to the long time constants of weighting, it takes relatively long until a valid measurement result is displayed after every change in frequency or attenuation at the receiver. It is therefore futile to use measuring times of less than 1 s, especially in the case of automatic measurements.

The maximum value of level during the measuring time set is shown by the digital level display. The time varying quasi-peak test voltage can be observed at the analog meter. This often allows - apart from listening in to the interference source - to draw useful conclusions as to the character of the interference.

Although quasipeak weighting makes high demands on the dynamic characteristics of the receiver, with the ESVD the operating range can be selected without any restrictions. With low pulse frequencies the 60-dB range, however, cannot be made full use of as otherwise RF input would be overloaded. When overload occurs the user is informed about it by way of the overload indication (OVERLOAD) in the LEVEL display. The user should increase RF attenuation to such an extent that the overload message disappears. In automatic operation the receiver, itself, sets attenuation correctly.

3.2.3.9.5 Pulse Weighting in Various Weighting Modes

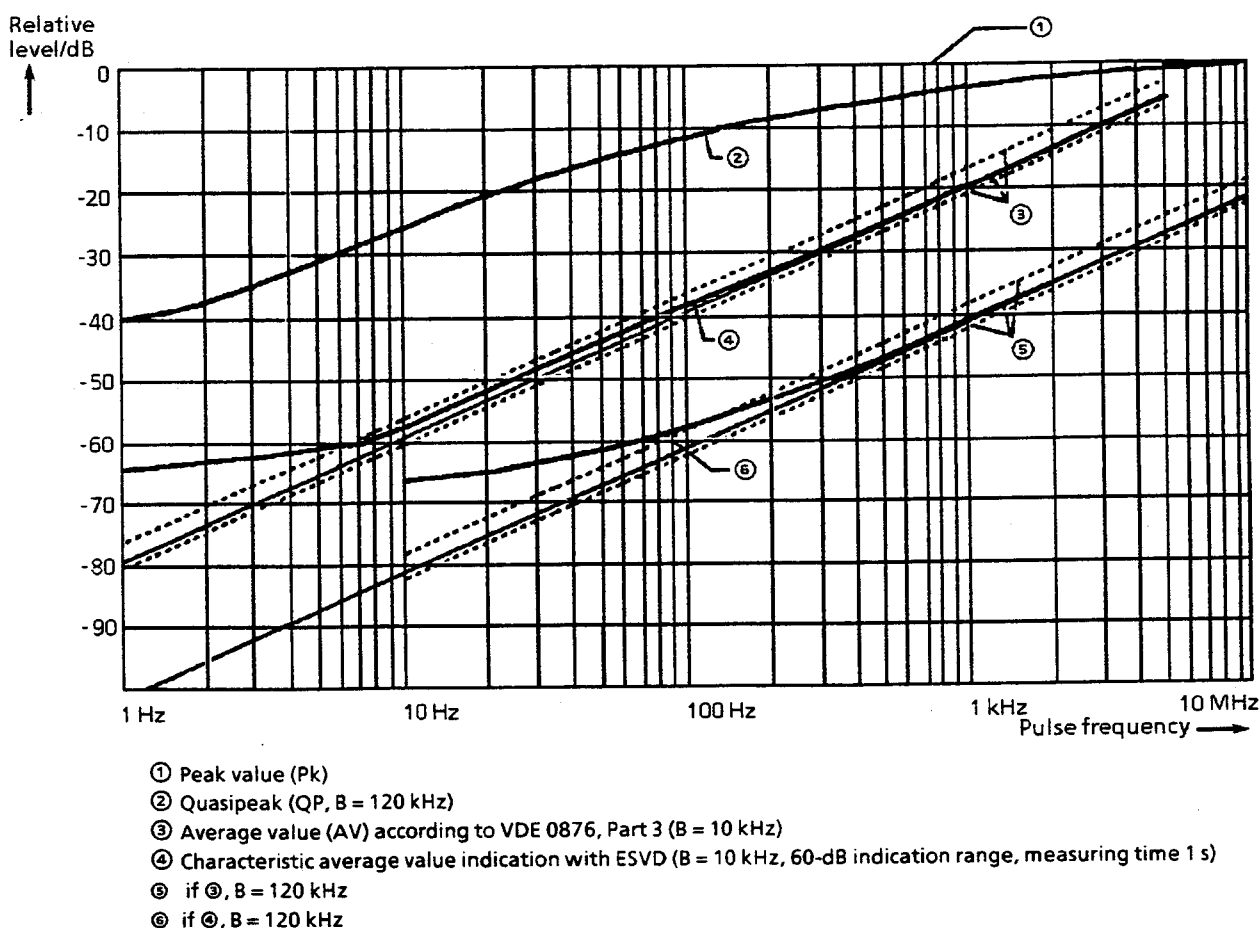
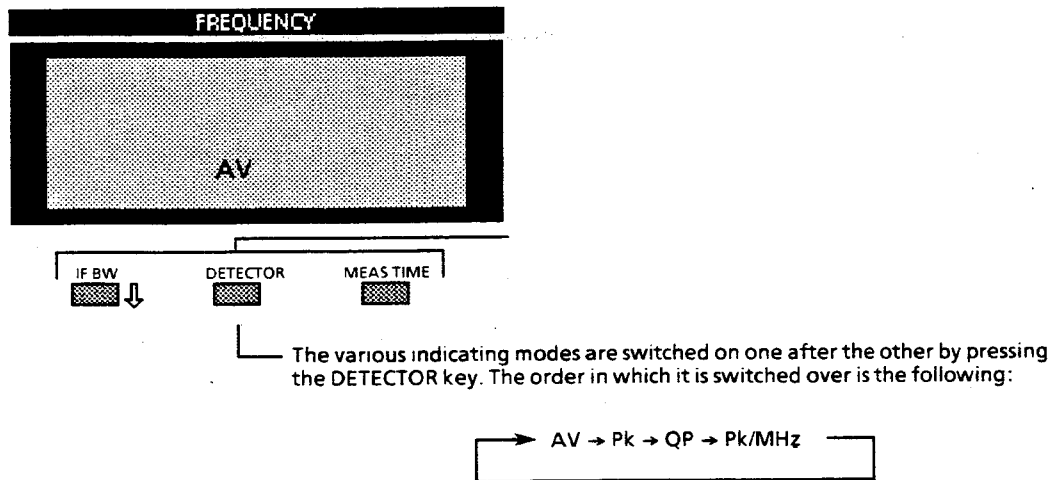

Fig. 3-5 Differences in weighting of pulses between the indicating modes AV, Pk and QP with IF bandwidths of 10 kHz and 120 kHz.

- Sinusoidal signals and pulses with a high repetition frequency result in the same indication in all three weighting modes.
- Peak value indication (Pk) always shows the peak value of the highest pulse independently of the number of pulses during measuring time.

- In quasi-peak mode (QP) level indication drops with decreasing pulse repetition frequency due to time constants specified in CISPR 16.
- Average value indication (AV) weights pulses proportionally to pulse frequency. Level indication decreases most rapidly (20 dB per decade) when pulse frequency is reduced. With the ESVD, the characteristic curve of average value indication (curve ④ and ⑤) is about 1 dB above the theoretical curve, however always within the error limits of +3 and -1 dB, which are agreed upon in VDE 0876 Part 3. The reason is a slight overshoot of the IF filters. Increase in indication for pulse repetition frequencies below 10 Hz is caused by internal receiver noise.

Operation:



3.2.3.10 Selecting the Measuring Time (MEAS TIME)

The measuring time is the time during which the input signal is monitored. The time that is required by the selected detector to settle following a change of attenuation or frequency is not part of it. The measuring time can be chosen within the range of 1 ms to 100 s in the steps 1, 2, 5, 10.

Significance with Peak Measurement:

In indicating mode Pk the maximum value of the level during measuring time is shown. At the beginning of measurement the peak detector is discharged. When the measuring time has elapsed, the output voltage of the detector is A/D-converted and then indicated. With measuring times of over 100 ms the peak voltage is A/D-converted every 100 ms and the maximum value of the individual measurements is taken as measurement value. Unmodulated signals can be measured using the shortest measuring time possible. In the case of pulse signals, measuring time must be set such that at least one pulse occurs during measuring time.

Significance with Average Measurement:

Averaging in indicating mode AV is performed using analog low-pass filters at the output of the linear envelope detector before the logarithmic amplifier. Following a change in frequency or attenuation the receiver therefore waits until the lowpass has settled and then measuring time begins. To keep waiting time as short as possible the receiver monitors the output signal during settling time. If it has already stabilized prior to the end of maximum waiting time, measurement is started earlier. If measurement times of more than 100 ms are selected, the linear output signal of the average value low-pass is also digitally averaged. (linear averaging)

Which measuring time to select depends on the IF bandwidth set and the character of the signal to be measured.

Unmodulated sinusoidal signals and signals with correspondingly high modulation frequencies can be measured using short times. Slowly varying signals or pulse signals require longer measuring times. The following table indicates up to which repetition frequencies pulses as a function of measuring time are still measured correctly (add. error of level indication < 1 dB).

Table 3-5

Measuring time	Min. pulse frequency for correct measurements
1 ms to 20 ms	1 kHz
50 ms to 200 ms	100 Hz
≥ 0.5 s	10 Hz

Thus the shortest measuring time (1 ms) can be used for RFI voltage measurements due to the following reasons: The difference between the limit values for quasipeak and those for average value in the case of RFI voltage measurements amounts to maximally 13 dB (CISPR, publ. 22, instruments of class A). According to figure 3-5 showing the weighting curves this difference occurs at a pulse frequency of 1.8 kHz.

The decisive value for lower pulse frequencies is always the quasipeak limit value. This means that average value indication has to be correct only up to this pulse frequency. As pulses with repetition frequencies of down to 1 kHz can be averaged correctly using a measuring time of 1 ms, it can be applied without reservation for this type of measurement.

Significance with Quasi-peak Measurement:

The relatively long time constants occurring with quasipeak weighting result inevitably in relatively long measuring times that must be set in order to obtain a correct test result. In any case it should amount to not less than 1 second, if the signals to be measured are unknown. A measuring time of that length ensures that pulses with a repetition rate of down to about 5 Hz are correctly weighted.

When switching over attenuation or changing frequency the receiver waits until the measurement voltage has settled and then starts measuring. To reduce waiting time it is monitored whether the signal at the output of the weighting circuit has already stabilized before maximum waiting time has elapsed. If this is the case, measurement is started earlier.

Operation:

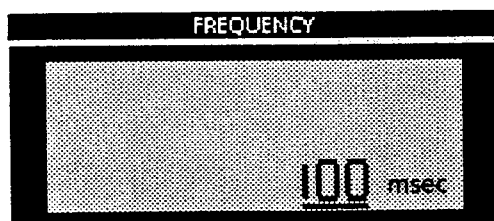

- ▶ Press MEAS TIME key.
To indicate that the measuring time input is active, a bar appears below the display for measuring time.
- ▶ Enter a new measuring time using numeric keypad DATA (cf. section 3.2.2).
- ▶ End input by the desired unit.
The new measuring time is displayed together with the unit.

Note: *Measuring times below 200 ms must be entered in milliseconds; from 200 ms onward seconds must be input as graphical representation is limited to 2^{1/2} positions.*

3.2.3.11 Selecting AF Demodulation (DEMODO)

The ESVD offers the demodulation modes F3, A3 and A0.

The demodulation mode F3 is selected for demodulating FM signals. Bandwidth and slope of the demodulator are adapted to the selected IF bandwidth in order to achieve an optimum AF signal/noise ratio. Narrowband FM signals are best demodulated with an IF bandwidth of 10 kHz, whereas FM broadcasting signals are best demodulated with an IF bandwidth of 120 kHz. The AF bandwidth is 5 kHz for an IF bandwidth of 10 kHz and it is 30 kHz for all other IF bandwidths.

A3 stands for demodulation of AM broadcasting signals. AF bandwidth is limited to 5 kHz. In the indicating mode quasi-peak (QP), noise in the AF branch is suppressed to some extent in order to show more clearly the devices interfering with pulses. Distortion of signals to which sine-wave modulation has been applied is however higher due to this measure than in other indicating modes.

In the case of A0 a carrier with the frequency of the IF is mixed to the signal on its last IF. If it is an unmodulated signal that is tuned to the receiver centre frequency, zero beat (no audible tone) is the result. When the receiver is detuned, a tone can be heard the frequency of which corresponds to the difference between input signal and receiver frequency. This is helpful when a sinusoidal signal must be discovered in a signal mixture or when the receiver should be tuned exactly to a signal.

Both the volume of the internal loudspeaker and that of the headphones connected to AF OUTPUT socket is set using the rotary knob (15). The loudspeaker is automatically switched off when a PL-55 connector is plugged into the AF OUTPUT socket (e.g. with headphones operation).

Note: When the beeper is activated (cf. section 3.2.3.13), AF demodulation must be switched on, as otherwise the beeper is not audible. Nevertheless volume control knob may be at the left stop so that the demodulated AF cannot be heard.

Operation:

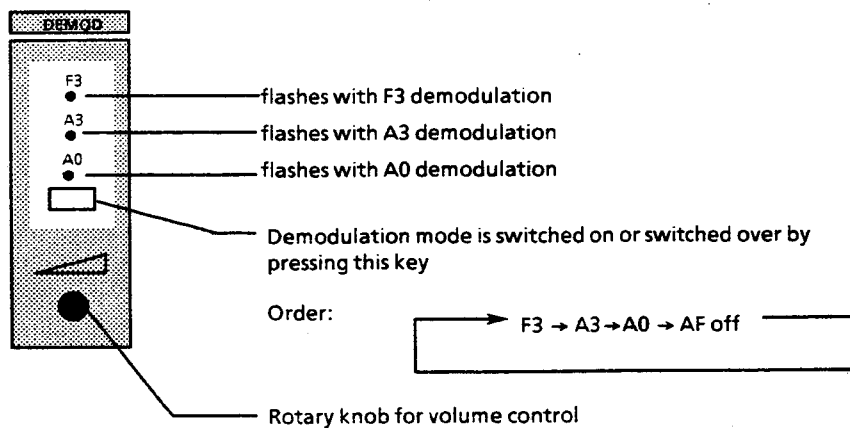

3.2.3.12 Calibration and Measurement Accuracy

The ESVD is calibrated using an internal sinewave generator and an harmonics generator that generates a 100-kHz spectrum that is flat from 20 to 2050 MHz. It is possible to perform both short calibration on the receiving frequency and total calibration, during which the entire receiver is calibrated using a complex process.

3.2.3.12.1 Short Calibration

During short calibration the gain of the receiver at the reference frequency of 64 MHz with and without preamplifier and at the IF bandwidths is adjusted. The gain determined is maintained until the next calibration is performed. In addition the gain is corrected at the 100-kHz spectral line that is closest to the current receiving frequency. This correction is no longer effective when the receiver frequency is changed.

In case total gain of the ESVD has to be corrected by more than 1 dB, the message "CAL TOTAL required" is read out in the DATA INPUT display. To fully restore the measurement accuracy, perform a total calibration.

3.2.3.12.2 Total Calibration

When performing a total calibration the following parameters are recorded and saved in a non-volatile memory:

- frequency response with and without preamplifier,
- correction values for the IF bandwidths (gain and bandwidth for Pk/MHz),
- correction values for IF gain (low noise and low distortion),
- correction values for quasi-peak weighting and
- linearity correction values for the 30-and 60-dB ranges.

Total calibration takes about 60 seconds. It eliminates the need for a calibration of the receiver after having switched over a receiver setting. Thus optimal measurement speed is possible while high measurement accuracy is ensured. It is recommended to carry out total calibration about 30 minutes after the instrument has warmed up. Due to high stability of the receiver the correction values remain constant for a long time and therefore need not be set anew daily.

Operation:

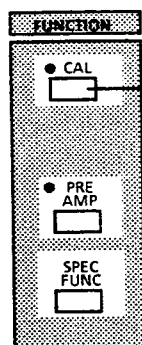

When shortly pressing the CAL key (< 3 s) short calibration is started. The LED flashes during calibration process and the remark *CAL SHORT* appears in the DATA INPUT display.

When pressing the key for a longer time (> 3 s) total calibration is started. The LED flashes during calibration process and the information *CAL TOTAL* appears in the DATA INPUT display (1) during calibration.

Following completion of calibration, the message *CAL COMPLETE* appears in the DATA INPUT display.

3.2.3.12.3 Error Messages during Calibration

During total and short calibration all correction values recorded are checked whether they are within the tolerances internally specified. If one of the tolerances is exceeded, a warning is output on the DATA INPUT display. The receiver can, however, be further used as it still meets the specifications with only slight reservations. If a function does not work correctly, error (*ERR*) is output and calibration is aborted. Error messages are automatically output on a printer connected during calibration. In addition the messages are presented to the user via IEC-bus (cf. section 3.3).

The following warnings and error messages are possible:

- CAL TOTAL required* If, with short calibration, gain deviates from the value determined during the last total calibration by more than 1 dB, the user is requested to carry out a total calibration.
- ERR: Gain at 64 MHz* Gain at the reference frequency 64 MHz cannot be controlled. Calibration is aborted.
- WARN: Gain at 64 MHz* Basic gain of the receiver is not within the internal tolerance limits at the reference frequency 64 MHz. Calibration continues. It is, however, possible that another receiver parameter can no longer be corrected. The user is informed about this occurrence by another error message.
- WARN: BW 10 kHz* Gain at the 10-kHz IF bandwidth is outside the tolerance limits. Calibration continues. It is, however, possible that another receiver parameter can no longer be corrected. The user is informed about this occurrence by another error message.
- ERR: BW 120 kHz*
BW 300kHz
BW 1 MHz Gain at 120-kHz IF bandwidth can no longer be corrected. It is not possible to carry out measurements using this bandwidth. Calibration is aborted.
- WARN: IF ATT* IF attenuation correction value is out of tolerance. The IF attenuation is set in 10-dB steps depending on the operating mode (MODE) and the indicating mode (DETECTOR). If one of these settings exceeds its internal tolerance limits, correction of total gain of the ESVD may not be possible anymore. A separate error message informs the user about this fault. Calibration continues.
- ERR: IF ATT* The IF gain switch is defective so that it is no longer possible to correct its gain error. Calibration is aborted.
- WARN: 30 dB Range*
WARN: 60 dB Range Linearity of the test detector is out of tolerance, which results in a slightly reduced total linearity as interpolation must make up for relatively great deviations between the interpolation points. Calibration continues.
- ERR: 30 dB Range;*
ERR: 60 dB Range The 30- or 60-dB operating range is defective and can no longer be used. Calibration is aborted.
- WARN: Pk/MHz* The correction value for the bandwidth in the indicating mode Pk/MHz is not within the tolerances. This means that the permissible tolerance for the IF bandwidth 10 or 120 kHz is not adhered to. Calibration continues.
- ERR: Pk/MHz* Pk/MHz indicating mode is defective. Calibration is aborted.
- WARN: QP* Quasi-peak weighting is out of tolerance at the reference pulse frequency (100 Hz). Calibration continues.
- ERR: QP* Quasi-peak weighting is defective. Calibration is aborted.

WARN: Gain at xx MHz/(kHz) When recording frequency response of the receiver it is noted that the internal tolerance is exceeded. This may have the result that the total correction value may be too high and cannot be set anymore. Calibration continues.

ERR: Gain at xx MHz/(kHz) A filter range of the preselection is defective. Measurements in this range are not possible. Calibration is aborted.

Error Handling during Measurement:

In theory the sum of the individual correction values may exceed the maximum value, although none of the individual values exceeds the tolerances that would lead to an error message. If this is the case, the message *ERR: Meas uncal* is output on the DATA INPUT display. Illegal measurement values are also shown when output is effected via IEC-bus (cf. section 3.3).

3.2.3.12.4 Measurement Accuracy

When performing a total calibration, all the values determined are related to the internal calibration generator and RF attenuator. The linearity of the operating ranges is recorded in 10-dB steps. It is interpolated between the interpolation points. Due to the high linearity of the envelope detector and logarithmic amplifier (typ. error < 0.25 dB), the interpolation points are sufficient for an optimal correction. The measurement value is internally (by the instrument itself) determined in $1/100$ dB so that rounding errors are not of significance.

The error limits are composed of:

Error limits of attenuator:	0.4 dB
Error limits of calibration generator:	0.7 dB
Setting accuracy of gain:	0.05 dB
Nonlinearity of envelope detector:	0.2 dB

The individual errors do not depend statistically on each other, so that the total error is the result of quadratic addition. It amounts to 0.9 dB for the complete measurable level range. In practice the accuracy for signals with sufficiently high signal-to-noise ratio is considerably higher.

In the case of small test levels, indication is further increased by the internal receiver noise. This additional measurement error, which is determined by physics, is the least significant with average value indication; with peak value indication, however, it is considerably higher. In indicating mode quasi-peak the error strongly depends on the type of signal to be measured.

In the case of average and peak value the error as a result of the signal-to-noise ratio can be approximated by the following formulas:

$$\text{Average value:} = \text{error/dB} \approx 20 \log \left(1 + 0.3 \times \frac{N_1}{s} \right)$$

$$\text{Peak value:} = \text{error/dB} \approx 20 \log \left(1 + 0.8 \times \frac{N_2}{s} \right)$$

S = level of an unmodulated signal in μV ,

N_1 = Noise indication with average value (AV) in μV

N_2 = Noise indication with peak value (Pk) in μV

$N_2 \approx N_1 + 11 \text{ dB}$.

Table 3-7 and figure 3-6 illustrate increase in indication in the case of average value measurement of sinusoidal signals and peak value measurement as a function of the signal-to noise ratio.

Table 3-7: Error occurring when measuring an unmodulated sinusoidal signal with average or peak value indication as a function of the signal-to-noise ratio.

Signal-to-noise ratio	Increase in indication in dB with	
	Average value (AV)	Peak value (Pk)
0	2.28	5.10
1	1.86	4.67
2	1.50	4.27
3	1.21	3.98
4	0.98	3.54
5	0.79	3.22
6	0.63	2.92
7	0.50	2.65
8	0.40	2.39
9	0.32	2.16
10	0.26	1.95
12	0.16	1.59
14	0.10	1.28
16	0.06	1.03
18	0.04	0.83
20	0.02	0.67
25	0.01	0.38
30		0.22
40		0.07
50		0.02

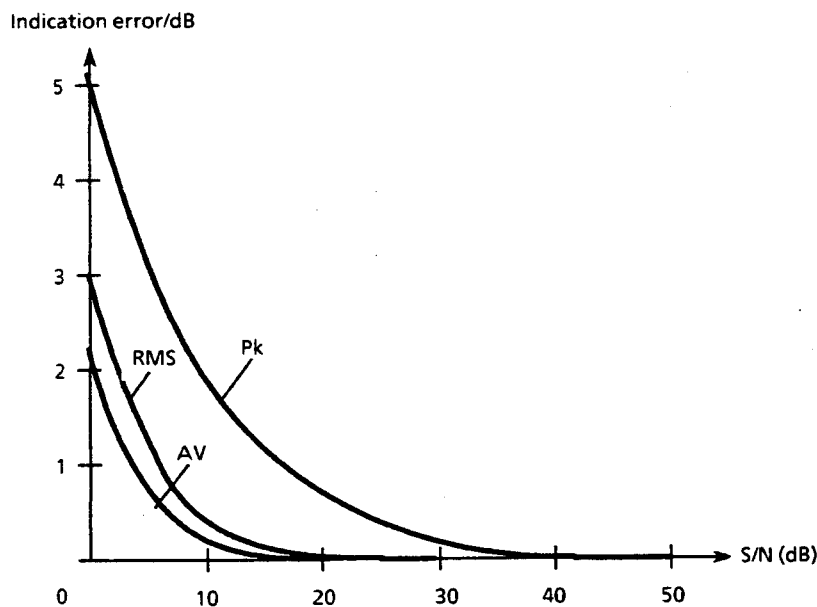
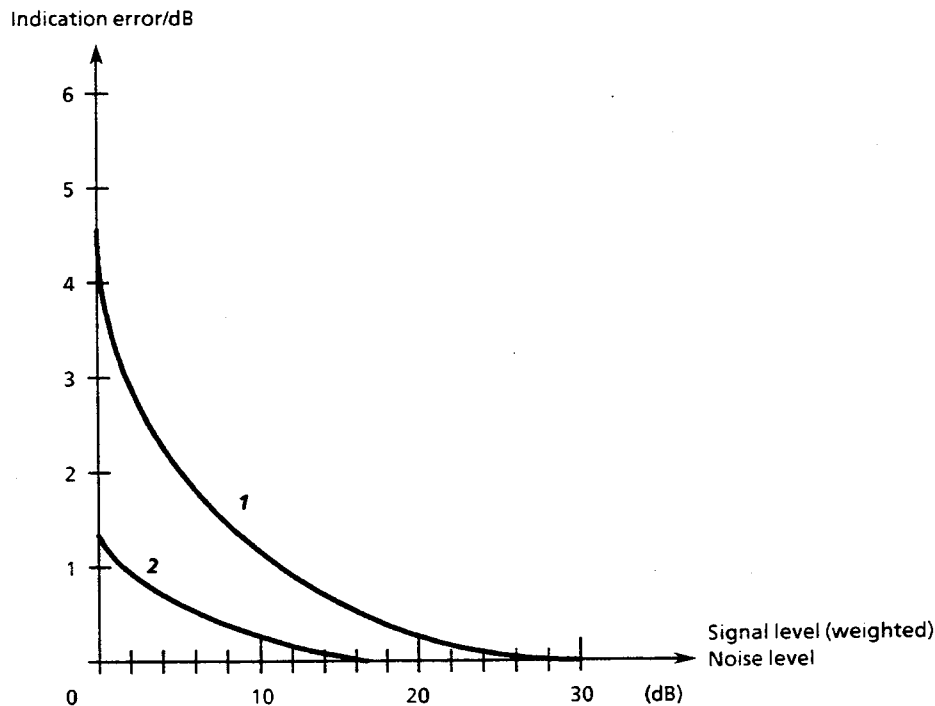

Fig. 3-6 Increase in indication of an unmodulated sinusoidal signal as a result of noise as a function of the signal-to-noise ratio.

Fig. 3-7 illustrates the increase in indication as a result of receiver-internal noise with quasi-peak indication for sinusoidal signals and pulse signals with a pulse repetition frequency of 100 Hz. Due to pulse weighting the error strongly depends on the type of input signal. In the case of sinusoidal signals the increase in indication is almost as high as with peak value indication. With pulses the indication error due to noise is reduced with decreasing pulse frequency.



- ① when measuring sinusoidal signals
- ② when measuring pulse signals with a pulse repetition frequency of 100 Hz

Fig. 3-7 Indication error due to noise with quasi-peak indication

For measurements carried out in practice the following can be recommended:

- To make full use of the accuracy of the ESVD, carry out measurements with a high signal-to-noise ratio, i.e. 60-dB range, low noise.
- When measuring sinusoidal signals use average value indication as it is the least sensitive to the signal-to-noise ratio.
- Carry out quasi-peak measurements using low noise, if the type of input signal permits this mode (cf. section 3.2.3.3, Selecting the Operating Mode). In autorange operation the receiver, itself takes it into account.

3.2.3.13 Special Functions (SPEC FUNC)

Special functions are integrated into the ESVD for applications requiring special properties of the receiver. The user, himself, can select - to a certain extent - the properties of the receiver using these special functions.

Each special function has a number and a name so that it can be easily addressed. To arrange them even more clearly they are divided into groups, each beginning with a new tens place.

Table 3-8

Special function groups	Call
Test parameters	SPEC FUNC 01
Switch functions	SPEC FUNC 10, 11, 12, 13, 16, 17
Output of measured values	SPEC FUNC 20,
Special measurement modes	SPEC FUNC 30, 31 32, 33,
Trigger functions	SPEC FUNC 51, 52, 53

Operation:

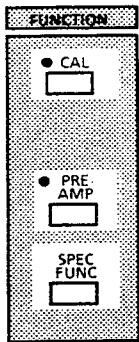

- ▶ Press SPEC FUNC key.
In the DATA INPUT display the SPECIAL FUNCTION menu appears:

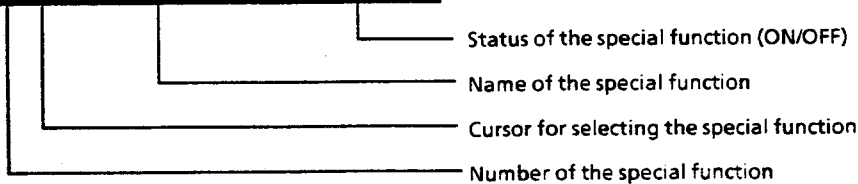
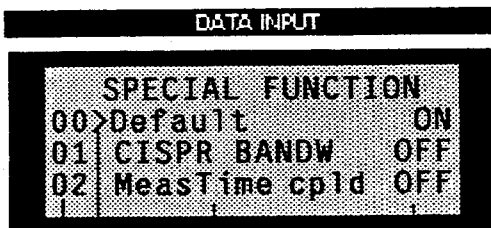

Each menu features three special functions. The cursor is positioned on the desired function using the ↑ and ↓ keys available in the EDIT keypad. The menu can be scrolled to have access to special functions that are not displayed at the moment.

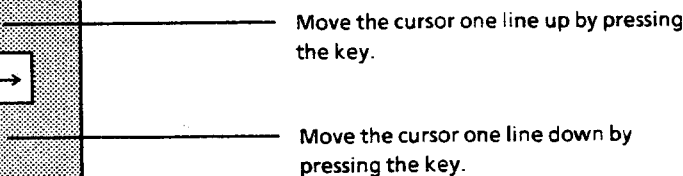
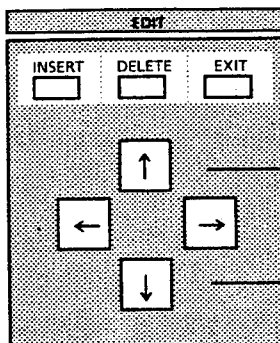

A special function can be selected more rapidly by entering the respective number. In this case the cursor moves directly to the desired special function.

The status of the special function is switched over (ON → OFF, OFF → ON) by pressing one of the ENTER keys. The cursor remains on the selected function after switch-over. This means that the special function is switched on or off by pressing the ENTER key.

The special functions 50 and 51 call submenus in which numeric data must be input. Following the entry of the respective data the SPECIAL FUNCTION menu with the modified status of the selected function is displayed again.

Explanations to the Various Special Functions:

- SPEC FUNC 00 Default* Any special function assumes its default setting using the special function *00 Default*.
- SPEC FUNC 01 CISPR BW* Default setting is OFF.
With *CISPR BW ON* the bandwidth specified for the indicating mode quasi-peak (120 kHz) are switched on not only in this mode but also in average and peak value indicating mode depending on the receiver frequency (cf. section 3.2.3.9.4).
- SPEC FUNC 10 Display Light* When operating with internal battery, default setting is OFF, otherwise ON.
To increase operating time when using internal battery, illumination of the LC displays is switched off. The receiver, itself recognizes by which source it is fed and switches lighting correspondingly. When operating under poor lighting conditions, it is however recommended to switch on illumination.
Power consumption of the LCD-illumination: about 5 W. This corresponds to approx. 12.5 % of the receiver power consumption.
- SPEC FUNC 11 IEC 625* When operating with internal battery, default setting is OFF, otherwise ON.
IEC-bus operation is usually not desired when operating with internal battery, as the required controller usually must be mains-operated. The IEC-bus is therefore switched off to increase operating time. The receiver, itself recognizes by which source it is fed and selects the status of the IEC-bus correspondingly.
Power consumption of module "IEC-BUS": about 1.2 W. This corresponds to approx. 8.5 % of the receiver power consumption.
- SPEC FUNC 12 Antenna Code* Default setting is ON.
Transducers from Rohde & Schwarz such as the VHF current probe ESV-Z1 or the broadband dipole HUF-Z1 provide a nearly constant conversion factor within their specified frequency range. This can be taken into account by fitting a coding connector to the ANTENNA CODE socket. If coding of the conversion factor is not desired because e.g. an additional test cable is used, it can be switched off using this special function. The individual conversion factor can then be input via the transducer factor (cf. section 3.2.4.2.2). Coding at the ANTENNA CODE socket is then always ineffective regardless of the setting of the special function.

SPEC FUNC 13 Beeper

Default setting is OFF.

The ESVD contains an internal beeper, which draws the attention of the user to various states of the instrument. In the following cases a beeping sound can be heard:

- end of a frequency scan,
- end of a plotting process,
- end of a printing process,
- Output of an error message or warning and
- following a faulty key input by the user.

It is however required that the AF is switched on. The loudness of the beeping sound is independent of the volume setting, i.e. if the demodulated AF signal is not desired, volume control can be turned completely down.

SPEC FUNC 16 Check Limit

Default setting is OFF.

This function is only effective in receiver mode (not in scan mode). When a limit line is active, each measured value is compared with the limit value provided that the special function is switched on. When the value is higher than the limit, the message *Limit exceeded* is output on the DATA INPUT display. If the value is below the limit value, the message disappears again. With the beeper being switched on (*Spec Func 13*), a beeping sound is audible when the limit value is exceeded during the first measurement on a new frequency.

If a double test mode is switched on in receiver mode (special functions 30 to 33), the message indicating that a limit value was exceeded appears when at least one of the two measurement values exceeds its associated limit value. Chapter 3.2.4.3.2 describes how to assign measurement detectors to limit values. In standards, limit values for peak or quasipeak are always higher than that for average.

SPEC FUNC 17 Check Transd

Default setting is OFF.

With special function 17 switched on, the transducer value (with unit) that has been calculated from the set receiver frequency is indicated instead of the measurement value on the LEVEL display. In this case, the level is not measured. In the LEVEL display there is no indication of ZERO SCALE DEFLECTION, ATTENUATION and MODE and in the FREQUENCY display bandwidth, detector and measuring time are not shown when outputting transducers. The activated transducer can thus be checked manually by detuning the receiver frequency. The transducer can also be output graphically on plotter or printer. The axes for level and frequency are determined by the values defined in the scan data set (cf. section 3.2.4.3.1). Output is initiated by pressing the PLOT or PRINT key (cf. section 3.2.4.4).

SPEC FUNC 18 Transducerswitch

Default setting is OFF. A port of the USER INTERFACE at the rear panel of the ESVD can be set using special function 18 in combination with an active transducer set. A single port (5-V logic level) is assigned to each transducer range. The number of the active port corresponds with that of the range valid for the current receiver frequency, i.e. port 1 (pin 14) is active in transducer range 1. There is no active port when the receiver frequency is outside the defined transducer set. This function is useful for switching different antennae by way of an antenna matrix during a scan or with manual frequency variation.

The message Change Transducer is suppressed when using special function 18.

Note the maximum current capacity when supplying an external switch by the device supply voltages of +5 V or +12 V. The peak current must not exceed 500 mA, the permanent current capacity being 200 mA. The control ports must not be loaded by more than 4 mA.

SPEC FUNC 20 Unit dBm

Default setting is OFF.

The unit dBm is used for the power level at 50 Ω . The ESVD is, however, not an r.m.s. value meter. The voltage indicated in the selected indicating mode together with the rated input resistance of 50 Ω are only converted into the respective power level. Solely the power of a signal that has not been amplitude-modulated is correctly indicated.

As the unit can only be used for power levels related to 1 mW, the special function is only effective when no unit is coded at the ANTENNA CODE socket. The unit is also only active with transducer factors having the unit dB, i.e. only four-terminal networks with specified power attenuation or power gain can be taken into account.

When coding a unit at the ANTENNA CODE socket or entering a unit other than dB in the transducer factor, the unit dBm becomes ineffective and the selected unit is displayed.

SPEC FUNC 30: Pk + AV

SPEC FUNC 31: Pk + Pk/MHz

SPEC FUNC 32: Pk + QP

SPEC FUNC 33: QP + AV

Default setting is OFF.

The special functions 30 to 33 serve to perform a measurement simultaneously with two different detectors. Both detectors selected are displayed in the detector display. However, only the detector stated first is indicated in the level display. In IEC bus mode both measured values are output to the process controller. Thus it is for example possible to detect broadband interference using the peak value detector and narrow-band interference by means of the average value detector at the same time. In the case of an automatic frequency scan only one scan is required. Both values are saved for plotter or printer output, however only the first value is displayed (example: Pk + AV \rightarrow Pk is indicated). When outputting the test curve on a plotter during the scan (option Meas.& Plot, cf. section 3.2.4.3.3) the curve for the first indicating mode is immediately displayed, the second test curve is displayed subsequently (example: Pk + AV \rightarrow the Pk-curve is plotted during measurement and later the AV-curve). Only one of the double measurement modes can be active at one time. When switching on a new function, the one that has already been activated is automatically switched off.

SPEC FUNC 51: ExtTrigger +

Default setting is OFF.

The ESVD starts a measurement with a positive signal edge (TTL level) at the USER INTERFACE (item 28, fig. 3-2), connector pin assignment, cf. section 3.2.6.5. This is useful, if for example a test item produces interference at a certain time and a suitable trigger pulse can be derived from the test item. It makes sense to set optimum attenuation of the ESVD prior to the measurement, if there is not enough time for autoranging.

SPEC FUNC 52: ExtTrigger -

Default setting is OFF.

The ESVD starts a measurement with a negative signal edge (TTL level) present at the USER INTERFACE (28), connector pin assignment cf. section 3.2.6.5. It is useful to set optimally the attenuation of the ESVD prior to the measurement, if the time for autoranging is not sufficient. The special function is automatically deactivated when the special functions SPEC FUNC 51 are switched on.

SPEC FUNC 53: Fast Level -

Default setting is OFF.

This special function is especially provided for recording fieldstrength patterns in mobile use. A very fast level measurement (up to 5000 measured values per second) can be performed via IEC bus using the special function externally triggered by e.g. a position transducer. The function can only be operated via IEC bus and is not displayed in the menu for the special functions.

For reasons of speed, measurement and measured value output are interleaved to such an extent that during the current measurement the level of the previous measurement is output to the process controller. Triggered by an edge at the input for the external trigger (positive or negative, selectable by special functions 51 and 52), a new measurement is started. The result of the last measurement is output during the sampling time for the next measurement. To achieve the maximum measurement rate, the process controller must be able to accept the measured value within the set sampling time.

The complete cycle time for a measurement is determined by the sampling time and a time required for internal processes provided that the process controller fulfills the condition stated above. The internal processes take max. 200 μ s with automatic attenuation setting (AUTO) selected and max. 100 μ s without automatic attenuation setting, respectively. Measurement rates of 3000 or 5000 measurements per second can thus be achieved with a sampling time of 100 μ s. The programmable sampling time t_{sample} allows to match the ESVD to the measurement rate required for the respective application. It can be set between 100 μ s and 32 ms by the process controller, which must also ensure that the minimum required time is adhered to.

The level is not displayed as it would take too much time.

Use of the special function modifies autorange operation. During the short time available the calibrated RF attenuator cannot be switched. Therefore IF attenuation only (0 to 40 dB) is switched. The criterion for switching is always the value measured last. If the difference between this value and the upper or lower limit of the indication range is less than 10 dB, IF attenuation is increased or decreased by 10 dB respectively during the new measurement. With e.g. an IF bandwidth of 300 kHz a dynamic range of more than 90 dB can thus be achieved.

Usage of the special functions and measured value output via IEC bus are referred to in section 3.3.10. Measurements on several frequencies using special function 53 is dealt with in section 3.2.4.3.3, "Extended functions of RF analysis (OPTIONS)".

3.2.4 Operation of the Menu Functions

The hardkeys of the keypad MENU are provided for presetting instrument parameters, controlling complex processes, entering limit lines and transducer factors, outputting measurement results and calling instrument self-tests. The keys can be used for calling a menu in the display DATA INPUT, which makes various submenus accessible, if required.

3.2.4.1 Input and Editing in the DATA INPUT Display

3.2.4.1.1 Editing the Menus

The display DATA INPUT is an alphanumeric LC-display with 4 lines featuring 20 characters each. The first line contains the designation of the menu currently active. The remaining three lines consist of the individual menu points. In some menus there is not enough space to display the list of selectable menu points. Every menu point becomes visible by scrolling the list upward or downward using the respective cursors.

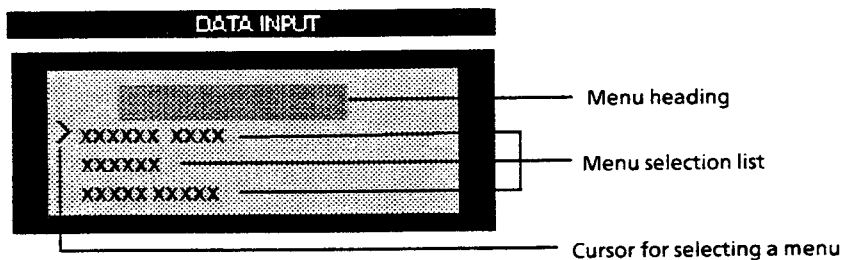

Further entries in the menu selection list can be accessed by way of scrolling the display DATA INPUT

Fig. 3-8 Architecture of the display DATA INPUT

A menu point can be selected using the ↑ and ↓ keys in the operator keypad EDIT. Selecting is performed by placing the cursor ">" on the desired menu or in the case of a table on the respective line and then pressing ENTER or → to call the menu; when it is necessary to input a value, it can be entered using the numeric keypad. When e.g. values are entered into a table, a character can be inserted or deleted at the position of the cursor is placed using INSERT or DELETE.

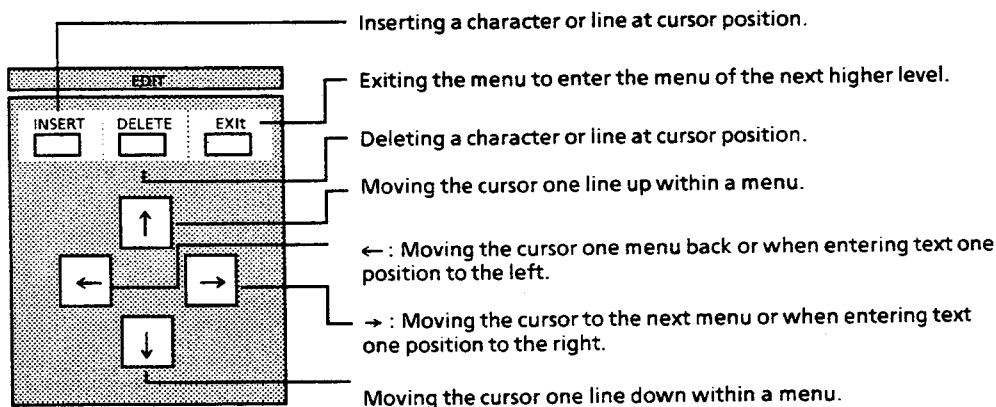

Fig. 3-9

3.2.4.1.2 Input of Texts and Labellings

Transducer factors, limit lines and protocols output on plotter or printer can be given names or labelled by the user. The name or labelling can either be entered via the keyboard that can be connected to the rear panel (cf. section 3.2.6.8) or via auxiliary line editor in the third and fourth line of the DATA INPUT display.

The receiver recognizes automatically whether a keyboard is connected and if so, the auxiliary line editor is not offered for application. Due to the considerably more convenient way of input a keyboard is recommended to be used especially when labelling test protocols.

Operation of the Auxiliary Line Editor:

When using the auxiliary line editor upper-case letters and punctuation marks are displayed in the third line of the display DATA INPUT, lower-case letters and figures in the fourth line. As the space available is not sufficient, the characters not displayed can be made visible by scrolling to the left or right using the cursor keys of the EDIT keypad.



Fig. 3-10

The character desired for labelling is selected using the cursor keys via an auxiliary cursor and inserted at the position of the main cursor () by way of INSERT. The character then appears at the position of the main cursor. The latter moves automatically one position to the right. The respective character that is to the left of the main cursor can be deleted using the DELETE key. Input is terminated by ENTER. The auxiliary line editor then disappears automatically.

3.2.4.2 Configuration of the Receiver (Keypad INSTR STATE)

3.2.4.2.1 Selecting the Instrument Presettings (SETUP menu)

The presettings

- input of date and time,
- selection of the IEC-bus address (IEC 625) and
- display of the firmware version

are indicated or can be newly entered in the SETUP menu.

Operation:

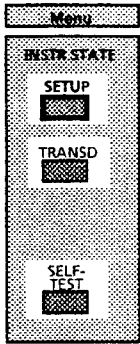

- ▶ Press SETUP key.
The following menu appears in the DATA INPUT display:

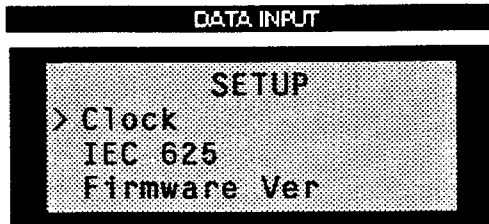

In the last line the firmware version available in the receiver is displayed.

The desired function (clock or IEC 625) is selected by placing the ↑ or ↓ keys of the EDIT-keypad on it and then pressing ENTER or by the → key. The firmware version cannot be selected. A submenu appertaining to each menu point subsequently appears. The respective entries can be made in the submenus.

Setting the internal clock:

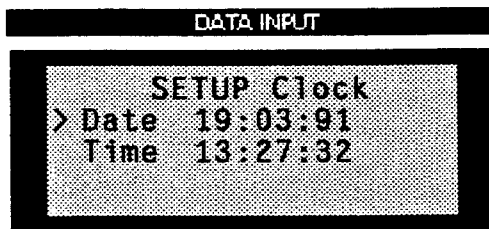

Fig. 3-11 Display of date and time

The current date and time are contained in the realtime clock of the receiver and are displayed after having called the clock function. If a re-entry is required, e.g. following a change of the internal battery, the respective line for the date or time must be selected using the cursors of the EDIT keypad and then input must be performed using the numeric keypad DATA. Illegal entries are ignored, i.e. the former value is retained. The date is displayed in the order day:month:year and time in the 24-hours format hours:minutes:seconds.

After having terminated the input of the date by way of ENTER the cursor moves to time. Following the entry of time the SETUP menu appears again.

Selecting the IEC-bus address:

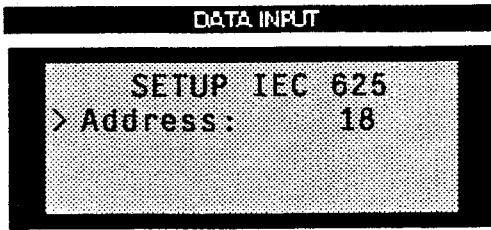

Fig. 3-12 Display of IEC-bus address

Values between 00 and 30 are permissible for the IEC-bus address. The default setting is 18. Illegal inputs are ignored.

3.2.4.2.2 Entering and Calling of Transducer Factors (TRANSDUCER Menu)

When carrying out interference measurements a coupling network, which converts the interfering quantity to be measured into a voltage at 50Ω , is usually connected ahead of the receiver. Coupling networks may be antennas, artificial mains networks or current probes. They often feature a frequency-dependent conversion factor. Transducers with a non-frequency-dependent conversion factor can be coded in 10-dB steps at the ANTENNA CODE connector (cf. section 3.2.5.1). Non-decadic conversion factors must be considered in the transducer factor. The receiver indicates the quantity to be measured that is present at the input of the coupling network, if the transducer is activated.

In the case of the ESVD a distinction is made between **transducer factor**, in the following text abbreviated by "factor", and **transducer set**, briefly "set". A factor consists of points, which are defined by frequency and conversion factor, and the unit that determines the unit of the level display. For frequencies between the known points the transducer factor is approximated using modified spline interpolation.

The unit of the transducer applies to the entire frequency range of the receiver, even if the transducer only covers a part of the range. Outside of the definition range it is assumed that the conversion factor is 0 dB. The receiver therefore delivers illegal measurement values, if the receiver frequencies exceed the transducer definition range. This is indicated by the hint *Warn: Transd undef* in the DATA INPUT display. Moreover, in practice it is futile to use a transducer for measurements in a frequency range in which the transducer can actually not be used.

Up to 22 different factors can be defined and stored permanently. They are provided with a number (1 to 22) and a name that can be specified by the user so that they can be told from each other.

Since in practice the required number of points for the various coupling networks varies, the maximally possible number of values depending on the number of the transducer is grouped according to the following table:

Table 3-8

Transducer number	Number of points
1 to 10	10
11 to 20	20
21, 22	50

These 22 factors can be combined to form sets. Maximally 5 sets are possible. A prerequisite is that all factors combined have either the same unit or the unit "dB". The definition range of a set is divided in turn into ranges. Various factors can be activated per individual range. There may be no gaps between the individual ranges, i.e. the stop frequency of a range must be equal to the start frequency of the following range.

The definition range of the transducer factors used in a certain range must cover it completely.

It is recommended to define a transducer set when different coupling networks are used in the frequency range to be measured or when cable attenuation or an amplifier are also to be considered.

If during a frequency scan a transducer set is defined, a frequency scan is stopped at the intersection between two ranges and the user is requested to change the coupling network (transducer). The following request appears on the display DATA INPUT:

"Connect <Transducer Name>."

If the beeper is activated (special function 13), a short beeping sound can be heard.

The rules according to which the transducer factors can be combined to form sets are summarized with the help of the following examples. The rules are implemented in the ESVD so that the user need not care whether the transducer set entered is valid.

a) Only one single transducer factor is active:

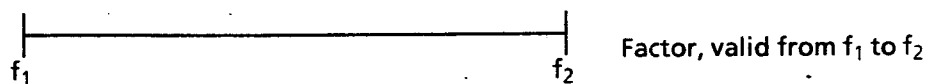

b) Transducer set with several factors lined up in a row:

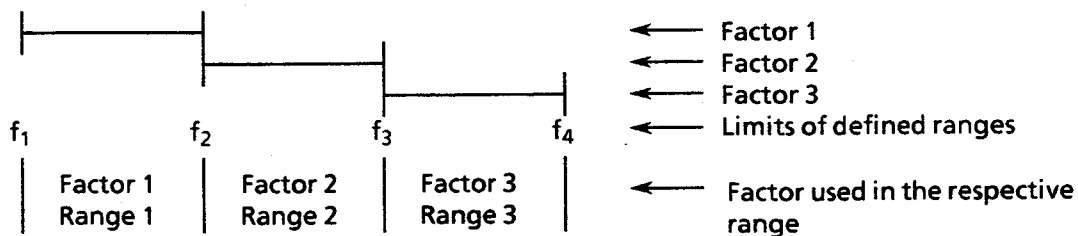

The set is valid from f_1 to f_4 . The units of the individual factors are the same. There are no gaps between the individual ranges.

c) Transducer set with several overlapping factors:

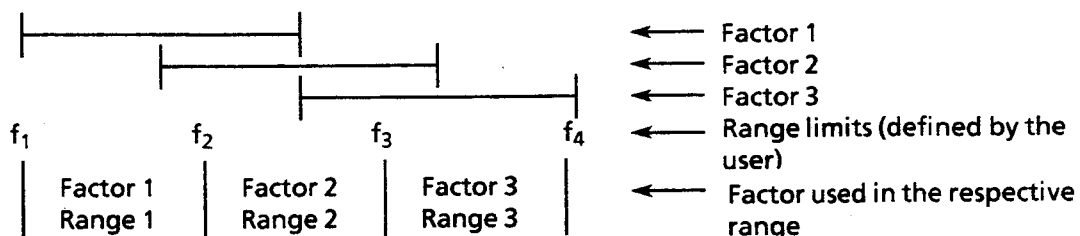

With overlapping factors only those factors that cover a range completely can be activated in it. This applies for f_1 to f_4 with the above-mentioned ranges.

d) Several factors are simultaneously valid:
(set of transducers from f_1 to f_3)

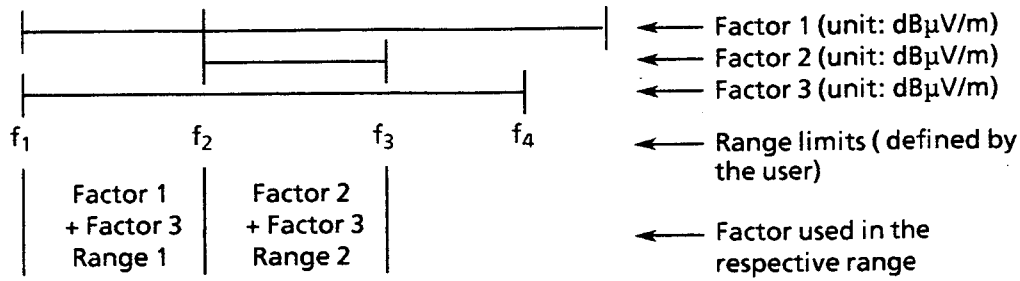

Two factors can be activated simultaneously, when the unit of one factor is dB or when both factors have the same unit. The factor 3 is added to factor 2 or factor 1 in their valid range.

Operation:

Input and editing of transducer factors and sets is called using the TRANSD key (in the keypad INSTR STATE).

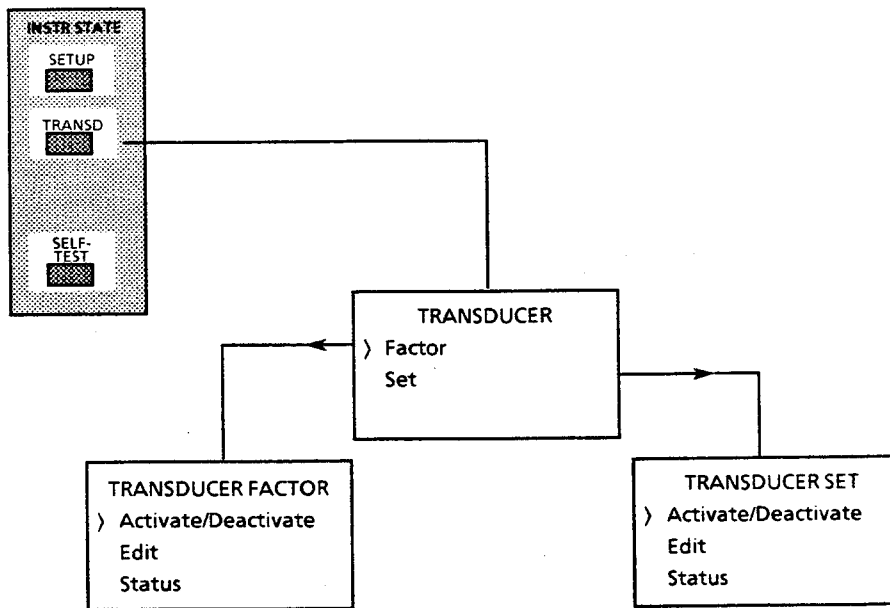

Fig. 3-13 Flowchart for calling the transducer factor

The first few submenus are the same for editing a factor and a set. Here, a factor or a set can be activated (*Activate*) or deactivated (*Deactivate*), changed or newly entered (*Edit*) and the current status can be indicated (*Status*).

Input or Editing of a Transducer Factor:

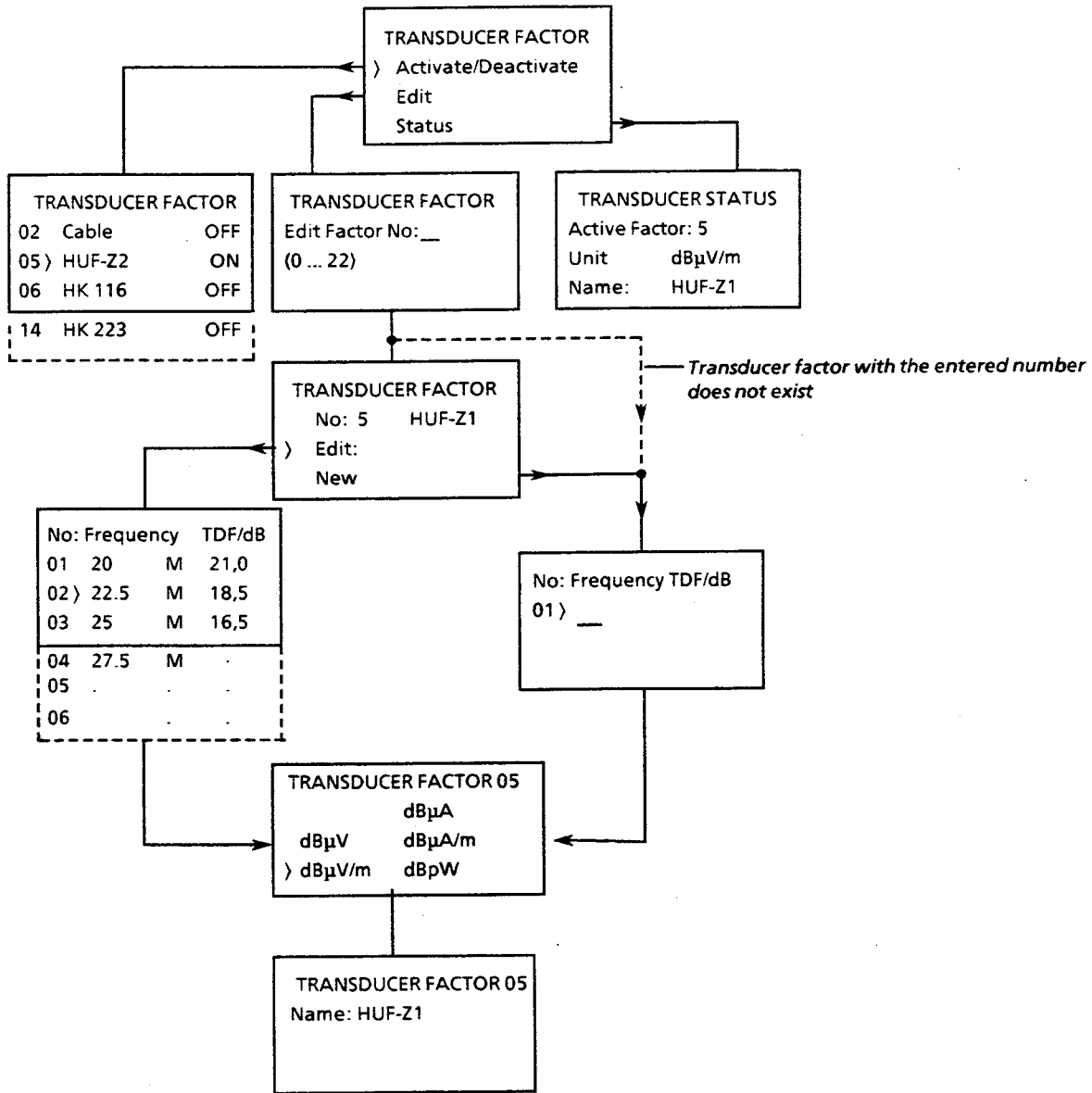

Fig. 3-14 Flowchart for entering or editing a transducer factor

Activate/Deactivate :

In this menu a stored factor is activated or an active factor is deactivated. If a factor is active, the menu point is referred to as *Activate/Deactivate*; if there is no active factor, the name is only *Activate*. After having selected the menu point, a submenu, in which all defined transducer factors with their numbers, names and current status are listed, is called. If no transducer has been defined, the message "None defined" appears in the DATA INPUT display. The cursor is placed on the active factor or, if there is no active one, on the factor with the lowest number. The cursor is placed on the factor to be activated using the ↓ and ↑ keys or by entering the appertaining two-digit number (e.g. "01" must be entered for factor 1). If the factor with the number entered is not defined, the error message "<xx> undef" (<xx> = number entered) appears in the last display line.

The status of the factor is changed by pressing the ENTER key (ON → OFF, OFF → ON). As only one factor or set can be active at one time, an already active factor or set is automatically deactivated, when switching on a factor or set. The menu is exited using the ← key or EXIT.

Transducer Status:

In the menu Transducer Status the current status of the receiver is displayed. In the second line the factor currently active is shown. If a transducer set is active, it is also displayed. If neither any factor nor any set is used, *none* appears in the menu. In the third line the unit and in the fourth line the name of the factor or set used is displayed.

Edit Factor:

In the Edit menu the desired factor for editing is first asked for. This factor must be entered together with its number. If the factor with the number selected does not yet exist, the blank table appears for entering the points. Otherwise, the name of the factor is represented in the following menu and the choice between editing of the factor (*Edit*) and new entry of the factor (*New*) is offered. The factor to be edited is subsequently represented in a table. If new entry has been selected, the table is blank.

**New Entry of
Transducer Factors:**

New entry of factors must be performed in the sequence of increasing frequencies and must be input with frequency and transducer value. The cursor is initially placed on the frequency of the first point. Following frequency input (terminated by MHz) the cursor jumps automatically on the appertaining transducer value.

Values of -200 to +200 are permissible for the transducer. When entering a transducer factor that is higher than 200 dB or lower than -200 dB, the error message "*Max Level 200 dB*" or "*Min Level -200 dB*" respectively appears in the fourth line of the DATA INPUT display. **Amplifiers have a negative conversion factor, attenuation values must be entered as a positive conversion factor.** After having completely entered the point the next one is automatically selected.

If the increasing order is not kept, the error message "*Frequency Sequence!*" is output and frequency input is ignored, i.e. the entry is not accepted and the space remains blank after having terminated the input, thus being available for a new input. If a frequency that cannot be set in the receiver is entered, the error message "*Max Freq 1000 MHz*" is output in the fourth line when the frequency is too high. When entering a too low frequency, the message "*Min Freq 20 MHz*" is output. Points that have been already present are changed by selecting them using the cursor and then entering a new value.

If the maximum number of points has been entered, the input menu is automatically exited. It can, however, already be exited by pressing the ENTER key while the cursor is in a blank frequency field or by means of the → key. The following submenu subsequently offers a number of units that are possible for the newly entered factor. The desired unit is selected by placing the cursor on it using the ↑ and ↓ keys and pressing ENTER.

The factor can finally be given a name (*Name*). Input can either be performed via the external keyboard or via the auxiliary lines for text input (cf. section 3.2.4.1.2), if the keyboard is not connected. Maximal eight characters are permissible for the name. If no name is desired, the field *Name* can be kept blank. Definition of the transducer factor is complete, when having pressed ENTER after input of the name.

**Editing of
Already Existing
Transducer Factors:**

While editing a transducer factor a point can be deleted, a new one can be inserted or only a frequency or a transducer value can be changed. Inserting or deleting is possible, when the cursor points to the number of the point. The respective point is deleted using the DELETE key and all the subsequent values move up. A blank line is created at the position of the cursor using INSERT and all following points are raised by one number.

When entering the new frequency in the new line it must be ensured that the frequency order is kept to as otherwise input is not accepted. In this case the error message "*Frequency Sequence!*" appears in the last menu line. If the transducer factor has already the maximum possible number of points, it is no longer possible to insert a new one. When trying nevertheless, the error message "*Max <xx> values*" appears in the lowest line (<xx>: the maximum number of points depending on the number of transducer factor, cf. table 3-8).

A frequency or a transducer value can be changed when placing the cursor on the desired number. When entering a figure the old frequency is deleted and the new one is displayed. Stick to the increasing frequency sequence in this case, too. When pressing ENTER without having entered a number before, the cursor jumps to the factor value that can then be input anew.

The EDIT menu is exited either by way of the → key or, when the cursor is on the last point by pressing ENTER. The menu for the unit appears (cf. new entry of transducer factors).

Generating or Editing a Transducer Set:

The structure of menus for editing a transducer set is similar to that of a factor. *Activate/Deactivate* and *Status* lead to submenus in which only factor is replaced by set. Operation and function are analog to that of the transducer factor. Only EDIT menus differ from those of the transducer factor.



Bild 3-15 Flowchart for generating/editing a transducer set

Edit:

In the EDIT menu the set that is to be edited is first asked for. The desired set must be entered together with its appertaining number. If no set with the selected number exists, the blank table for entering points appears. Otherwise the name of the set is displayed in the following menu and the user can chose between editing the set (*Edit*) and entering a new set (*New*). With sets that do not yet exist only new entry is permitted.

New Entry of Transducer Sets:

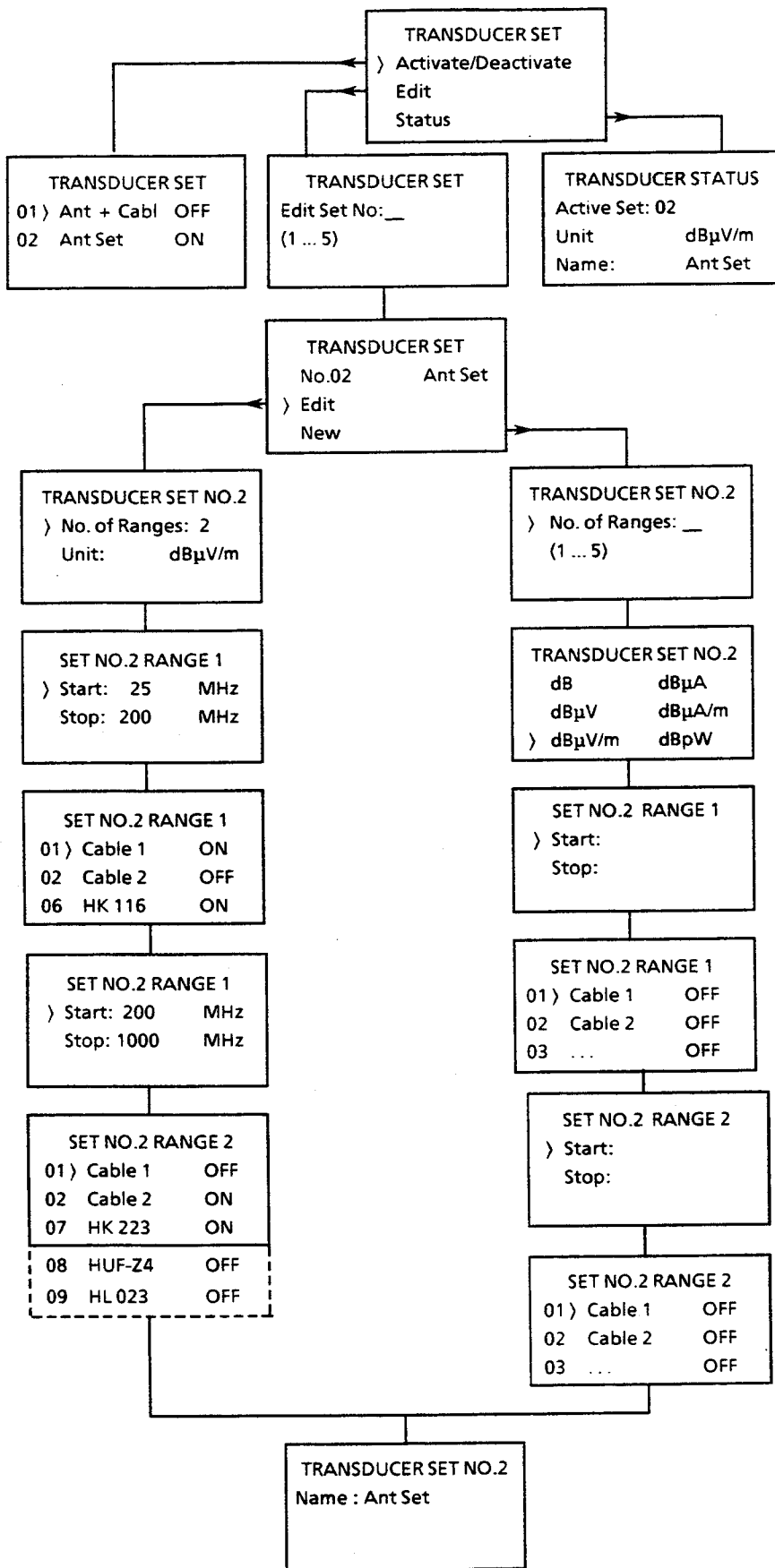
No. of Ranges:

When entering transducer sets for the first time, the number of ranges which the transducer set comprises is requested in a menu. Up to five ranges are possible. With the entry of the desired number the next menu appears, in which the unit of the set is specified. The unit is selected by the cursor via the ↑ and ↓ keys and input using ENTER.

The frequency limits of the individual ranges for the set and the factors active in the range are subsequently input one after the other starting with range 1. As there may not be any gaps between the individual ranges, the start frequency is already pre-determined from the second range (stop frequency of the preceding range).

In the list from which the factors can be selected for the range currently to be edited **only those factors that are matched to the unit of the set and are defined over the entire individual range** are available. These factors are indicated in the status Off. The desired factors are selected by the cursor and their status is switched over using ENTER (OFF → ON). The menu is exited using the → key. If no factor has been activated in a range, the transducer in this range will be set to 0 dB. The unit is the one defined for the entire set.

Name:

After having entered all ranges the set can be provided with a name (*Name*). Input is possible either by the external keyboard or by the auxiliary lines for text input (cf. section 3.2.4.1.2), if the keyboard is not connected. The name may consist of maximally 8 characters. If no name is desired, the field may remain blank (merely pressing ENTER).

Editing of Already Existing Transducer Sets:

When editing a transducer set the number of the ranges (*No. of Ranges*) and the unit (*Unit*) of the set appear in the menu. The number of ranges may be altered, the unit however not as this would correspond to a new entry. It is possible to move from one point to the other within each individual range using the ↑ or ↓ keys. The cursor can be moved from menu to menu using the → or ← keys. The individual menus have the same structure as those for new entry. Start and stop frequencies of the individual ranges can be changed by selecting the corresponding menu point and directly entering new values.

When pressing the ENTER key the old value is retained and the cursor jumps to the next line. When changing the stop frequency the start frequency of the next range is also automatically changed. In the case of the ranges 2 to 5 the start frequency cannot be changed as there may not be any gaps between the individual ranges. The status of the factors that are possible in the various ranges is switched over in the same way as with new entry.

Note: *When the frequency limits of the individual ranges are changed, it may occur that transducer factors that used to be active in a range are no longer permissible as their definition ranges do not cover the range. These factors do no longer appear in the selection list. After having edited the last defined range it is possible to change the name of the set (cf. new entry).*

3.2.4.2.3 Calling the Self Test (SELF TEST Menu)

The ESVD is equipped with a wide variety of self-test functions that can detect an instrument error even if it is on module level. The self-test runs independently while the functions that build up on one another are tested in turns starting from the lowest function level. When a faulty function is detected, it is indicated on the DATA INPUT display with a hint to the respective module (*ERR: <Module>*). Only one error can be detected as the following tests cannot be carried out correctly, if there was a faulty function. To avoid unfounded error messages the self-test is aborted following the detection of the first error. Complete instrument settings can be called to allow for convenient setting of the modules in the case of replacement.

The run of the self-test, possible error messages and replacement of modules are described in detail in section 4.

Operation:

The self-test menu is entered by way of the SELFTEST key in the keypad INSTR STATE. The desired function is called either by entering the appertaining number of by way of the cursor. The status of the calibration generator (*CAL Gen*) and of the calibration correction values is switched over. When exiting the menu by means of EXIT, the default operating status is automatically re-established (cf. menu).

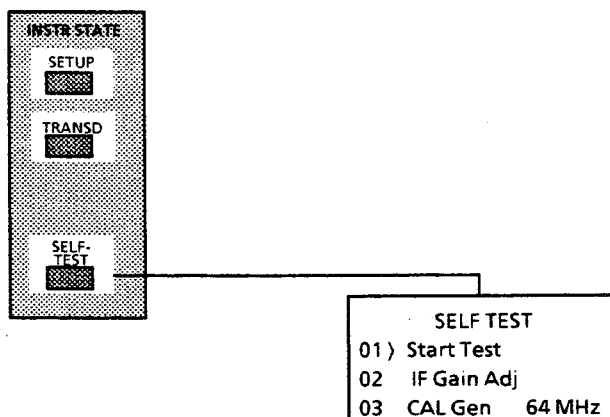

Fig. 3-16 Calling the SELF TEST menu

3.2.4.3 Execution of Frequency Scans (Keypad ANALYSIS)

One of the most important features of the ESVD is the ability to perform independent frequency scans with setting data varying from range to range. A test report can be output in the form of a diagram and/or a table either by means of a printer or a plotter or using both. Limit lines can be defined in accordance with the rules specified for the respective measurement and also be output. The frequency scan can be adapted to the specific measurement problem with the help of various analysis options (*Options*)

3.2.4.3.1 Generation and Editing of Data for a Frequency Scan

A data set for a frequency scan can consist of up to five partial scans, which are defined by the start frequency, stop frequency and step size. The latter can either be linear (*LIN*) or logarithmical (*LOG*). With logarithmic setting it is entered as a percentage of the respective receiver frequency. The remaining receiver parameter such as bandwidth, detector, operating range, attenuation, mode and measuring time are set in the receiver during definition of the partial scan in the same way as in manual mode, i.e. those receiver parameters that are selected at the time the input is terminated or when leaving the range are used in the partial scan. (Confirmation of the question *Rec settings ok?* using a key in the ENTER area).

Minimum level (*Min Lev*) and maximum level (*Max Lev*) must finally be defined for the complete scan data set. These two levels determine the display range of the plotter or printer output. They are always entered in dB. The unit follows from the unit that is valid for the measurement and depends on the transducer, antenna code or on special functions set.

The scan data set is stored in the RAM with battery backup. Thus it is available again following switch-off of the receiver. If no scan data set was defined or when having called default setting using RCL0, the default data set is automatically set. It consists of one range with the following settings:

Table 3-9

	Scan No 1
Start frequency	20 MHz
Stop frequency	1000 MHz
Step size	50 kHz
IF bandwidth	120 kHz
Attenuation	AUTO, Low Noise
Operating range	60 dB
Detector	Pk
Measuring time	10 ms
Preamplifier	off

Operation:

The menu which offers initial input (*New Set*) and editing (*Edit Set*) of a scan data set is called by pressing the SCAN key in the ANALYSIS keypad. Depending on the selection the different menus for editing or new entry of a data set are offered one after the other until the data set is complete.

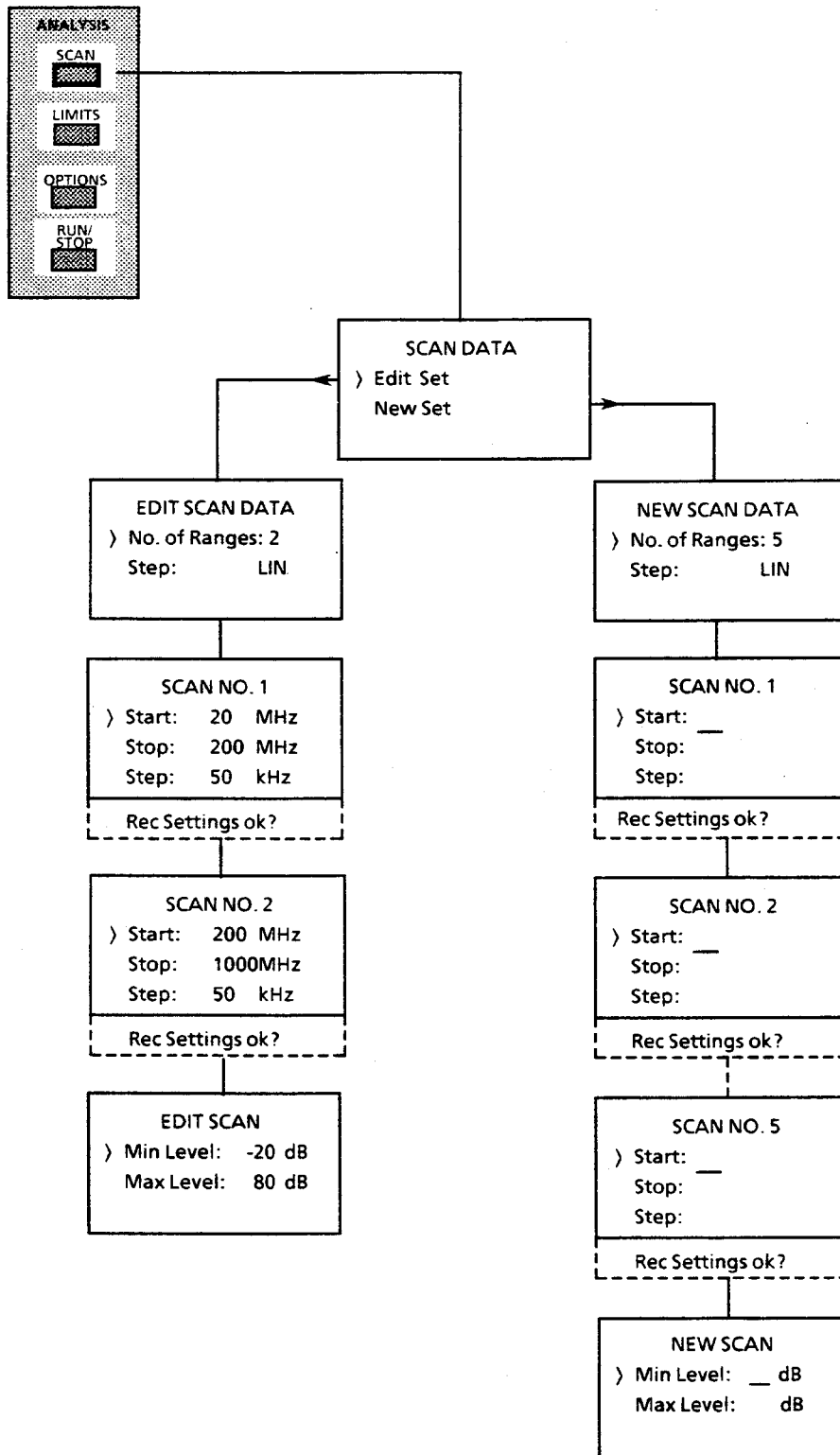

Fig. 3-17 Flowchart of the menus EDIT SET and NEW SET

New Entry of a Scan Data Set:

When entering a new scan data set, the number of ranges (*No of Ranges*) which the scan data set is to contain and the type of frequency scan (linear or logarithmic) is first requested. The default values are 1 range and linear frequency scan.

No. of Ranges

The number of ranges may be 1 to 5. Frequency scan is set to logarithmic (LOG) by pressing a key in the ENTER area when the cursor is placed on *Step*. Following the selection of the logarithmic step size the sweep step size in each partial scan must be entered in per cent. The range of values for step size is 0.1 % to 100%. (100 %, 50 %, 25 %, 12.5 % ... 0.1 %). If the user enters a step size other than the ones stated above, the next lower step size is automatically set.

Start Stop

When pressing the → key the next menu is entered, in which start frequency, stop frequency and step size of the first partial scan is requested. They are respectively entered together with their unit or in per cent. Unless all parameters requested are entered, the next menu cannot be entered.

Rec Settings ok?

Following the input of all values the question whether all receiver parameters for the partial scan have been correctly set (*Rec Settings ok ?*) appears in the last line of the menu. The user can thus make sure again that all front panel settings are correct before he presses a key in the ENTER area to affirm the question and thus switches to the next menu.

If ENTER is used, all current receiver settings made for the partial scan - with the exception of the frequency - are adopted for the next partial scan and it is also switched to the next menu. The start frequency of this partial scan (= stop frequency of preceding partial scan) is already set, as there may be no gaps between the individual partial scans. Scan input is terminated when the settings of the last partial scan that is defined in *No. of Ranges* have been entered.

If the stop frequency of a preceding partial scan is already 1000 MHz or 2050 MHz, 1000 (2050) MHz for the start and stop frequency and 0 kHz or 0 % for the step size is then automatically input in the following ranges. The receiver considers the ranges to be non-existing. Entries can be affirmed by way of ENTER. It can be switched directly from menu to menu using the → key. It is also possible to define several partial scans in this way. The user can intentionally create scan data sets of this kind to have dummy-partial scans, which can be used, if required. It is thus not necessary to enter anew a complete scan data set.

Max Lev/ Min Lev

The minimum and maximum level for scaling the diagram that is output via printer or plotter must be entered in the last menu. Multiples of 10 are only permissible. Deviating inputs are automatically rounded off (minimum level) or rounded up (maximum level). The minimum display level that can be entered is -200 dB, the maximum one is +200 dB. The unit is the one that is currently valid for the receiver. The minimum display range (*Max Lev - Min Lev*) is 10 dB.

Editing an Already Existing Scan Data Set:

As with new entry the number of ranges and type of frequency scan (linear or logarithmic) of the already existing data set is displayed in the first menu.

When increasing the number of ranges, further ranges can be added directly with higher values; when decreasing the number, the ranges with the highest values are deleted.

Step After having exited the menu (→ key) the first defined partial scan appears. At the same time all receiver settings defined for this partial scan are set in the ESVD and displayed.

Start
Stop If the partial scan that is to be changed is already known, the menu can be quickly scrolled through using the → key. If, however, the type of frequency scan is changed, the step size must be entered in each partial scan as it is deleted. Unless this is done, the partial scan menu cannot be exited. Start frequency, stop frequency and step size can be edited by selecting the corresponding menu point by way of the cursor and immediately entering new values. When pressing a ENTER key the old value is retained and the cursor moves to the next line.

Changing the stop frequency changes the start frequency of the next partial scan. From the second partial scan onward the start frequency cannot be changed anymore as there may not be any gaps between the individual scans. It can only be changed by entering a new stop frequency for the preceding partial scan.

Rec Settings ok ? The question whether all receiver parameters for the partial scan have been correctly set (*Rec Settings ok ?*) appears in the last line of each menu. The user can thus make sure again that all settings are correct before pressing ENTER to affirm the question and to switch to the next menu.

Min Level
Max Level Level display range (*Min Level* or *Max Level*) for output of diagrams can be modified in the last menu for editing the scan data set.

3.2.4.3.2 Input of Limit Lines

The various regulations covering interference measurements include limit values that may not be exceeded. With logarithmic frequency display these values are usually composed of straight lines. In some standards several limit values are specified, e.g. a limit value for quasi-peak and one for average weighting.

The ESVD allows to define and store remanently up to 22 different limit lines. In order to distinguish the different lines they may be supplied by a number (1 to 22) and a name (max. 8 characters).

As in practice the necessary number of points for the limit values is specified differently in the various standards, the maximum possible number of values depending on the number of the limit line is grouped according to the following table:

Table 3-10

Number of Limit Value	Max. Points
1 to 10	10
11 to 20	20
21, 22	50

Two of these 22 limit lines can be activated for measurement. If a name is specified for the limit value (max. 8 characters), it is also output in the test diagram.

The defined limit lines are stored in the RAM with battery back-up and can be activated or deactivated, if required.

Activated limit lines are used to determine whether limits were exceeded during final measurements in the RF analysis and in the special function 16 (*Check Limit* see chapter 3.2.3.13). With double test modes, the test receiver automatically assigns the detector to the limit line which is to be compared. When this occurs, the detector which measures the higher level refers to the limit line with the larger value.

Operation:

New entry or editing of limit lines is called by pressing the LIMITS key in the ANALYSIS keypad. In the appertaining main menu the user can select between activating or deactivating (*Activate/Deactivate*), editing (*Edit*), i.e. new entry or changing of limit lines. Furthermore it specifies the current status of the receiver relating to the limit lines.

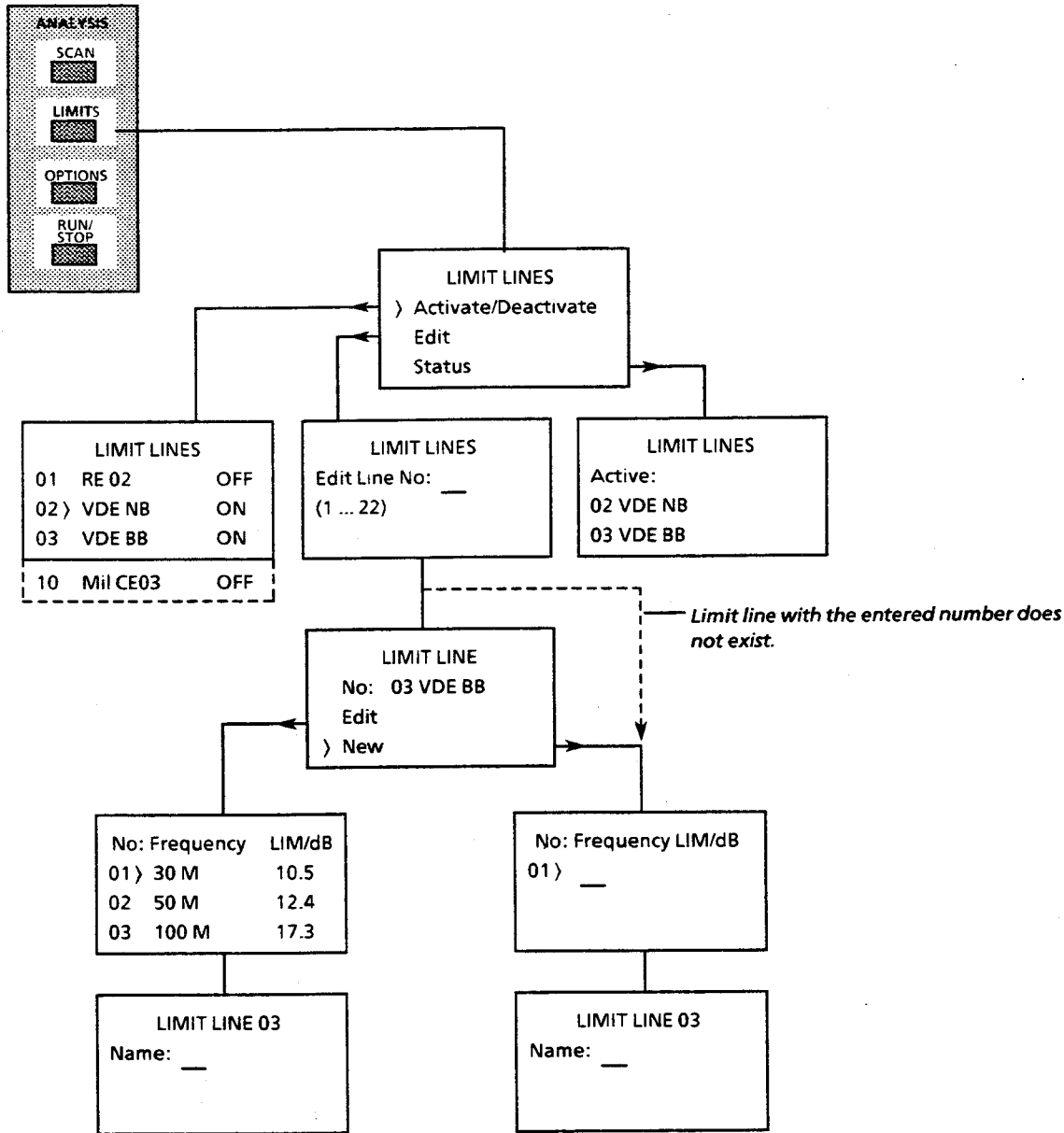

Fig. 3-18 Flowchart for new entry or editing of limit lines

Activating / Deactivating of Limit Lines
(*Activate/Deactivate*):

In this menu a stored limit line is activated or an active limit line is deactivated. If there is an active limit line, the name of the menu point is *Activate / Deactivate*; if there is no active one, the menu is only referred to as *Activate*. After having selected the menu point a submenu, in which all the defined limit lines together with their number, name and current status are listed, is called. If there is no defined limit line, the message "None defined" appears in the display. The cursor is placed on the active limit line with the lowest number, or, if there is no active one, on the line with the lowest number of all limit lines.

The cursor is placed on the factor to be edited using the ↓ and ↑ keys or by entering the appertaining two-digit number (e.g. 01 must be entered for factor 1). If the factor with the number entered is not defined, the error message "ERR: <xx> undef" (<xx> = number entered) appears in the last line of the display. The status of the limit line can be changed (ON → OFF, OFF → ON) by pressing the ENTER key. If there are two active limit lines, the cursor jumps automatically to the second active line after having deactivated a line.

Only two limit lines, respectively can be active at one time. When trying to activate a third one, the error message "Max 2 Limits" is output. Before activating the desired limit line an already active one must be deactivated. The menu is exited using the ← key or EXIT.

Editing of Limit Lines:

When calling the EDIT menu the limit line to be edited is requested in the first sub-menu. It must be entered by its appertaining number. If there is no limit line with the selected number, the blank table for entering the points appears. If a limit line with the selected number does already exist, its name is output in the following menu and a selection between editing (*Edit*) and new entry (*New*) is offered. In the case of new input the blank table appears. If "New" was selected by mistake, the former limit line may be restored by pressing the ← key prior to complete input of the first point.

New Entry of Limit Lines:

New entry of limit values must be performed in the sequence of increasing frequencies with frequency and level of the limit value. The cursor is placed on the frequency of the first point at the beginning. Following frequency input (terminated by MHz) the cursor jumps automatically to the appertaining level value. Values of -200 to +200 are permissible for the level. When exceeding these limits the error messages "Max Level 200 dB" or "Min Level -200 dB" result. The input unit is always dB, i.e. the unit of the limit value is adapted to the unit valid during measurement, which usually depends on the transducer used. After having completed input of the point the cursor jumps automatically to the next one.

If the increasing order is not adhered to, the error message "Frequency Sequence!" is output and the frequency input is ignored, i.e. entry is not accepted.

If the maximum number of points has been entered, the input menu is automatically exited. It can also be exited beforehand by pressing the ENTER key while the cursor is in a blank frequency field or by using the → key. The limit line can finally be provided with a name (*Name*) in the following submenu. Input can be performed either via the external keyboard or via the auxiliary lines for text input (cf. section 3.2.4.1.2), if the keyboard is not connected. Maximal 8 characters are permitted for the name. If no name is desired, the field *Name* may be left blank.

Editing of Already Existing Limit Lines:

When editing limit values a point can be deleted, a new one can be inserted or only any frequency or level value can be changed. Inserting or deleting a point is possible, when the cursor points to the number of the point. It is deleted using the DELETE key and the subsequent values move up. A free line is created at the position of the cursor using INSERT and all following points are raised by one number. When entering the new frequency in the new line it must be ensured that the frequency order is kept as otherwise input is not accepted. If the limit value has already the maximum possible number of points, it is not possible to insert a new one. In this case the error message "Max <xx> values" (<xx>: the maximum number of points which is dependent on the number of the limit line, cf. table 3-10) appears in the bottom line.

A frequency or a limit value can be changed when placing the cursor on the desired position. When entering a figure the old value is deleted and the new one is displayed. Stick to the increasing frequency sequence in this case, too.

The EDIT menu is exited either by way of the ← or → key or, when the cursor is on the last point by pressing the ENTER key. The menu for the name appears in the DATA INPUT display (cf. New Entry of Limit Lines).

Display of Active Limit Lines: In the menu Limit Status the limit lines currently activated are indicated in the second and third line. They are represented together with their number and name, if the latter is defined. If no limit line is activated, *none* is indicated in the menu.

3.2.4.3.3 Extended Functions of RF Analysis (OPTIONS)

The *Options* of the ESVD offer new functions that serve for adapting the RF analysis to specific measurement problems or to optimize measurement runs for various applications. A significant feature is data reduction. It is achieved by dividing the frequency range into subranges. During a pre-test the maximum interference is searched for in a subrange. A measurement is immediately carried out at this maximum in the desired indicating mode - usually quasipeak or average value. In any case it is thus ensured that the highest interference levels are measured with weighting. The relatively time-consuming measurement procedures must however only be carried out with a limited number of frequencies, so that total test time is considerably less. In the case of RFI voltage measurements with artificial networks it is also possible to switch over the phase for weighted measurement, if required. This ensures that the highest interference is detected. The user himself largely determines the measurement run by combining the various options in different ways. Thus the number of subranges (max. 400), parameters of the pre-measurement, type and phases of artificial network, type of weighted measurement and its measuring time and the threshold value for which a weighted measurement is to be performed can be freely determined by the user. How to carry out the measurement is described in section 3.4.

Operation:

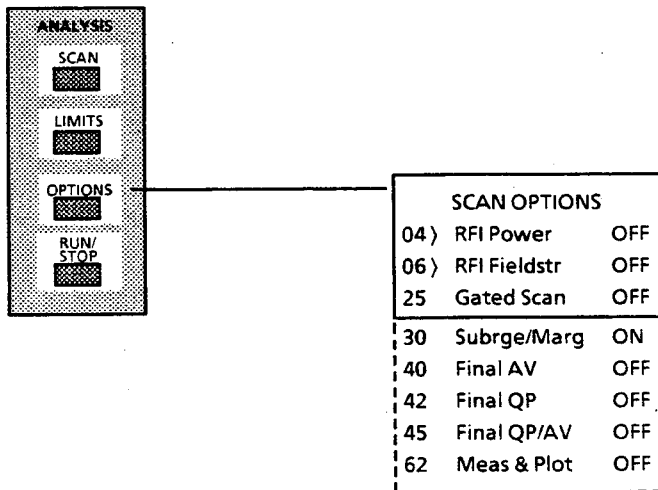

Fig. 3-19 Calling the SCAN OPTIONS menu

The cursor is placed on the desired option using the ↑ and ↓ keys or it is directly entered using its number. The status of the scan options is switched over by way of ENTER (OFF → ON, ON → OFF). Some of the scan options require additional entries. In this case, a submenu in which the necessary values can be input is called during switch-on. The main menu is exited when calling any other menu or by way of the EXIT key.

OPT 04, RFI Power:

With this option, the ESVD together with an absorbing clamp and a plotter and/or printer allows for semi-automatically carrying out a complete RFI voltage measurement with documentation of the measurement results. (How to use the function, cf. section 3.4)

OPT 06, RFI Power:

This option supports RFI fieldstrength measurements in an RF cabin. (cf. section 3.4 for application of this option)

OPT 25, Gated Scan:

Default setting of the option is OFF.

With the option switched on, frequency scan starts with a positive edge at the input "External Trigger" (pin 1) of the USER INTERFACE. It continues as long as HIGH level is applied to the input. When the level changes to LOW, frequency scan stops. Following the next positive edge it starts again at the position where it was interrupted.

The function contributes to a considerable reduction in measuring time required for devices under test featuring intermittent interference or systems which are only irregularly activated. The trigger level must be generated by the device under test, itself.

OPT 30, Subrge/Margin:

Default setting of the option is ON.

This option is used in connection with option 01. The user can specify the number of subranges (*Subrge*) at the maximum levels of which a final test is to be carried out and the level margin (*Acc Margin*) compared to the limit line at the frequency from which onward measurement is carried out. Application is described in section 3.4 in connection with option 01.

Operation:

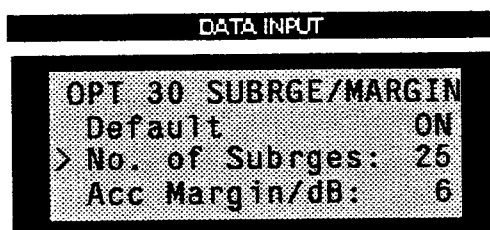

When calling option 30, a submenu appears, in which the required number of subranges and the difference relating to the limit line from which onward a weighted measurement is carried out can be entered. The values of the default setting are 25 subranges and a margin of 6 dB with respect to the limit line. New values can be input by placing the cursor on the desired line and entering a new value.

The permissible values for the number of subranges are 8, 16, 25, 50, 100, 200, 400 (maximum value). When entering a value other than the ones stated above, it is rounded up or down to the next permissible one. For the margin to the limit line all the values between -200 dB and +200 dB are permissible. A positive value leads to a margin that is below the limit line.

The menu can be exited using EXIT.

- Option 40: Final AV
- Option 42: Final QP
- Option 45: Final QP/AV:

Default setting is OFF.
 With the options 40, 42 and 45 ON, quasipeak measurement, average measurement or both is automatically effected at the maximum levels of the subranges following a measurement with scan. One function only can be switched on at one time. When activating one option, the other two are automatically switched off. The options directly influence the scan parameters of the final measurement. Weighting depends on the activated option and is performed using the following detectors:

Option	Detektor for final measurement
40 Final AV	AV
42 Final QP	Pk
43 Final QP/AV	Pk + AV

Application is described in section 3.4.

Operation:

- ▶ Place the cursor on one of the options 40, 42 or 45:
- ▶ Press ENTER.
 With option 45 for example, the following submenu is called:

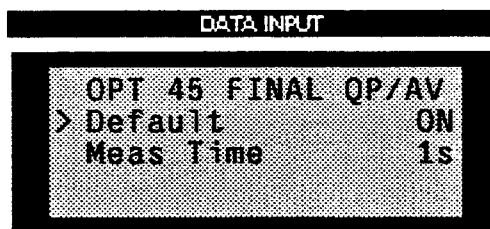

In this submenu measuring time required for measuring again at the maximum levels of the subranges is specified.

- ▶ Place the cursor on *Meas Time* for this purpose and then enter the desired measuring time.
- ▶ Set the basic setting (cf. menu) by way of *Default*.

The menu is exited using EXIT or ← and option 45 is displayed with ON in the option menu. When pressing ENTER while the status is ON, the option is deactivated (status OFF).

Option 62, Meas & Plot:

Default setting of the option is OFF.
 To allow to follow the measurement run, the measurement curve can be output on plotter during frequency scan. Labelling and graticule are output prior to the measurement curve.

If no plotter is connected or it is set to another address than specified in the SETUP menu, the message *ERR:No Plotter* appears in the display DATA INPUT. After having connected a plotter the scan is started by pressing a key in the ENTER area. When pressing only a ENTER key measurement is started without a plot.

When starting the scan everything defined under the point *Report Setting* in the menu *Plot Contents* is plotted. If *Curve* is not activated in this menu, a warning results: "*Warn: Curve OFF*"

Option 63, Special Scan:

When *Special Scan* is selected, one measurement at each of the frequencies defined in a frequency data set is carried out with the desired receiver settings. Thus it is possible to obtain a measurement result in minimum time, if the frequencies of emitted interferences are known.

Example:

Measurement of emitted interference at the clock frequency of a processor.

Frequencies for the special scan are entered using the SCAN key. Input menus are different from those of a conventional scan.

Operation:

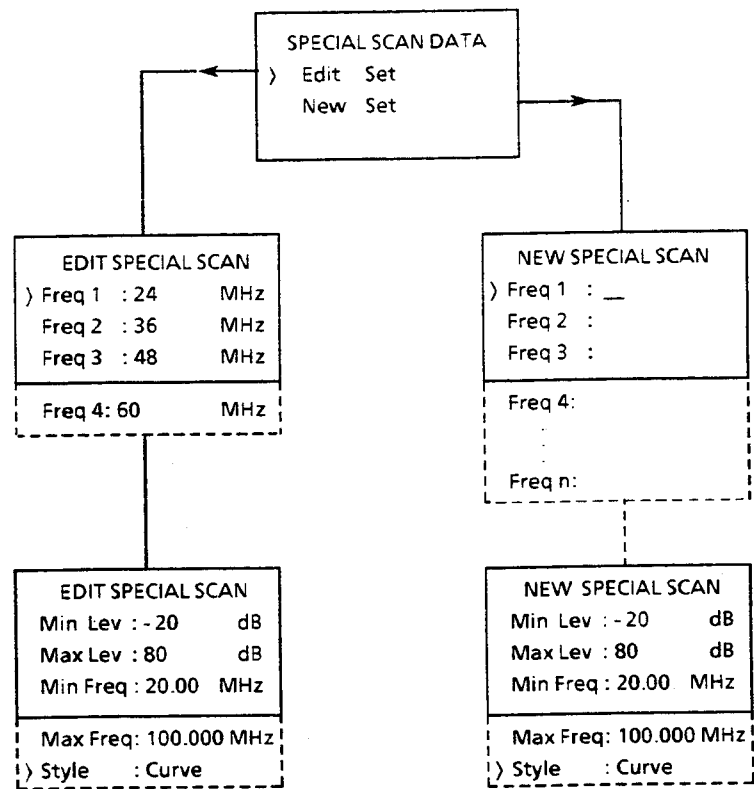

Fig. 3-20 Flowchart for input of a special scan

In the first menu it is possible to select between editing of an already existing data set and new entry. The following menus are essentially the same.

400 frequencies at the most can be entered. The individual frequencies must be entered in increasing sequence. Frequency inputs that are not in line with this order are not accepted. The error message *Freq Sequence!* results. When editing the data set, it is possible to insert additional frequencies using INSERT or delete them by way of DELETE.

The edit menu is exited by way of the ← or → keys or, if the cursor is on a blank input line or on the maximum possible interpolation value by the ENTER key.

Following the input of all frequencies, level and frequency limits must be entered for plotter or printer output.

The *Style* function allows you to select the way a measurement curve is represented on a printer or a plotter. Pressing the ENTER key switches between closed curve sections (*Curve*) and small vertical lines (*Line*).

OPTION 80, Triggered SCAN: Default setting is OFF.
 (only via IEC bus together
 with SPEC FUNC 53,
 cf. sect. 3.2.3.13, manual
 operation not possible)

This option in conjunction with special function 53 is suited for recording position-dependent fieldstrength patterns of various transmitter stations. In only one test tour the fieldstrength patterns of several base stations, e.g. in the GSM network can be determined.

Option 80 allows to define a data set with 1 to max. 20 frequencies, which are triggered externally and set cyclically in increasing sequence. The maximum trigger rate depends on the selected IF bandwidth and the highest frequency step within the data set. Besides, all the frequencies must be within one of the receive ranges specified in table 3-12 as otherwise the synthesizer cannot be switched at such a high rate. The frequency bands of the cellular radio networks (C network, GSM network, PCN uplink and PCN downlink) or of the VHF band are each covered by one range.

Table 3-12

Frequency range/MHz	Frequency range/MHz
20 to 51.2999	1000.0001 to 1025.9999
51.3 to 125.2999	1026 to 1100.9999
125.3 to 199.2999	1101 to 1175.9999
199.3 to 273.2999	1176 to 1249.9999
273.3 to 347.2999	1250 to 1319.9999
347.3 to 421.2999	1320 to 1394.9999
421.3 to 495.2999	1395 to 1469.9999
495.3 to 569.2999	1470 to 1521.9999
569.3 to 643.2999	1522 to 1599.9999
643.3 to 717.2999	1600 to 1689.9999
717.3 to 791.2999	1690 to 1759.9999
791.3 to 865.2999	1760 to 1794.9999
865.3 to 889.2999	1795 to 1889.9999
889.3 to 1000	1890 to 2004.9999
	2005 to 2050

The following figure illustrates the measurement sequence:

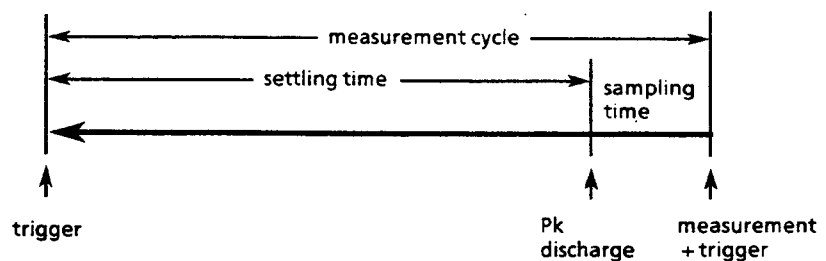

The sequence of a measurement on a frequency consists of the time required for internal settling processes of synthesizer and IF filter (settling time) and the time required for the measurement itself (sampling time). Both times must be defined depending on the maximum desired measurement rate, the maximum frequency step within the predefined frequency data set and the set IF bandwidth. The minimum settling times are given in the following table.

Table 3-12a

IF bandwidth	Max. frequency step	Min. settling time
1 MHz/300 kHz	25 MHz	2.3 ms
1 MHz/300 kHz	50 MHz	4 ms
1 MHz/300 kHz	> 50 MHz	6 ms
120 kHz	25 MHz	3 ms
120 kHz	50 MHz	4 ms
120 kHz	> 50 MHz	6 ms
10 kHz	5 MHz	10 ms
10 kHz	10 MHz	15 ms
10 kHz	50 MHz	25 ms
10 kHz	> 50 MHz	30 ms

The minimum value for the sampling time is 100 μ s. The maximum value depends on the required settling time. Sampling time plus settling time must not exceed 32 ms.

Total time needed for a measurement is computed by adding 100 μ s, which are required for the discharging of the peak value detector or settling of the average value detector and the switch-over of IF gain in autorange mode.

The measured value of the preceding measurement is output during the settling time. To avoid violation of the set time grid, the process controller must be able to accept the measurement data within this "time window".

While starting the measurement (A/D conversion) the trigger pulse for the measurement on the next frequency can already be applied.

The maximum trigger rate can be determined from the value specified for the minimum settling time in table 3-12a and the minimum sampling time plus 100 μ s. With e.g. an IF bandwidth of 300 kHz and frequency steps of up to 25 MHz the trigger rate is 2.5 ms (2.3 ms + 100 μ s + 100 μ s). This setting allows to simultaneously perform measurements on 4 base stations with a rate of 100 measurements/second for each base station.

For practical operation select the times as long as to achieve the maximum required measurement rate while increasing proportionally both settling time and sampling time. In the case of 100 measurements per second which are to be performed only on two frequencies with an IF bandwidth of 300 kHz within the GSM downlink band (935 to 960 MHz), for example, this means that both settling time and sampling time are to be doubled.

The process controller is responsible for adhering to the minimum times.

The sequence of the level measurement is the same as with the use of special function 53 only.

As against special function 53 autorange operation has been extended by the following: The ESVD memorizes the IF attenuation setting appertaining to each frequency and sets it optimally for the next measurement performed on the respective frequency in line with the procedure described under special function 53.

IEC bus operation and measured value output are referred to in section 3.5.

3.2.4.3.4 Frequency Scan

A scan is started by pressing the RUN/STOP key. It runs in accordance with the set special functions (cf. section 3.2.3.13), transducer factor or transducer set (cf. section 3.2.4.2.2) and options. If several ranges are defined in an active transducer set, the receiver stops at the range intersections and requests changing of the transducer. The data measured are stored in the internal RAM (cf. Options and section 3.4) Max. 30.000 measured data can be internally stored. If more measured values are produced, they are not available any more for further processing (e. g. subsequent output via the IEC bus). Nevertheless, a complete diagram is always output, since only the 400 upper values of the scan are required. The stored data get lost, when switching off the receiver.

Operation:

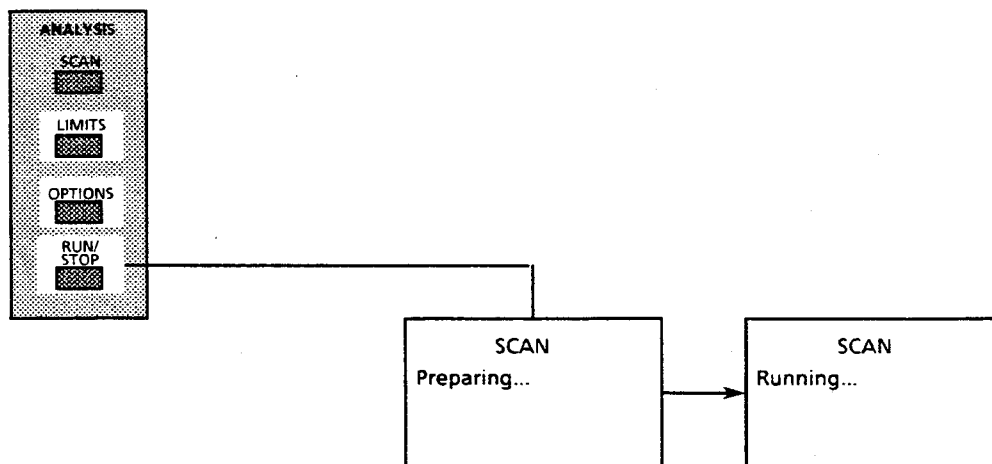

Fig. 3-21 Calling the SCAN menu

- ▶ Press RUN/STOP key.
Frequency scan is initiated. At the beginning the ESVD generates a data set which contains the correction values consisting of frequency response correction values from the total calibration and transducer factors for all frequencies. While establishing the data set *Preparing...* is indicated in the DATA INPUT display. Subsequently the frequency scan starts. The DATA INPUT display shows *Running...*
- ▶ Press RUN/STOP key.
Frequency scan stops. The receiver can now be operated manually to allow e.g. closer examination of the receive signal at a frequency by monitoring or switching over of the detector or measuring time. The following menu appears in the DATA INPUT display:

```

DATA INPUT
-----
SCAN
Interrupted..
> Cont at Interrupt
  Cont at Rec Freq

```

- ▶ Select *Cont at Interrupt*
Frequency scan continues at the position where it was interrupted with the settings defined in the scan data set.
- ▶ If the receiver frequency is lower than that at which the scan was stopped, the frequency scan continues at the position where the receiver is at the moment with the settings defined in the scan data set when selecting *Cont at Rec Freq*. If the frequency is higher, the scan is started at the frequency at which it was interrupted. Thus part of the frequency scan can be repeated, if there has been any irregularity. The measured values already stored are deleted and replaced by the new ones. If the results are simultaneously output via plotter, the old measured values are overwritten.
- ▶ If the scan was interrupted and the RUN/STOP key is pressed, frequency scan is stopped. The data already measured get lost. The measurement can only be started from the beginning by activating again the RUN/STOP key.
At the intersection of transducer set ranges it is requested to change transducer by the following menu:

```

DATA INPUT
-----
SCAN
Interrupted..
connect TRD:<Name>
> Continue

```

- ▶ After having changed the transducer, frequency scan continues when a key in the ENTER area is pressed.

Note: *If an active transducer factor or set is not defined over the whole range of the scan, invalid measured values result in the range where the transducer is not defined. To inform the user about it the following error message is output on the DATA INPUT display:*

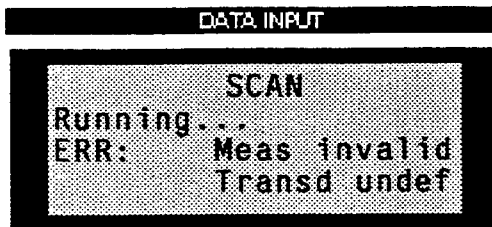

Valid measurements are carried out only at the frequencies where a valid transducer is defined.

After termination of the frequency scan a beeping tone is output, if the beeper is activated and the hint *Complete* appears in the DATA INPUT display.

3.2.4.4 Generating a Test Report (Report Keypad)

The result of a measurement run can be output both on a printer with Centronics interface and via IEC bus on a plotter with HP-GL interface. Any 24-pin printer, which is EPSON-compatible, may be used. The contents of the plotter or printer output can be determined by the user himself.

The following outputs are feasible:

- Measured value diagram with limit lines,
- Measurement settings of the receiver,
- Measurement curves,
- User-definable heading,
- Measuring value table and
- Date and time.

Thus it is possible to e.g. output the diagram on plotter and simultaneously the measured value table on printer. Plotting can also be carried out during the frequency scan (cf. section 3.2.4.3.3).

Page 3.71, Section 3.2.4.4 Generating a Test Report (Report Keypad)

In addition to final results of an RF analysis scan, the results of a prescan can be copied in tabular form to a printer. The parameter *Scan Res List* in the *Printer Setting* menu has to be switched ON. If a limit line is active and a margin was defined, only those values which exceed the limit and margin during a scan are printed out.

The menu for setting the printer is displayed in the following manner:

DATA INPUT	
PRINTER SETTING	
> Default	ON
Scan Res List	OFF
Final Results	ON
Title	ON
Scan Table	ON
Diagram	OFF

displayed after having pressed REPORT SETTING key

↑
↓
can be scrolled using ↑ and ↓ keys



3.2.4.4.1 Selecting the Pre-setting of the Printer and Plotter

The user himself can largely determine the test report by selecting the presetting of the printer or plotter. He can select the level display range by entering the minimum level (*Min Lev*) and maximum level (*Max Lev*) when defining the scan parameters (cf. section 3.2.4.3.1). In addition the user can select between linear (*Lin*) and logarithmic (*Log*) scaling of the frequency axis. He can also specify what is to be part of the test report. When using the plotter for output, the colors for the individual components of the display can be chosen differently to provide for a more easy-to-understand plot.

The presettings are stored in the memory with battery back-up so that usually the settings must be effected only once. They are even maintained after having called the default setting of the ESVD with the help of RCL 0 (cf. section 3.2.4.5).

Operation:

The menus for determining the design of the measured value output and presettings of the printer or plotter are called using the SETTING key in the keypad REPORT. In the first menu (REPORT SETTING) the user can select between presetting of the plotter or printer. In addition the scaling of the frequency axis can be specified in this menu.

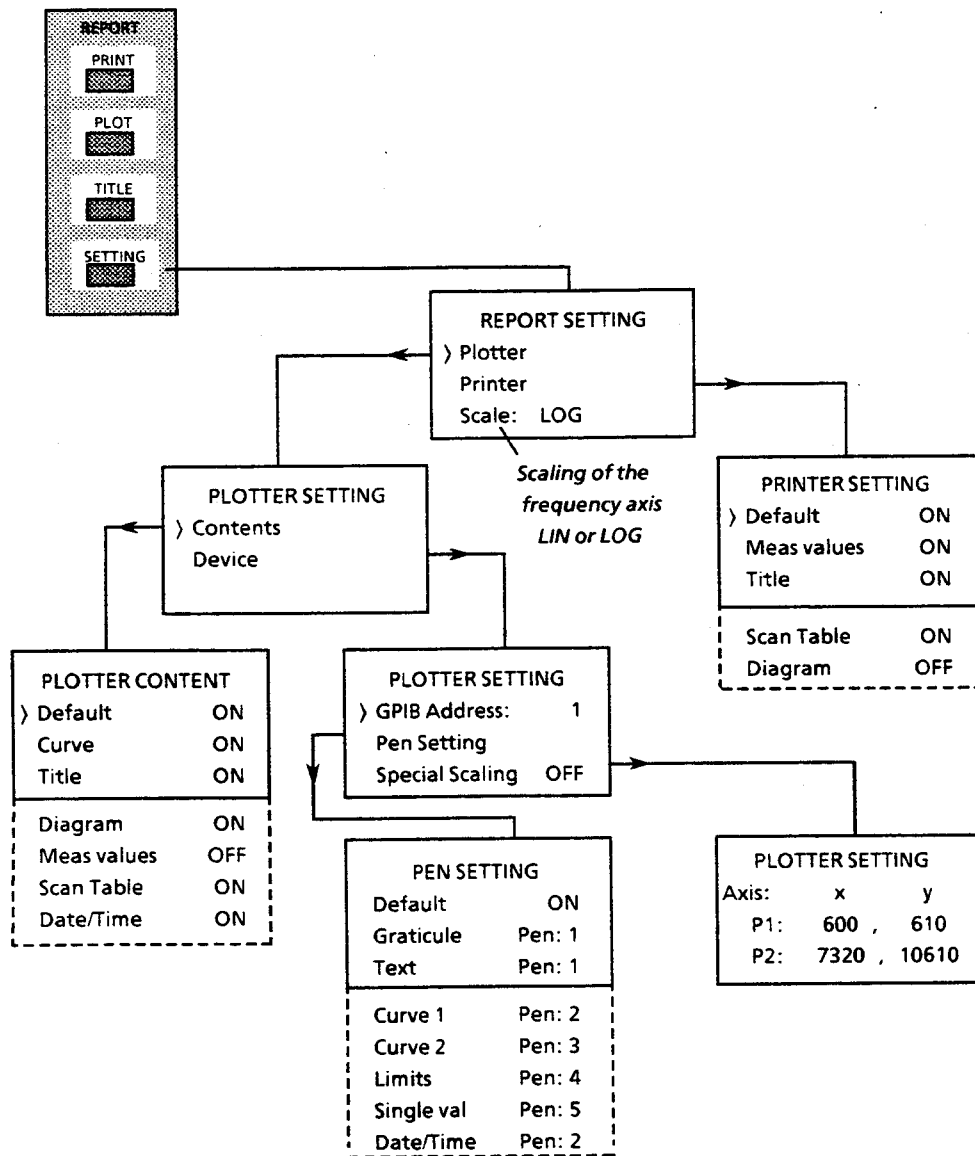

Fig. 3-22 Presettings for plotter or printer output

Scaling the Diagram: Linear or logarithmic scaling can be chosen for the frequency axis. Default setting is logarithmic scaling. If the ratio between maximum and minimum frequency is, however, lower than 1.5, the measured value diagram is automatically output with linear frequency scaling.

The scaling can be switched over using the ENTER key, when the cursor is placed on scale (LOG ↔ LIN).

Presetting of the Plotter: In the menu *PLOTTER SETTING* a distinction is made between contents (*Contents*) of the report and device setting (*Device*) of the plotter.

Contents In the menu *PLOTTER CONTENTS* the various components of a plot can be activated or deactivated. These are

- the graticule with frequency and level labelling and, if defined, the limit lines (*Diagram*),
- the heading defined by the user (*Title*, cf. section 3.2.4.1.2),
- the measured value curve(s) (*Curve*),
- the table with measured values (*Meas values*),
- the table with the list of scan and partial scan settings used with the appertaining receiver parameters (*Scan Table*) and
- date and time

Default setting (cf. fig. 3-22) is output with graticule including labelling, heading, date/time and test curves. The measured value table is not part of the default setting as it can be output more conveniently and quicker on a printer.

Device *DEVICE SETTING* is used to set the GPIB-address of the plotter, to assign the pens of the plotter to the graticule, labelling, test curves, limit lines and the measured values and to set the scaling of the test report. Values between 0 and 30 can be entered for the IEC-bus address. Other inputs are not accepted, i.e. the original value is maintained.

Pen Setting A submenu in which the individual plotter pens can be assigned to the various components of the test report is called using the menu point *Pen Setting*. With default setting (Default ON) the pens are selected as shown in fig. 3-22. When selecting a different pen assignment, default changes to OFF. Figures from 0 to 8 are permissible for the pen number. Other inputs are ignored, i.e. the former value is kept. Entering the figure 0 means that no pen is selected.

Special Scaling If another type of scaling of the test report than that specified by the plotter used is desired, the bottom left (P1) and the upper right (P2) corner of the report can be set separately with the help of the menu point "*Special Scaling*". When activating this menu point a submenu is called in which the values selected for P1 and P2 are entered. Values ranging from - 32768 to (+) 32767 are permissible for the coordinates. Illegal values are not accepted. The values for the coordinates depend on the plotter used and must be learnt from the manual of the plotter. The ESVD is preset for the use of the R&S-plotter DOP (cf. fig. 3-22). After having ended the input the status of *Special Scaling* changes to "ON".

Presetting of the Printer: The menu for setting the printer (PRINTER SETTING) offers the selection between the various elements of a report similarly as with plotter output (see above). Default setting means output of the title with measured value table and output of the scan settings (cf. fig. 3-22).

3.2.4.4.2 Input of the Labellings for Printer or Plotter Output

To provide complete documentation of the measurement results the printer or plotter report can be labelled individually. The following entries can be made:

- *Heading,*
- *Measurement Type,*
- *Equipment u. Test,*
- *Manufacturer,*
- *Operating Condition,*
- *Operator,*
- *Test Specification and*
- *Comment 1 and Comment 2 (two lines for comments).*

Operation:

The menu *TITLE*, in which the elements possible to label are stated, is called using the TITLE key in the keypad REPORT. The desired point is selected using the cursors. The following input menu varies depending on the instrument equipment available. If an external keyboard is connected, the desired text can be input using the same. Otherwise input can be made via the auxiliary line editor in the last two lines of the menu (operation cf. section 3.2.4.1.2).

In both cases 40 characters are maximally possible for each labelling element. Two lines with 60 characters each are permissible for the comment. Additional characters are not accepted.

The following menu tree shows the input of the labelling e.g. in the case of the title:

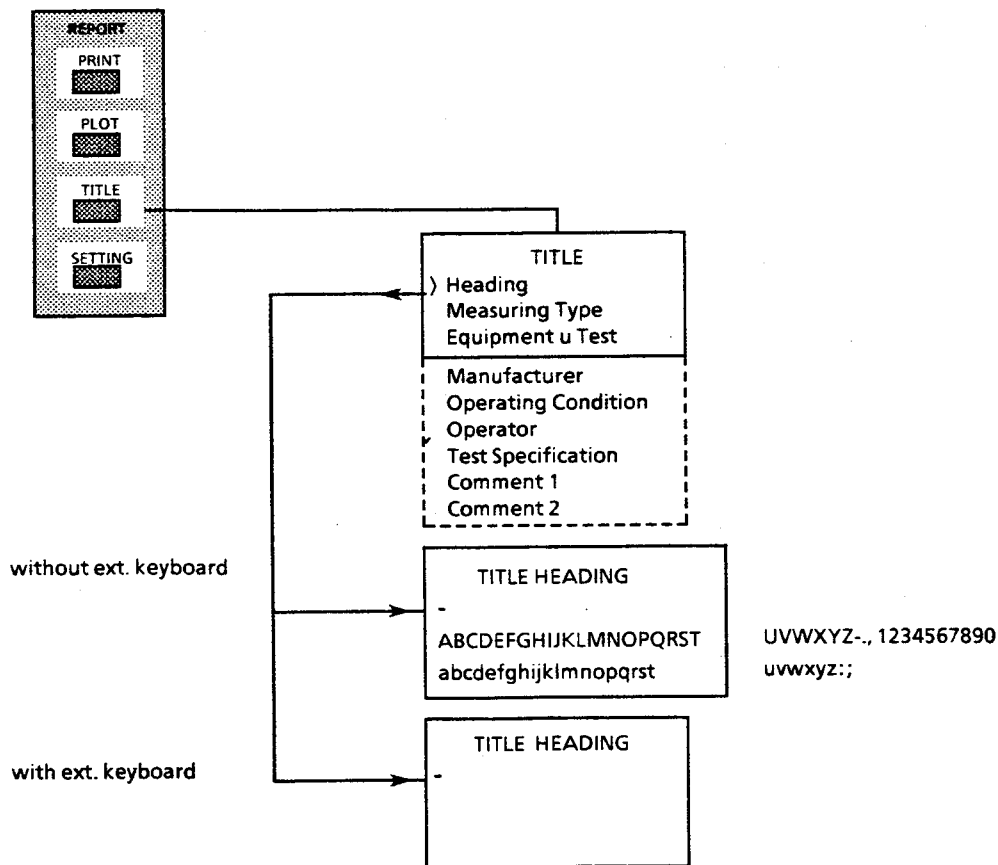

Fig. 3-23 Menu tree for input of the labelling

3.2.4.4.3 Output of the Measurement Results on Printer

When pressing the PRINT key the printer connected immediately starts to print the measurement results in the form they are configured in the *SETTING* and *TITLE* menus. If no printer is connected or it is not ready for operation, the message "Connect Printer!" is read out on the DATA INPUT display. After having connected a printer the printing process must be started again.

Printing is a background process, i.e. the receiver can be operated during printing. However, fast measurements take somewhat more time.

Printing can be stopped at any time using *Abort Printing*. In this case printing must be re-started for a further printout.

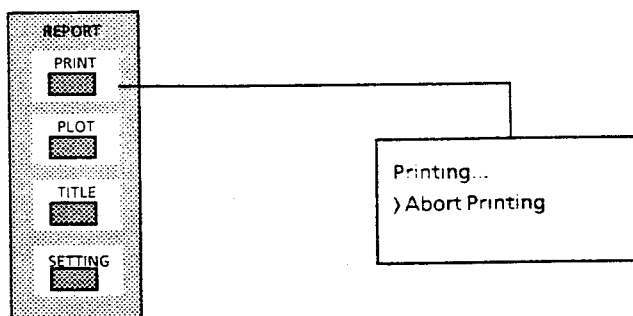

Fig. 3-24 Start of printer output

3.2.4.4.4 Output of the Measurement Results on Plotter

When pressing the PLOT key the plotter connected immediately starts to plot the measurement results in the form they are configured in the SETTING and TITLE menus. If no plotter is connected or the plotter connected has a GPIB-address different from that entered in SETTING, the message "Connect Plotter!" appears on the DATA INPUT display. After having connected a plotter or changed the address, plotting must be initiated again.

No other controller may be connected to the bus upon start of the plotter output, since otherwise the ESVD cannot adopt control of the IEC-bus (message on DATA INPUT display: "Bus Control required"). In such a case the controller must be disconnected from the IEC bus or pass control to the ESVD.

With the IEC bus out of operation (Spec Func 11, cf. section 3.2.3.13), start of plotter output is acknowledged by the message "IEC Bus OFF LSF 11". After the IEC bus has been switched on, the plotting procedure must be started again.

Pressing the PLOT key again when the plotting procedure has not yet been terminated causes the message: "WARN: Plotter active" to be read out in the DATA INPUT display. This message also appears when the plotter output is started and another plotting procedure which was initiated with option 62 (Meas&Plot) has not yet terminated.

The message WARN: No Pen selected indicates that an element of the measurement report, for which no pen was selected (Pen = 0 in PEN SETTING), will be outputted.

Plotting is a background process, i.e. the receiver can be operated during the plotting process. However, fast measurements take somewhat more time.

If output of a measured value diagram and of a table is specified, the former is plotted on the first page and the table on the following pages. The user is requested to change the sheet on plotter by the following message in the DATA INPUT display.

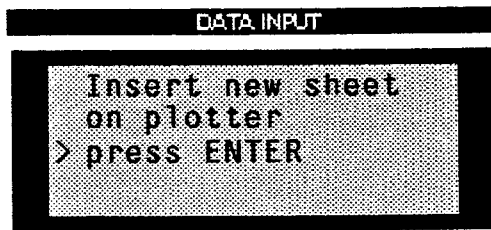

Labelling is repeated on every page.

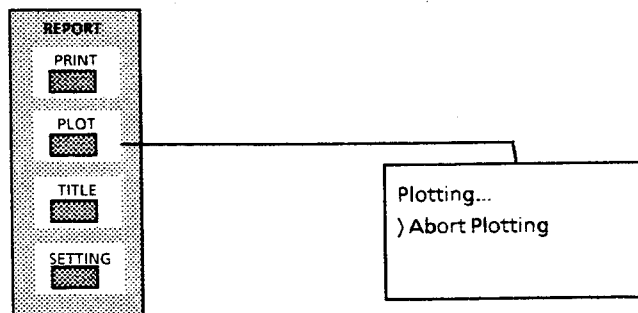

Fig. 3-25 Start of plotter output

Plotting can be stopped at any time using *Abort Plotting*. In this case plotting must be re-started, i.e. the plotting process cannot continue where it was aborted.



ROHDE & SCHWARZ RFI POWER

24. Apr 91 05:13:33

EUT: Computer
 Manuf: Black & White
 Operator: Wolf
 Test Spec: EN55014-A2
 Comment: Operation without filter

Scan Settings (i Range):

Frequencies				Receiver Setting				
Start	Stop	Step	IF BW	Detector	M-Time	Atten	Preamp	OpRge
30M	300M	50k	120k	PK + AV	1ms	AUTO LN	OFF	60 dB

Final Measurement: * QP + AV
 Meas Time: 1 s
 Subranges: 25
 Acc Margin: 10 dB

Transducer No: 1
 Start/MHz: 25.000
 Stop/MHz: 1000.000
 Name: MDS

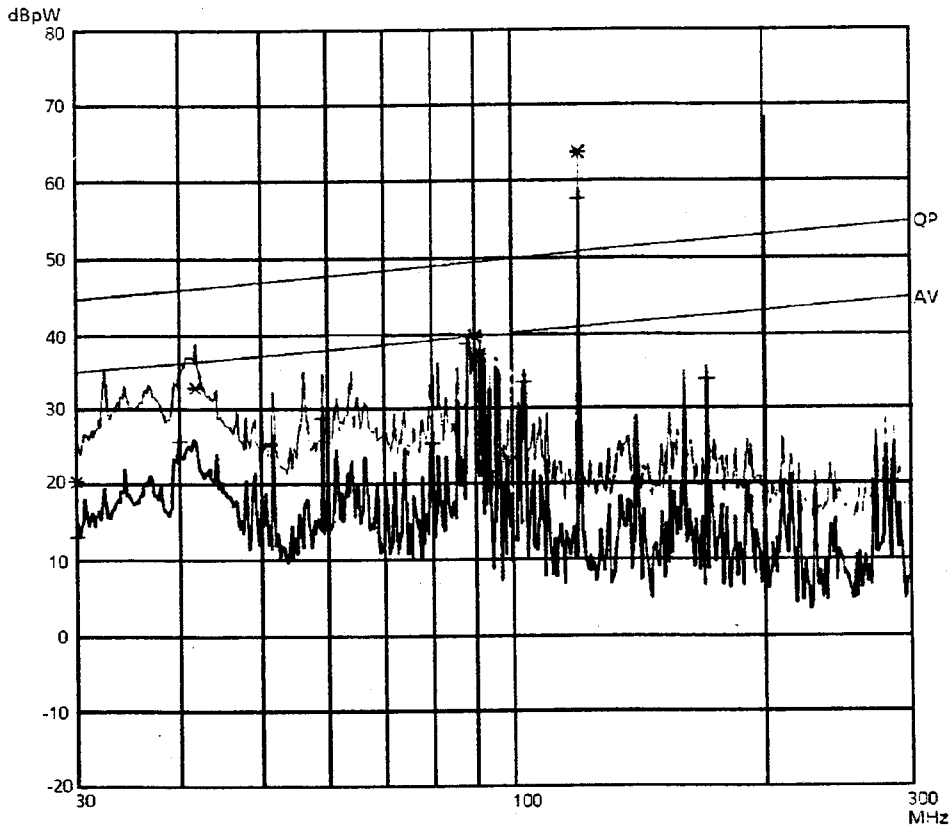

Fig. 3-26 Plotter output

3.2.4.5 Saving and Calling the Receiver Configuration

In the ESVD, 9 complete instrument settings (1 to 9) maximally can be saved. The setting 0 contains the default setting of the receiver and cannot be modified. All the settings are set to their default values using 0. The settings are stored in the internal CMOS-RAM and are thus maintained even after having switched off the instrument. The settings for measurements that are performed repeatedly must only be entered once and can be re-called at any time.

The following parameters are saved:

- All the current receiver settings, such as frequency, attenuation, operating range, detector, etc.
- the special functions activated,
- the transducer settings currently effective,
- the limit lines,
- the scan data set and
- the set scan options.

To facilitate the recovery of settings saved, they can be provided with a name.

Note: As the limit lines and the transducer in turn contain extensive data sets, they are saved completely only once. The data set stored only contains a hint as to the respective limits and transducers. If the latter are changed subsequently, it may occur that the initial transducer or limit cannot be reconstructed any more when re-calling an instrument setting.

Operation:

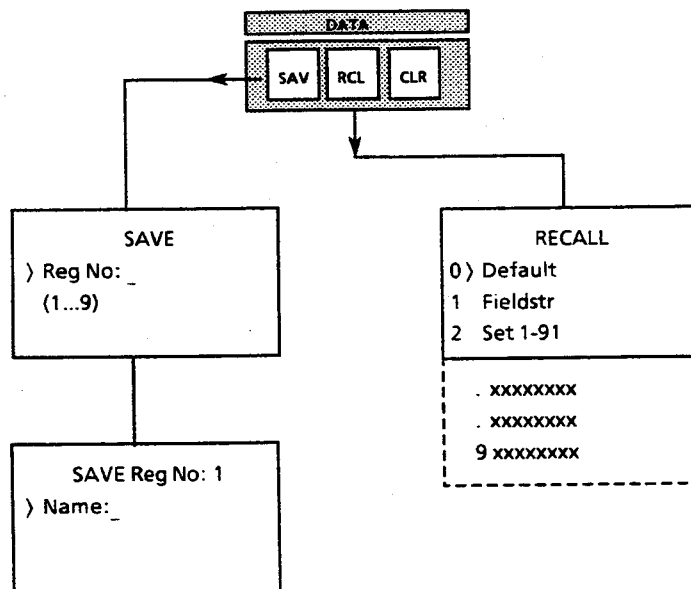

Fig. 3-27

Saving a Device Configuration:

The desired register is requested in the DATA INPUT display when pressing the SAV key in the DATA keypad. The permissible registers (1 to 9) are also shown in the display. If the register is already occupied, its contents are overwritten with the new data set. After having entered the respective number (<number> + ENTER) a further menu appears, in which a name for the register selected can be entered. After having input the name the currently effective configuration is saved.

Recalling a Device Configuration:

The key RCL in the DATA keypad serves to call a menu in the DATA INPUT display in which all the occupied registers together with their number and name are represented in the form of a list. The desired register can be called either by entering the corresponding number or selecting it with the help of the cursor. It is not possible to call registers not occupied. In this case the receiver outputs the error message "ERR: Reg empty".

Default setting of the ESVD (RCL 0):

Frequency:	100 MHz
Step size:	COARSE
Attenuation:	AUTO, LOW NOISE (RF attenuation \geq 10 dB)
Detector:	AV
IF bandwidth:	120 kHz
Operating range:	60 dB
Measuring time:	100 ms
Pre-amplifier:	off
Special functions:	Default setting (cf. 3.2.3.13)
Setup:	is not affected
Transducer:	all the transducers defined are deactivated
Limit lines:	all the limit lines defined are deactivated
Options:	none
Scan data set:	Default data set (cf. 3.2.4.3.1)
Printer/Plotter settings:	are not affected

3.2.5 Connecting External Devices

3.2.5.1 Connecting the Transducers (ANTENNA CODE)

The ANTENNA CODE socket is provided for the supply and coding of the conversion factors of transducers. It serves to code the conversion factors of current probes and antennas in 10-dB steps. In addition the receiver is informed on the quantity to be measured (fieldstrength, current and voltage). Active transducers can be supplied with ± 10 V by the socket.

The following R&S-accessories are available with suitable coding:

- RF current probe 20 Hz ... 100 MHz EZ-17
- VHF current probe 20 ... 30 MHz ESV-Z1
- Broadband dipole 20 ... 80 MHz HUF-Z1
- Preamplifier 20 ... 1000 MHz ESV-Z3

It is, however, recommended to enter the exact conversion factor via the transducer factors to achieve higher measurement accuracy (cf. section 3.2.4.2.2).

The coding can be rendered ineffective using the special function SPEC FUNC 12. This is useful if with an active transducer the supply is to be used, however the coding is not desired. If a transducer is used during the measurement, the coding at the ANTENNA CODE socket is automatically rendered ineffective.

For fieldstrength measurements in shielded rooms, if the ESVD is operated outside the room, the shield of the supply and coding cable must be fed through the screen of the room, such that there is no emitted interference inside the room. The ANTENNA CODE socket is assigned as follows:

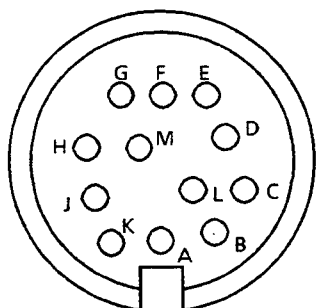

- A ground
- B + 10 V, max. 50 mA
- C $\mu\text{V}/\text{m}$ (electr. fieldstr.)
- D μA
- E 10 dB
- F 20 dB
- G 40 dB
- H 80 dB
- K - 10 V, max. 50 mA
- M - Reversing the sign of the factor

Fig. 3-28 Assignment of the 12-contact Tuchel-type female connector

A 12-contact connector (Tuchel-type, R&S-order number 0018.5362.00) is used for coding. The inputs for the code must be connected to ground.

Example: An antenna for electric fieldstrength measurements has an antenna factor of 10 dB, i.e. a fieldstrength of $10 \text{ dB}\mu\text{V}/\text{m}$ produces a voltage of 0 dB μV at the RF input.

► The pins C and E must be connected to ground.

3.2.5.2 AF Output

An external loudspeaker, headphones or, e.g., an AF voltmeter can be connected to the AF OUTPUT socket using a PL-55-connector. The internal resistance is 10Ω , output power is higher than 100 mW. If a connector is connected, the internal loudspeaker is automatically switched off.

3.2.6 Inputs and Outputs at the Rear Panel

3.2.6.1 IF Output 74.7 MHz (74.7 MHz OUTPUT)

The 74.7 MHz OUTPUT is provided for the connection of a panorama monitor or a spectrum analyzer. The gain compared to the RF input is 10 dB (with pre-amplifier 20 dB), if RF attenuation is 0 dB. The 3-dB bandwidth is larger than 2 MHz. It is however determined by the RF bandwidth at low frequencies and at the limits of the pre-selection filters (cf. Specifications).

3.2.6.2 IF Output 10.7 MHz (10.7 MHz OUTPUT)

The 10.7-kHz output is suitable for tests with oscilloscope, spectral analysis and examination of the modulation. The bandwidth is equal to the IF bandwidth selected.

The output voltage (EMC) is 1 mV to 1 V in the 60-dB range
 and 1 mV to 30 mV in the 30-dB range.

3.2.6.3 Video Output

The signal of the envelope demodulator is brought out at the video output. The voltage is identical to the envelope of the IF signal and is therefore suitable for examinations with the oscilloscope. The output voltage is 0 to 4 V; the internal resistance is 50 Ω ; it can however only be loaded with high impedances ($> 1 \text{ k}\Omega$). The bandwidth corresponds to the IF bandwidth set.

3.2.6.4 Reference Output (10 MHz REF OUTPUT)

The 10 MHz REF OUTPUT (item 32, fig. 3-2) serves for synchronization of the external devices. It supplies a 10-MHz signal with a level of $> 7 \text{ dB}$ into 50 Ω . Frequency accuracy is identical with that of the internal oven-controlled crystal oscillator.

The output level is available both with switched-on instrument and in standby mode (mains-connected, ON/OFF switch set to ON).

3.2.6.5 I/Q Outputs (I OUTPUT and Q OUTPUT) (only available with ESVD-B1 option)

The most common type of demodulation is shifting the RF signal to baseband. The real, band-limited signal in RF position is converted to a complex signal in baseband position. The real part of the signal is the so-called in-phase component (I signal), the imaginary part is the quadrature component (Q signal). The RF signal can be restored completely from these two components in magnitude $|A|$ and phase ϕ using the following formulas:

$$|A| = \sqrt{I^2 + Q^2} \text{ and}$$

$$\phi = \arctan \left(\frac{Q}{I} \right)$$

They allow to demodulate any types of modulation such as AM, FM, ϕ M but also all the other digital kinds of modulations of an RF signal. The I signal and the Q signal are usually appropriately digitized for further demodulation and subsequently processed by a digital signal processor using an algorithm suitable for the used type of modulation.

Since both sampling rate and processing algorithm for each type of modulation must be matched to the modulation currently used in order to ensure effective further processing, the ESVD provides the universal outputs for the in-phase- and quadrature components. The signal voltage at both outputs is controlled and adjusted to the peak value of 3 V, thus being suitable for all commercially available A/D converters. The control has a rise time of approx. 100 μs and a hold-time constant of about 200 ms, respectively, thus ensuring that the amplitude remains constant during a transfer burst in the case of transfer methods with time multiplexing, such as in GSM and PCN. The internal impedance of both outputs is 50 Ω . They can be loaded with 200 Ω without any additional amplitude or phase distortions occurring.

Both the phase error with typ. 0.7° and amplitude error between I and Q output with typ. 0.2 dB are very minor. Dynamic phase error with the 300-kHz IF bandwidth according to GSM Rec. 5.04 including phase distortion by the IF filter is lower than 3°. The 3-dB bandwidth of the I/Q demodulator is 200 kHz or half the 3-dB bandwidth of the IF filter with the lower value being decisive.

3.2.6.6 USER INTERFACE

The USER INTERFACE at the rear panel of the ESVD is a 25-contact CANNON-socket, to which five different signal groups are assigned. It contains the following interfaces:

- Serial Interface (RS232-C) for loading the firmware,
- Internal serial bus for control of accessories,
- 6 parallel TTL-control lines (port 1 to port 6),
- +5-V- and +12-V-voltage for supply of external devices and
- analog outputs for the display voltage.

The pin assignment is shown in the following figure:

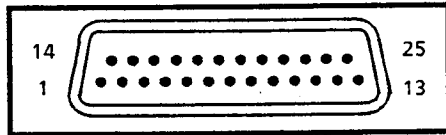

Pin	Signal	I/O	Meaning
1	EXTRIG	I	Ext. trigger, switchable pos./neg. trigger
2	RxD	I	Received Data: transmits ASCII data from computer to receiver
3	TxD	O	Transmitted Data: transmits ASCII data to the computer
4	DSR	I	Data Set Ready
5	DTR	O	Data Terminal Ready
6	RTS	O	Request To Send
7	AGND		Analog Ground
8	DCD	I	Carrier Detect
9	SCLK	O	Clock for Serial Bus (Clock Rate 4 MHz)
10	TDATA	O	Data line for serial bus
11	REC2	O	Recorder Output with Artificial Instrument
12	DGND		Digital Ground
13	+5 V		Supply for external accessory, $I_{max} = 0.1 A$
14	PORT1	O	User Port Data 1
15	PORT2	O	User Port Data 2
16	PORT3	O	User Port Data 3
17	PORT4	O	User Port Data 4
18	PORT5	O	User Port Data 5
19	PORT6	O	User Port Data 6
20	CTS	O	Clear To Send
21	Strobe	O	Control signal for transfer of data to register
22	RI	I	Ring indicator
23	REC1	O	Recorder Output without Artificial Instrument
24	AGND		Analog ground
25	+12 V	O	Supply voltage for accessories, $I_{max} = 0.1 A$

Fig. 3-29 Assignment of the user interface X 37 (USER INTERFACE)

3.2.6.6.1 Serial Interface (RS-232 C)

The serial RS-232-C-interface is provided for loading the instrument firmware. It allows the loading of new firmware versions using personal computer compatible with IBM-AT via its serial interface without opening the instrument. For more details refer to section 4.

The connection to the PC is established via a cable with a 25-contact connector (to the ESVD) and a 9-contact connector (to the PC), which is included in the ESVD-service kit (cf. Specifications, Recommended Accessories). It is also possible to use an adaptor from 25-contact to 9-contact that is commercially available, as the pin assignment of the ESVD is in accordance with the standard. The following table contains the pin assignment of the serial RS-232C-interface:

Table 3-11

Pin	Signal	I/O	Meaning
2	RxD	I	Received Data: transmits ASCII data from the computer to the receiver
3	TxD	O	Transmitted Data: transmits ASCII data to the computer
4	$\overline{\text{DSR}}$	I	Data Set Ready
5	$\overline{\text{DTR}}$	O	Data Terminal Ready
6	$\overline{\text{RTS}}$	O	Request To Send:
8	DCD	I	Carrier Detect
20	CTS	O	Clear To Send

3.2.6.6.2 Serial Bus (Currently not used)

The device-internal bus, which is also used for control of the modules of the instrument, is brought out for control of accessories. The bus has a high impedance when it is not selected (tri-state output). The word length is a multiple of 8 bit (= 1 byte). The address of the device to be controlled is transmitted as the last byte.

Table 3-12

Pin	Signal	I/O	Meaning
9	SCLK	O	Clock for serial bus (Clock rate 4 MHz)
10	TDATA	O	Data line of serial bus (4 MHz)
12	DGND		Digital Ground
21	$\overline{\text{Strobe}}$	O	Control signal for transfer of data to a register (Active Low)

3.2.6.6.3 TTL-I/O-Lines

Six port lines are provided for the control of external devices. Thus the phases and the reference ground are switched over. The level corresponds to that of the TTL-logic (low < 0.4 V, high > 2.0 V).

Table 3-13

Pin	Signal	I/O	Meaning
12	DGND		Digital Ground
14	PORT 1	O	User Port Data 1
15	PORT 2	O	User Port Data 2
16	PORT 3	O	User Port Data 3
17	PORT 4	O	User Port Data 4
18	PORT 5	O	User Port Data 5
19	PORT 6	O	User Port Data 6

3.2.6.6.4 Trigger Input

The trigger input (USER PORT, pin 1) allows to start measurements depending on an external event. This input is activated using the special functions 51 and 52 (cf. section 3.2.3.13). The input is triggered by edges and requires TTL-level (low < 0.4 V, high > 2.0 V).

3.2.6.6.5 Analog Voltages

There are two outputs (REC1 and REC2) available for logging the analog display voltage using a YT-recorder or for observing the shape of the display voltage using an oscilloscope. Both outputs provide the analog display voltage. The output REC2 contains a low-pass with the time constant 100 ms, which corresponds to the meter time constant according to CISPR 16. The outputs provide a voltage which is dB-linear and feature the scaling 50 mV/dB in the 60-dB operating range and 100 mV/dB in the 30-dB operating range. Full scale deflection on the display instrument corresponds to a voltage of 3.75 V at the analog outputs (pin assignment cf. figure 3-29).

3.2.6.6.6 Supply voltages

For supplying external devices with low current consumption, the device-internal supply voltages +5 V (5.0 V to 5.5 V) and +12 V (10.8 to 15 V) are brought out. The current-carrying capacity is 100 mA for both outputs. The receiver automatically switches off in the case of a short-circuit.

Table 3-14

Pin	Signal	Meaning
13	+5V	5-V supply
24	AGND	Analog ground
25	+12V	12-V supply

3.2.6.7 Printer Interface

The 15-contact socket PRINTER INTERFACE at the rear panel of the receiver is provided for connecting a printer. The interface is compatible with the CENTRONICS-interface. A special cable can be supplied for connecting the interface to the printer (EZ11-type, cf. Specifications, Recommended Accessories):

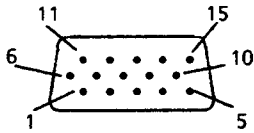

Pin	Signal	I/O	Meaning
1	$\overline{\text{PRISTB}}$	O	Pulse for transmitting a data byte
2	PRIDAT2	O	Data line 2
3	PRIDAT5	O	Data line 5
4	$\overline{\text{PRIACK}}$	I	Indicates that the printer is ready for reception of the next byte
5	PRISEL	I	The printer supplies HIGH, when it is selected
6	PRIDAT0	O	Data line 0
7	PRIDAT3	O	Data line 3
8	PRIDAT6	O	Data line 6
9	$\overline{\text{PRIBUSY}}$	I	Signal HIGH, when the printer is busy
10	PRIRES	O	Initialization of the printer (active LOW)
11	PRIDAT1	O	Data line 1
12	PRIDAT4	O	Data line 4
13	PRIDAT7	O	Data line 7
14	AGND		Analog Ground
15	$\overline{\text{PRIFAU}}$	I	Fault of printer (active Low)

Bild 3-30 Pin assignment of the Printer Interface

3.2.6.8 IEC-Bus

The ESVD is equipped with a remote control interface according to the standard IEC 625. It is connected to the socket at the rear panel of the instrument.

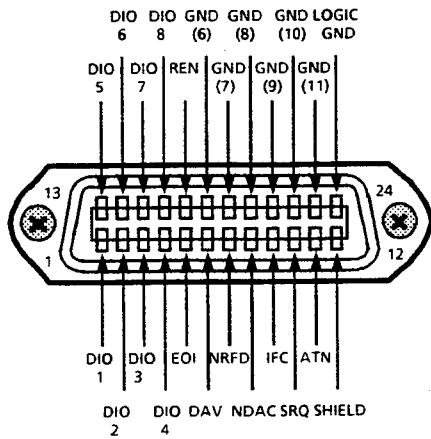

Pin	Signal	Pin	Signal
1	Data I/O1	13	Data I/O5
2	Data I/O2	14	Data I/O6
3	Data I/O3	15	Data I/O7
4	Data I/O4	16	Data I/O8
5	EOI	17	REN
6	DAV	18	Ground
7	NRFD	19	Ground
8	NDAC	20	Ground
9	IFC	21	Ground
10	SRQ	22	Ground
11	ATN	23	Ground
12	Shield	24	Logic Ground

Fig. 3-31 Pin assignment of the IEC-bus socket

The characteristics of the interface can be learnt from the IEC-standard. The interface functions and setting commands are described in section 3.3.

Note: *In order to achieve a long operating time per battery charge, the IEC-bus interface is switched off during operation with internal battery. If remote control via IEC-bus is desired with battery operation, it can be switched on using the Special Function 11 (cf. section 3.2.3.13).*

3.2.6.9 Connecting a Keyboard

A 5-contact DIN*-socket is provided for connecting a keyboard. Due to its low emitted interference it is recommended to use the keyboard PSA-Z1 (order no. 1009.5001.32). It is however also possible to use any other MF-compatible keyboard.

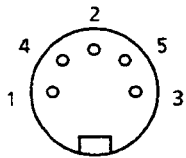

Pin	Signal
1	Keyboard Clock
2	Data
3	free
4	ground
5	+ 5-V supply

Fig. 3-32 Assignment of the KEYBOARD socket

*) German Industrial Standard

3.3 Remote Control (IEC-Bus)

The test receiver ESVD features an IEC-bus device as standard equipment. The interface complies with the standards IEEE 488.1 and IEC 625-1. The ESVD furthermore considers the standard "IEEE Standard Codes, Formats, Protocols, and Common Commands ANSI/IEEE Std 488.2 - 1987" also approved of by the IEC commission. The standard IEEE 488.2 describes common commands, data transfer formats, terminator definitions, protocols of passing control.

Program examples in R&S-BASIC can be found in section 3.5.

The IEC-bus connection socket is situated on the rear panel of the ESVD. It is a 24-contact Amphenol connector complying with the IEEE 488 standard (cf. section 3.2.6.7). The interface contains three groups of bus lines:

1. Data bus with the 8 lines DIO1 to DIO8

Data transmission is bit-parallel and byte-serial with the characters in ISO 7-bit code (ASCII-code), cf. table 3-18.

2. Control bus with 5 lines

ATN (Attention)

becomes active Low when addresses, universal commands or addressed commands are transmitted to the connected devices.

REN (Remote Enable)

enables the device to be switched to the remote status.

SRQ (Service Request)

enables a connected device to send a Service Request to the controller by activating this line.

IFC (Interface Clear)

can be activated by the controller in order to set the IEC interfaces of the connected devices to a defined status.

EOI (End or Identify)

can be used to identify the end of data transfer and is used with a parallel poll.

3. Handshake bus with 3 lines

It is used to control the data transfer timing via the IEC-bus.

NRFD (Not Ready For Data)

an active Low on this line signals to the talker/controller that at least one of the connected devices is not ready to accept data present on the data bus.

DAV (Data Valid)

is activated by the talker/controller shortly after a new data byte has been applied to the bus and signals that this data byte is valid.

NDAC (Not Data Accepted)

is held at active Low until the connected devices have accepted the data byte present on the bus.

According to the IEC 625-1 standard, devices controlled via the IEC bus can be equipped with different interface functions. The following interface functions are applicable to the ESVD:

Table 3-17 Interface functions

Control characters	Interface functions
SH1	Source Handshake function, full capability
AH1	Acceptor Handshake, full capability
L4	Listener function, full capability, unaddress if MTA
T6	Talker function, full capability, unaddress if MLA
SR 1	Service Request function, full capability
PP1	Parallel Poll function, full capability
RL1	Remote/Local switchover function, full capability
DC1	Device Clear function, full capability
DT1	Device Trigger function, full capability
C1 C2 C3 C11	Controller function, (system controller) transmits IFC transmits REN takes and passes control

3.3.1 Setting the Device Address

The IEC-bus address of the receiver is set in the SETUP menu (cf. section 3.2.4.2.1). The address can be entered using the numeric keys in the range from 0 to 30 and remains stored in the non-volatile memory when the test receiver is switched off. The ESVD is set to address 20 (upon delivery, cold start or firmware update).

The controller uses the IEC-bus address to address the ESVD as IEC-bus talker or -listener. "Talk Only" is not provided in the case of the ESVD.

3.3.2 Local / Remote Switchover

The ESVD is always in the "Local" state at turn-on (manual operation). If the ESVD is addressed as Listener by a controller (e.g. using the R&S-BASIC commands "IECOUT" or "IECLAD"), the test receiver enters the Remote state and remains in this state after data transfer has been completed. This is indicated by the "REMOTE" LED on the front panel.

Note: *If the ESVD is supplied by the internal battery, the IEC-bus is switched off following switch-on to reduce current consumption. The IEC-bus can be switched on at any time using special function 11.*

In this mode the receiver cannot be operated manually via the front panel. Rotary knob and keys (with the exception of the "LOCAL" key) are disabled, no menu is displayed. There are two methods to return to the LOCAL state:

- by the addressed command "Go To Local" (GTL) from the controller.
- by pressing the LOCAL key located on the front panel of the receiver. Data output from the controller to the ESVD should be stopped before pressing the LOCAL key, as otherwise the ESVD will immediately enter the Remote state again. The LOCAL key can be disabled by the universal command "Local Lockout" (LLO) sent by the controller in order to prevent undesired switchover to the "Local" state. Returning from the disabled state to manual operation is possible by way of the command GTL. However, the Local Lockout function is effective again when entering anew the

Remote state. Triggered by the controller the Remote Enable line (REN) renders the LLO function definitely ineffective. To this end the combination of the commands IECNREN and IECREN can be used in, for example, R&S-BASIC.

3.3.3 Interface Messages

This group of messages are transmitted to a device via the eight data lines by the controller where the ATN-line is active, i.e low. Only active controllers are able to transmit interface messages. Differentiation is made between universal commands and addressed commands.

3.3.3.1 Universal Commands

Universal commands act, without previous addressing, on all devices connected to the IEC-bus.

Table 3-18 Universal commands

Command	Basic command with R&S controllers	Function
DCL (Device Clear)	IECDCL	Aborts processing of the currently received commands and sets the command processing software to a defined initial status. This command does not affect the device settings
LLO (Local Lockout)	IECLLO	The LOCAL key is disabled.
SPE (Serial Poll Enable)	IECSPE	Ready for serial poll.
SPD (Serial Poll Disable)	IECSPD	End of serial poll.

3.3.3.2 Addressed Commands

The addressed commands act only on those devices previously addressed as listeners by the controller (e.g. R&S-BASIC command "IECLAD").

Table 3-19 Addressed commands

Command	Basic command with R&S controllers	Function
SDC (Selected Device Clear)	IECSDC	Aborts processing of the currently received commands and sets the command processing software to a defined initial status. This command does not affect the device settings.
GTL (Go to Local)	IECGTL	Change to Local state (manual operation)
GET (Group Execute Trigger)	IECGET	Start of level measurement

A device is addressed as listener until it is unaddressed by the controller (R&S-BASIC command: IECUNL).

Table 3-20 ASCII/ISO- and IEC-character set

Control characters					Numbers and special characters					Upper-case letters				Lower-case letters			
0	NUL		16	DLE		32	SP	48	0	64	@	80	P	96		112	p
1	SOH	GTL	17	DC1	LL0	33	!	49	1	65	A	81	Q	97	a	113	q
2	STX		18	DC2		34	"	50	2	66	B	82	R	98	b	114	r
3	ETX		19	DC3		35	#	51	3	67	C	83	S	99	c	115	s
4	EOT	SDC	20	DC4	DCL	36	\$	52	4	68	D	84	T	100	d	116	t
5	ENQ	PPC	21	NAK	PPU	37	%	53	5	69	E	85	U	101	e	117	u
6	ACK		22	SYN		38	&	54	6	70	F	86	V	102	f	118	v
7	BEL		23	ETB		39	'	55	7	71	G	87	W	103	g	119	w
8	BS	GET	24	CAN	SPE	40	(56	8	72	H	88	X	104	h	120	x
9	HT	TCT	25	EM	SPD	41)	57	9	73	I	89	Y	105	i	121	y
10	LF		26	SUB		42	*	58	:	74	J	90	Z	106	j	122	z
11	VT		27	ESC		43	+	59	;	75	K	91	[107	k	123	{
12	FF		28	FS		44	,	60	<	76	L	92	\	108	l	124	
13	CR		29	GS		45	-	61	=	77	M	93]	109	m	125	}
14	SO		30	RS		46	.	62	>	78	N	94	^	110	n	126	~
15	SI		31	US		47	/	63	? / UNL	79	O	95	-	111	o	127	DEL
Addressed commands			Universal commands			Listener addresses				Talker addresses				Secondary addresses and commands			

Code for control characters:

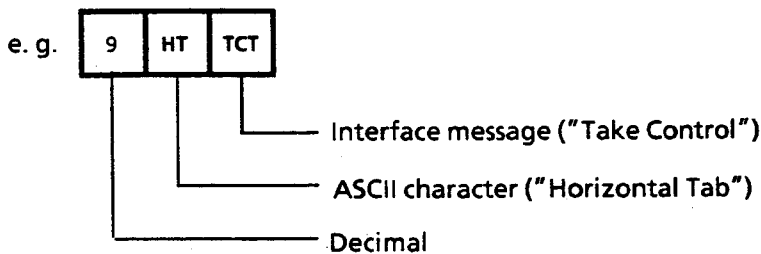

3.3.4 Device Messages

Device messages (acc. to IEC 625-1) are transmitted via data lines, in which case the ATN line is not active, i.e. High. The ASCII code (ISO 7-bit code) is used. A differentiation is made between:

- Device-independent commands (common commands acc. to IEC 625, cf. section 3.3.4.3)
- Device-specific commands (cf. section 3.3.4.4)

Commands with a "?", such as FREQUENCY? are referred to as "query messages" and request the ESVD to output the respective value where the same format is used as in the command table. The data and values read in by the controller can thus be directly returned to the ESVD. In this example the output of the test receiver may be "FREQUENCY 10000000" where the basic unit (here: Hz) is always valid.

3.3.4.1 Commands Received by the Test Receiver in Listener Mode (Controller to Device Messages)

Input buffer:

All the commands and data sent to the receiver are stored temporarily in the 4096-byte input buffer. It is however also possible to process longer command lines in which case the part received before is processed internally in the receiver.

Terminators:

Each command line must be ended by a terminator (exception: continued command lines). Permissible terminators are:

- <New Line> (ASCII-Code 10 decimal)
- <End> (EOI line active) together with the last character of the command line or the character <New Line>.

The terminator is set using the device-specific commands TERMINATOR LFEOI - <New Line> together with <EOI> - and TERMINATOR EOI - only <EOI> for transmission of binary data blocks (cf. section 3.3.4.4).

As the character <Carriage Return> (ASCII code 13 decimal) is permissible as a filler without effect before the terminator, the combination of <Carriage Return> and <New Line> that is for example sent by the R&S-Controller PCA is also permissible.

All IEC-bus controllers from Rohde & Schwarz send terminators accepted by the test receiver as standard. A command line may require more than one line on the controller screen since it is only limited by the terminator. Most IEC-bus controllers add automatically the terminator to the data transmitted.

Separators:

A command line may contain several commands (program message units) when separated from each other by a semicolon (;).

Command Syntax:

A command may consist of the following parts:

- Only a header
Example: *RST
- Combination of headers
Example: CALIBRATION:SHORT
- Header and question mark ("query")
Example: UNIT?

These commands request the test receiver to transfer the desired data to its output buffer. These data can be read in by the controller as soon as the device will be addressed as a talker.

- Header and numeric value
Examples: MEAS:TIME 50 MS
FREQUENCY 1.045E2

According to the IEC-bus standard IEEE 488.2, the header and numeric value must be separated at least by one space (ASCII code 32 decimal). In the case of device-specific commands, the number can be supplemented by a unit (e.g. "MHz", "S", etc.).

- Header and mnemonic
Example: DETECTOR AVERAGE
- Header and string
Example: LIMIT:TEXT 'VFG 1046'
or LIMIT:TEXT "VFG 1046"

The two different types of notation allow to use them in different programming languages without any difficulties. The character ' is preferably used in R&S-BASIC.

The headers and their meanings are explained in section 3.3.4.4. Lower-case letters are equivalent to upper-case letters. Thus units can be used in the usual form, e.g. dBm instead of the notation using upper-case letters "DBM".

The IEC-bus syntax makes it possible to insert additional spaces at the following points:

- at the beginning of a header
- between header and numeric value, mnemonic or string
- between numeric value and unit
- before and after commas (,) and semicolons (;)
- before the terminator.

Numeric values:

Only decimal numbers are allowed as numeric values, the following notations are permissible:

- With and without sign
Example: 10, +10, -10
- With and without decimal point, any position of the decimal point is permissible.
Example: 1.234 -200.5 .123

- With or without exponent to base 10, "E" or "e" can be used as the exponent character.
Example: 451 451E-3 +4.51e-2
- The exponent is permissible with or without a sign, a space is also permissible instead of the sign
Example: 1.5E+3 1.5e-3 1.5E 3
- Specification of the exponent only (e.g. E-3) is not permissible, 1E-3 is correct.
- Leading zeros are permissible in the mantissa and exponent.
Example: +0001.5 -03.7E-03
- The length of the numeric value, including the exponent, may be up to 20 characters. The number of digits for the mantissa and exponent is only limited by this condition. Digits that exceed the resolution of the device are rounded up or down; they are, however, always considered for the order of magnitude.

Command line

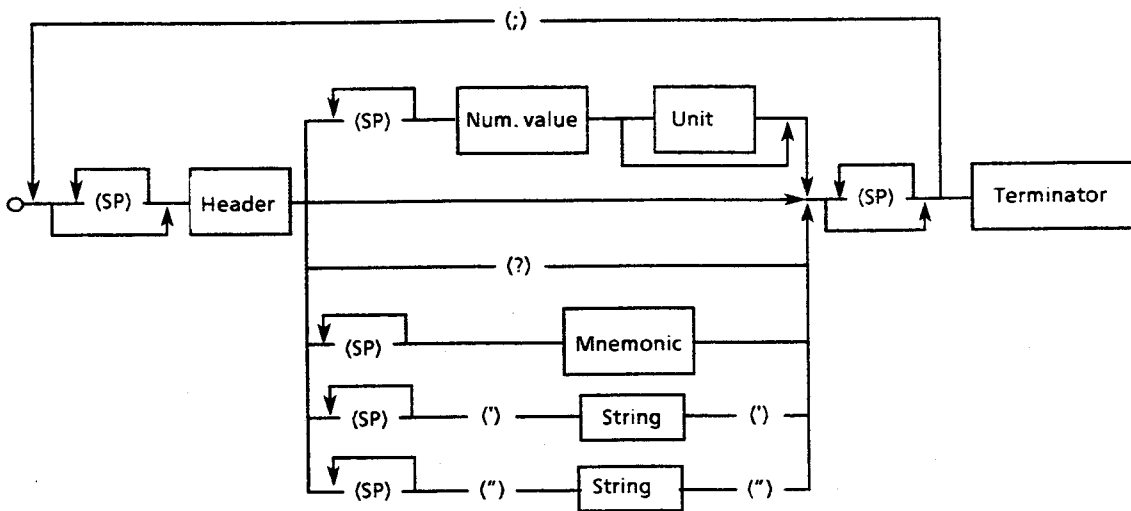

Numeric value

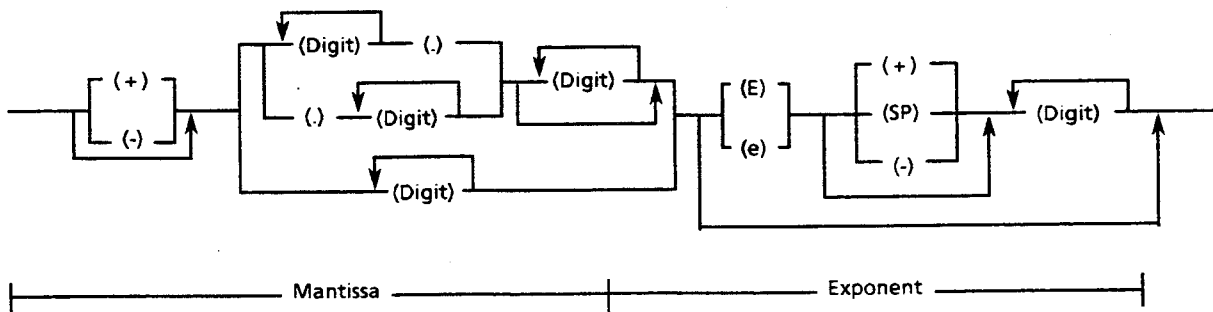

SP: Any character with ASCII code 0 to 9 and 11 to 32 decimal, especially space.

Fig. 3-34 Syntax diagram of a command line

3.3.4.2 Messages Sent by the Test Receiver in Talker Mode (Device to Controller Messages)

The ESVD sends messages via the IEC-bus, if it

- has been requested to make data available in its output buffer by one or more query messages with a question mark within one command line,
- indicates by setting bit 4 in the status byte (Message Available) that the requested data are now available in the output buffer,
- has been addressed as a talker (e.g. by the R&S-BASIC command "IECIN").

It is necessary for the command line with the data requests to be transmitted directly before talker addressing; if another command line is present in between, the output buffer is cleared and bit 2 in the event status register is set (query error; cf. section 3.3.5).

The output buffer has a capacity of 4096 byte.

A query message is formed by adding a question mark to the respective header, e.g. FREQUENCY?.

If the ESVD is addressed as a talker directly after the query message, the bus handshake is disabled until the requested data are available. This may take several seconds since e.g. with *CAL? a calibration is performed before addressing. In this case it is more useful to wait for the MAV-bit (cf. section 3.3.5).

The syntax for data output is exactly the same as for commands received by the ESVD. <New Line> together with END (EOI active) is always used as terminator. The transmission of header and numeric value enables the messages sent by the ESVD as a talker to be returned unchanged from the controller to the test receiver. Thus a setting performed via the front panel can be read, stored in the controller and returned later to the receiver via the IEC-bus.

Notes:

If the ESVD receives several query messages, it also returns several messages within one line separated by semicolons (;).

Several numeric values (day, month and year) can be sent as a reply to certain query messages (e.g. SYSTEM:DATE?). They are separated by commas (,).

Header and numeric values are always separated by spaces. Headers only consist of upper-case letters and the characters ". " _ " and "".*

The messages sent by the ESVD do not contain units. In the case of physical variables, the numeric values are referred to the basic unit (cf. section 3.3.4.4).

Output of the header can be switched on or off using the commands "HEADER ON" and "HEADER OFF".

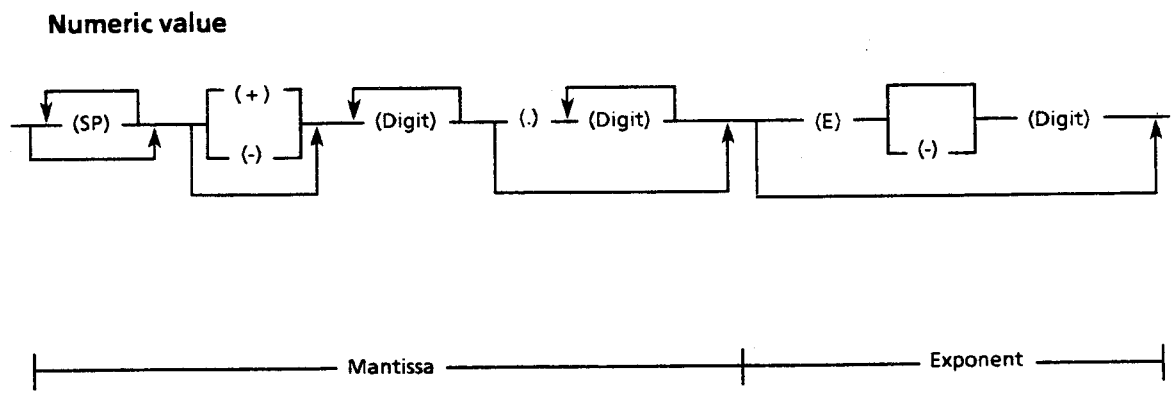
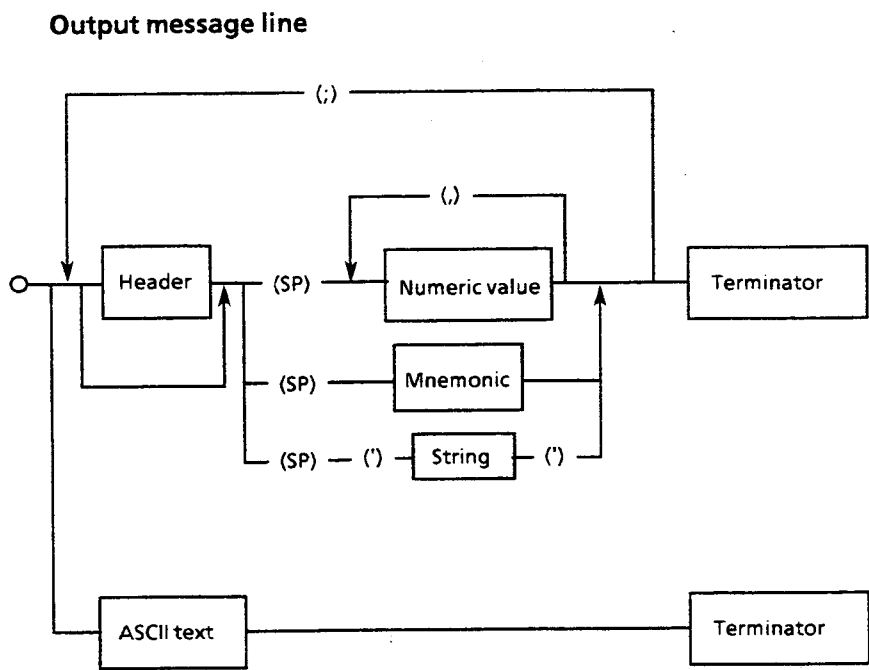

Fig. 3-35 Syntax diagram of messages sent by the receiver

3.3.4.3 Common Commands

The common, device-independent commands are grouped as follows:

- Commands referring to the Service Request function with the associated status and mask registers
- Commands for device identification
- Commands referring to the Parallel Poll function
- Commands for triggering sequences
- Commands for device-internal sequences (reset, calibrate, self-test) and for synchronizing sequences.

The common commands are taken from the new IEEE488.2 (IEC 625-2) standard. This ensures that these commands have the same effect in different devices. The headers of these commands consist of an asterisk "*" followed by three letters.

Table 3-21 Device-independent commands (common commands) received by the ESVD

Command	Numeric value/ Range	Meaning
*RST	---	Reset The receiver is set to its default status as it is possible with RCL 0 on the front panel. This command does not change the status of the IEC bus interface, the set IEC bus address, the mask registers of the Service Request function and the output buffer.
*PSC	-32767 to 32767	Power On Status Clear (reset on power-up) With a numeric value other than 0, the Service Request Enable mask register (SRE) and the Event Status Enable mask register (ESE) are cleared during power-up. If the value is equal to 0, the registers mentioned above retain their contents when the device is switched on and off. Bit 7 in the Event Status register is set when switching on the test receiver. If the Event Status and Service Request Enable register have the appropriate configuration prior to switch-off, a Service Request may be enabled (cf. section 3.3.5).
*OPC	--	Operation Complete (ready-signal) Sets bit 0 (Operation Complete) in the Event Status register (ESR), if all previous commands have been processed.
*CLS	--	Clear Status. Sets the status registers ESR and STB to zero. The mask registers of the Service Request function (ESE and SRE) are not changed. This command does not change the status of the IEC bus interface, the set IEC bus address, the mask registers of the Service Request function and the output buffer
*ESE	0 to 255	Event Status Enable The Event Status Enable mask register is set to the specified value which is interpreted as a decimal number (see section 3.3.5)

Command	Numeric value /Range	Meaning
*SRE	0 to 255	<p>Service Request Enable</p> <p>The Service Request Enable mask register is set to the specified value which is interpreted as a decimal number (cf. section 3.3.5).</p>
*PRE	0 to 65535	<p>Parallel Poll Enable</p> <p>The Parallel Poll Enable mask register is set to the specified value which is interpreted as a decimal number.</p>
*PCB	0 to 30	<p>Pass Control Back</p> <p>The numeric value specifies the address of the controller to which the IEC bus control is to be returned after completion of the plotter output.</p>
*TRG	---	<p>Trigger</p> <p>Level measurement of the ESVD is re-started, a current measurement is aborted. This command has the same function as the message GET. Measurement values are however not made available for output as the IEC bus standard permits output only following a query command.</p> <p>The device-specific commands are provided for this purpose:</p> <ul style="list-style-type: none"> ● LEVEL:LASTVALUE? the value of the last level measurement, which was triggered by e.g. *TRG, is made available in the output buffer. ● LEVEL? level measurement is started and the measured value is subsequently made available in the output buffer. ● LEVEL:CONTINUE? the value of the last level measurement is made available in the output buffer and a new level measurement is started. Same function as a sequence consisting of the commands LEVEL:LASTVALUE? and *TRG.
*RCL	0 to 9	<p>Recall</p> <p>Recalls a stored device setting (1 to 9). *RCL 0 sets the ESVD to its default status analog to the command *RST. The command has the same function as the RCL key.</p>
*SAV	1 to 9	<p>Save</p> <p>Saves a current device setting or a report configuration. Same function as the SAVE key.</p>
*WAI	---	<p>Wait To Continue</p> <p>Only processes the subsequent commands when all previous commands have been completely executed (cf. section 3.3.7).</p>

Table 3-21a Common Commands leading to data output

Command	Output message Data value		Meaning
	No. of digits	Range	
*IDN?	31	alphanumeric	Identification Query The following identification text is sent via the IEC bus as a reply to the *IDN? command (always without header). Example: ROHDE&SCHWARZ, ESVD,0,2 00, 02.00 ROHDE&SCHWARZ = Manufacturer ESVD = Model 0 = reserved for serial number, (not used with ESVD) 2.00 = Firmware version (example) 02.00 = Firmware version of boot PROMs
*PSC?	1	0 or 1	Power On Status Clear Query Reading the status of the Power On Clear flag (cf. *PSC)
*OPC?	1	0 or 1	Operation Complete Query (ready message) The message "1" is entered into the output buffer and bit 4 (message available) is set in the status byte when all previous commands have been completely executed. Bit 0 (operation complete) is also set in the Event Status register (cf. section 3.3.7).
*ESR?	1 to 3	0 to 255	Event Status Register Query The contents of the Event Status register is output in decimal form and the register then set to zero.
*ESE?	1 to 3	0 to 255	Event Status Enable Query The contents of the Event Status Enable mask register is output in decimal form. The gap in the range of values results from the fact that bit 6 (rsv) cannot be set. The value results from ORing of the other bits (cf. fig. 3-37).
*STB?	1 to 3	0 to 255	Status Byte Query The contents of the status byte is output in decimal form.
*SRE?	1 to 3	0 to 63 and 128 to 191	Service Request Enable Query The contents of the Service Request Enable mask register is output in decimal form. The gap in the range of values results from the fact that bit 6 (rsv) cannot be set. The value results from ORing of the other bits (cf. fig. 3-47).
*TST?	1 to 3	0 to 255	Self-Test Query A device self-test is executed. The output value "0" indicates proper termination of the self-test. Values > "0" signal faults in the respective module(s).
*IST?	1	s. Tab. 3-2	Individual Status Query Reads the current device status (Parallel Poll message to IEEE488.1). "0" means the current status is FALSE, "1" means TRUE.
*PRE?	1 to 3	0 to 255	Parallel Poll Enable Query The contents of the Parallel Poll register is output in decimal form.
*STB?	1 to 3	0 to 127	Status Byte Query The contents of the status byte is output in decimal form.
*CAL?	1 to 2	cf. tab. 3-21	Calibration Query The receiver is calibrated. If the calibration is completed successfully, "0" is output as a reply; otherwise a number between 27 and 613 the meaning of which can be learnt from table 3-23 is output. The commands "CALIBRATION:SHORT" or "CALIBRATION:TOTAL" serve to select the calibration to be performed (the commands however do not trigger a calibration!).

Table 3-22 Meaning of the Return Values of the Self-test

Value	Meaning
0	The self-test was completed without any error
1	+ 5-V-supply voltage out of tolerance
2	+ 10-V-supply voltage out of tolerance
3	-10-V-supply voltage out of tolerance
4	+ 28-supply voltage out of tolerance
15	Any other defect of the module CPU-board
18	Component of the real-time clock is defective
19	Serial bus is defective
44	VHF Synthesizer is defective
45	FRN Synthesizer is defective
103	IQ Demodulator is defective
105	VHF Preselector is defective
106	IF Selection Board is defective
107	2nd Mixer is defective
111	Detector board is defective

Table 3-23 Meaning of the Error Messages during Calibration

Output value	Meaning
27	The gain at the reference frequency 64 MHz cannot be controlled.
41	The gain with the 10-kHz IF bandwidth is out of tolerance.
47	The gain with the 300-kHz IF bandwidth is out of tolerance.
65	The IF gain switch is defective, so that its gain error cannot be corrected anymore.
81	The 30-dB operating range is defective and can no longer be used.
83	The 60-dB operating range is defective.
97	The correction value for the bandwidth in the indicating mode Pk/MHz is out of tolerance.
107	Quasi-peak weighting in band C is defective.

Table-3-23a

A filter range of the preselection is defective; frequency response amounts to more than 6 dB at the corresponding frequency:

Output value	Meaning	Output value	Meaning	Output value	Meaning
177	20.0 MHz	249	310.0 MHz	321	660.0 MHz
179	30.0 MHz	251	320.0 MHz	323	670.0 MHz
181	40.0 MHz	253	330.0 MHz	325	680.0 MHz
183	50.0 MHz	255	340.0 MHz	327	690.0 MHz
185	51.2 MHz	257	350.0 MHz	329	700.0 MHz
187	51.3 MHz	259	360.0 MHz	331	710.0 MHz
189	60.0 MHz	261	370.0 MHz	333	717.2 MHz
191	64.0 MHz	263	380.0 MHz	335	717.3 MHz
193	70.0 MHz	265	390.0 MHz	337	720.0 MHz
195	80.0 MHz	267	400.0 MHz	339	730.0 MHz
197	90.0 MHz	269	410.0 MHz	341	740.0 MHz
199	100.0 MHz	271	420.0 MHz	343	750.0 MHz
201	110.0 MHz	273	430.0 MHz	345	760.0 MHz
203	120.0 MHz	275	440.0 MHz	347	770.0 MHz
205	125.2 MHz	277	450.0 MHz	349	780.0 MHz
207	125.3 MHz	279	470.0 MHz	351	790.0 MHz
209	130.0 MHz	281	480.0 MHz	353	800.0 MHz
211	140.0 MHz	283	490.0 MHz	355	810.0 MHz
213	150.0 MHz	285	495.2 MHz	357	820.0 MHz
215	160.0 MHz	287	495.3 MHz	359	840.0 MHz
217	170.0 MHz	289	500.0 MHz	361	850.0 MHz
219	180.0 MHz	291	510.0 MHz	363	860.0 MHz
221	190.0 MHz	293	520.0 MHz	365	870.0 MHz
223	200.0 MHz	295	530.0 MHz	367	880.0 MHz
225	210.0 MHz	297	540.0 MHz	369	890.0 MHz
227	220.0 MHz	299	550.0 MHz	371	900.0 MHz
229	230.0 MHz	301	560.0 MHz	373	910.0 MHz
231	240.0 MHz	303	570.0 MHz	375	920.0 MHz
233	250.0 MHz	305	580.0 MHz	377	930.0 MHz
235	260.0 MHz	307	590.0 MHz	379	940.0 MHz
237	270.0 MHz	309	600.0 MHz	381	950.0 MHz
239	273.2 MHz	311	610.0 MHz	383	960.0 MHz
241	273.3 MHz	313	620.0 MHz	385	970.0 MHz
243	280.0 MHz	315	630.0 MHz	387	980.0 MHz
245	290.0 MHz	317	640.0 MHz	389	990.0 MHz
247	300.0 MHz	319	650.0 MHz	391	1000 MHz

Output value	Meaning	Output value	Meaning	Output value	Meaning
393	1000.1 MHz	467	1360.1 MHz	541	1710 MHz
395	1010 MHz	469	1370 MHz	543	1720 MHz
397	1020 MHz	471	1380 MHz	545	1730 MHz
399	1030 MHz	473	1390 MHz	547	1740 MHz
401	1040.1 MHz	475	1400 MHz	549	1750 MHz
403	1050 MHz	477	1410 MHz	551	1760.1 MHz
405	1060 MHz	479	1420 MHz	553	1770 MHz
407	1070 MHz	481	1430 MHz	555	1780 MHz
409	1080 MHz	483	1440.1 MHz	557	1790 MHz
411	1090 MHz	485	1450 MHz	559	1794.9 MHz
413	1100 MHz	487	1460 MHz	561	1795 MHz
415	1110 MHz	489	1470 MHz	563	1800 MHz
417	1120.1 MHz	491	1480 MHz	565	1810 MHz
419	1130 MHz	493	1490 MHz	567	1820 MHz
421	1140 MHz	495	1500 MHz	569	1830 MHz
423	1150 MHz	497	1510 MHz	571	1840.1 MHz
425	1160 MHz	499	1520.1 MHz	573	1850 MHz
427	1170 MHz	501	1521.9 MHz	575	1860 MHz
429	1180 MHz	503	1522 MHz	577	1870 MHz
431	1190 MHz	505	1530 MHz	579	1880 MHz
433	1200.1 MHz	507	1540 MHz	581	1890 MHz
435	1210 MHz	509	1550 MHz	583	1900 MHz
437	1220 MHz	511	1560 MHz	585	1910 MHz
439	1230 MHz	513	1570 MHz	587	1920.1 MHz
441	1240 MHz	515	1580 MHz	589	1930 MHz
443	1249.9 MHz	517	1590 MHz	591	1940 MHz
445	1250 MHz	519	1600.1 MHz	593	1950 MHz
447	1260 MHz	521	1610 MHz	595	1960 MHz
449	1270 MHz	523	1620 MHz	597	1970 MHz
451	1280.1 MHz	525	1630 MHz	599	1980 MHz
453	1290 MHz	527	1640 MHz	601	1990 MHz
455	1300 MHz	529	1650 MHz	603	2000.1 MHz
457	1310 MHz	531	1660 MHz	605	2010 MHz
459	1320 MHz	533	1670 MHz	607	2020 MHz
461	1330 MHz	535	1680.0 MHz	609	2030 MHz
463	1340 MHz	537	1690 MHz	611	2040 MHz
465	1350 MHz	539	1700 MHz	613	2050 MHz

Note: Warnings are not considered and result in the return value 0.

A more detailed description of the error messages can be obtained in section 3.2.3.12.3, "Error Messages during Calibration".

3.3.4.4 Device-specific Commands

The query messages are identified by an added "?". They enable the ESVD to transmit device settings or measured values to the controller. The structure of the data output format is the same as that of data input thus making it possible that the data read by the controller can be returned to the test receiver without further processing in the controller. If no unit is stated, the respective basic unit is used (Hz, s, dB, %). The used syntax is in accordance with the new standard "IEEE 488.2" that has been valid since 11/87. Program examples concerning IEC bus programming are stated in section 3.5.

Note: When reading the data in the controller please do make sure that the settings of the terminators are correct. The R&S-BASIC command for ASCII-texts is IEC TERM 10; for binary data IEC TERM 1.

Some headers can be abbreviated. The shortest possible notation is marked by bold letters in the tables 3-24 to 3-28.

Table 3-24 Receiver Functions

Command	Data	Unit	Meaning
A TENUATION A TENUATION? :AUTO :AUTO? :MODE :MODE? :ZSD?	0 to 120 dB I NCREMENT D ECREMENT O N O FF L OWNOISE L OW D ISTORTION ---	DB --- ---	RF attenuation Auto-range on off Attenuation mode Zero Scale Deflection
B ANDWIDTH: I F :IF?	10 kHz to 1 MHz	HZ KHZ MHZ GHZ	IF bandwidth of the receiver
C ALIBRATION: S HORT :TOTAL :CORRECTION	--- --- O N O FF	--- --- ---	Short calibration Configure total calibration (cf. *CAL? table 3-20) Considering the calibration correction values during level measurement on/off
D EMODULATION D EMODULATION?	F M A 3 A 0 O FF	---	Demodulation mode
D ETECTOR D ETECTOR?	A VERAGE P EAK Q UASIP E AK P EAK M HZ	---	Weighting mode (Detector)

Command	Data	Unit	Meaning
FREQUENCY FREQUENCY?	20 to 1000 MHz	HZ KHZ MHZ GHZ	Receiver frequency
	INCREMENT DECREMENT		Step up Step down
:STEPSIZE	0 Hz to 1000 MHz	HZ KHZ MHZ GHZ	Step size of frequency variation
:STEPSIZE?			
:VARIATION :VARIATION?	STEP COARSE FINE LOCK	---	Step size of frequency variation using rotary knob
LEVEL?	---	---	Starting a level measurement and making the measured value available
:CONTINUE?	---	--	Making the value of the last level measurement available in the output buffer and starting a new measurement.
:LASTVALUE?	---	---	Making the value of the last level measurement available in the output buffer.
:FORMAT :FORMAT?	ASCII BINARY	---	Measured value output with ASCII characters. Measured value output in binary format.
MEASUREMENT:TIME MEASUREMENT:TIME?	1 ms to 100 s	S MS	Measuring time
PREAMPLIFIER PREAMPLIFIER?	ON OFF	---	Preamplifier on/off
RANGE RANGE?	30 dB 60 dB	DB	Operating range
SPECIALFUNC SPECIALFUNC?	Number, ON/OFF (,Number, ON/OFF...) 0 1 2 10 12 13 16 17 20 30 31 32 33 51 52	---	Special functions: Default setting CISPR bandwidths Coupled measuring times Background lighting Coding socket Beeper Limit check Transducer check Unit dBm Double measurement modes: Peak + AV Peak + Pk/MHz Peak + quasi-peak Quasi-peak + AV External trigger positive edge External trigger negative edge
UNIT?	---	---	Polling the level unit

Table 3-24 RF-analysis

Command	Data	Unit	Meaning
GRID:FREQAXIS GRID:FREQAXIS? :MINLEVEL :MINLEVEL? :MAXLEVEL :MAXLEVEL?	LIN LOG -200 to + 200 -200 to + 200	--- DB DB	Pitch of axes of the diagram of RF-analysis Minimum level of the diagram of RF-analysis Maximum level of the diagram of RF-analysis
LIMIT LIMIT? :TEXT :TEXT? :DEFINE :DEFINE? :VALUE?	1 to 22 [,ON] 1 to 22 [,OFF] "ASCII text" max. 8 characters Number, Frequency 1, level 1, Frequency 2, level 2... n[,limit 1[,limit 2]] n: number of limit lines, 0 to 2 limit 1: 1st limit limit 2: 2nd limit	--- --- HZ KHZ MHZ GHZ DB DB	Selecting and switching on or off limit lines Name of limit line Definition of limit line by frequency-level pairs in increasing order Output of interpolated intermediate values at the current receiver frequency. The value 0 is returned if no limit lines have been switched on.
SCAN SCAN? :RUN :INTERRUPT :CONTINUE :STOP :RANGES :RANGES? :FREQUENCY:START :START? :STOP :STOP? :STEPMODE :STEPMODE? :STEPsize :STEPsize? :SAVE	1 to 5 1 to 5 Receiver frequency range, Receiver frequency range, LIN LOG 0 to 30 MHz 0 to 100 %	--- --- HZ, KHZ, MHZ, GHZ HZ, KHZ, MHZ, GHZ --- HZ, KHZ, MHZ, GHZ PCT ---	Selection of a partial scan Starting a scan Interrupting a scan Continuing an interrupted scan Stopping a scan Number of scans to be executed Start frequency of partial scan Stop frequency of partial scan Type of step size, the same for all partial scans Step size, in Hz for linear steps, in % for logarithmic frequency switching The scan settings for the start and stop frequency as well as the step size are adopted and checked whether they are consistent using this command. Error messages refer to the previous settings for the partial scan ranges.
:RECEIVER:MEASUREMENT:TIME :MEASUREMENT:TIME? :DETECTOR :DETECTOR?	1 ms to 100 s AVERAGE PEAK QUASIPeAK PEAKMHz	S MS ---	Measuring time per measured value of partial scan Weighting mode for partial scan

Command	Data	Unit	Meaning
: BANDWIDTH:IF : BANDWIDTH:IF?	10 kHz to 120 kHz	HZ, KHZ, MHZ, GHZ	IF-bandwidth for partial scan
: ATTENUATION : ATTENUATION?	0 to 120 dB	DB	RF-attenuation for partial scan (manual)
: ATTENUATION:AUTO : ATTENUATION:AUTO?	ON OFF	---	Auto-range on/off
: ATTENUATION:MODE : ATTENUATION:MODE?	LOWNOISE LOWDISTORTION	---	IF-attenuation for partial scan
: RANGE : RANGE?	30 dB, 60 dB	DB	Operating range
: PREAMPLIFIER : PREAMPLIFIER?	ON OFF	---	Preamplifier for partial scan
: DEMODULATION : DEMODULATION?	A3, A0, OFF		Demodulation for partial scan
SCAN:OPTION			Special functions of RF-analysis
: SUBRANGES : SUBRANGES?	8 16 25 50 100 200 400	---	Number of subranges
: FASTSCAN	ON OFF	---	Fast Scan with fixed RF attenuation
: MARGIN : MARGIN?	-200 to 200 dB	DB	Margin from acceptance line to limit line
: GATEDSCAN : GATEDSCAN?	ON OFF		Option Gated Scan
: SPECIALSCAN : SPECIALSCAN?	ON OFF		Switching on/off the option Special Scan.
: STYLE : STYLE?	CURVE LINE	---	The measurement curves can be represented either in the form of a closed curve (CURVE) or vertical lines (LINE).
: MAXLEVEL : MAXLEVEL?	-200 to 200 dB	DB	Maximum level of the RF analysis diagram
: MINLEVEL : MINLEVEL?	-200 to 200 dB	DB	Minimum level of the RF analysis diagram
: MAXFREQ : MAXFREQ?	Receiver frequency range	HZ, KHZ; MHZ, GHZ	Maximum frequency of the RF analysis diagram
: MIN FREQ : MIN FREQ?	Receiver frequency range	HZ, KHZ; MHZ, GHZ	Minimum frequency of the RF analysis diagram
: FREQUENCIES : FREQUENCIES?	Number, Frequency1, Frequency2,	HZ, KHZ; MHZ, GHZ	Frequency values for the option Special Scan; max. 400 values in increasing sequence

Command	Data	Unit	Meaning
:REPETITIVE :REPETITIVE?	OFF MAXHOLD CLRWRITE MAXCLR	---	Operating mode "Repetitive Scan" Storage of the maximal values Overwriting of previous measured values Clr/Write + Maxhold
SCAN:BLOCK?		---	Output of the scan results in the form of blocks (cf. section 3.3.8 and 3.5)
:COUNT :COUNT?	Number	---	Number of the measured values that are transmitted in a block (the max. number depends on the structure of the data). The value 0 means: measured value output during scan is switched off.
	MAX MAX?		The output buffer is used to its maximum. Max. number of block elements.
	SUBRANGE		All the measured values of a subrange are combined to form a block, if the size of the output buffer is sufficient.
:ELEMENT	COMBINED	---	All level values measured including the frequency and different additional information are transmitted.
	TRACE		Only the results of the 400 subrange maxima are transmitted.
	SUBRMAX		Only the results of the user subranges defined using SCAN:OPTION:SUBRANGES are transmitted.
	DET1		Level values detector 1
	DET2		Level values detector 2
	VALID		Validity bytes
:FORMAT :FORMAT?	ASCII BINARY DUMP SDUMP		Output format for scan results (cf. section 3.3.8.)
:SIZE?	---		Size of a block element when the measured values are output in the form of bytes (this size is variable for output in ASCII format)
:TEMPLATE?	---		Composition of the individual components of a block element (see chapter 3.3.8).
SCAN:RESULTS	---	---	Using this command, scan results can be output at a later date. This command sets the appropriate bits in the ERD register, however does not make available the data in the output buffer.
:CLEAR	---	---	Clearing the memory with measured values

Table 3-25 Transducer

Command	Data	Unit	Meaning
TRANSDUCER	OFF	---	Switching off consideration of transducer factors
:FACTOR :FACTOR?	1 to 22		Selecting a transducer factor
:TEXT :TEXT?	"ASCII text" max. 8 characters		Name of transducer
:DEFINE :DEFINE?	Number Frequency 1, level 1, Frequency 2, level 2, ...	HZ, KHZ, MHZ, GHZ, DB	Definition of transducer factors by frequency-level pairs in increasing order
:VALUE?		---	Output of the interpolated intermediate value at the current receiver frequency
:SELECT :SELECT?	1 to 22		Activating a transducer factor
:UNIT :UNIT?	DB, DBUV, DBUV.M, DBUA DBUA.M, DBPW		Unit of transducer factor
:SET	1 to 5	---	Selecting a transducer set
:SET:SELECT :SET:SELECT?	1 to 5, NONE		Activating a transducer set
:RANGES :RANGES?	1 to 5		Number of ranges of a transducer set
:NUMBER :NUMBER?	1 to 5		Selecting a transducer set range
:START :START?	20 to 1000 MHz	HZ, KHZ, MHZ, GHZ	Start frequency of the selected transducer set range
:STOP :STOP?	20 to 1000 MHz	HZ, KHZ, MHZ, GHZ	Stop frequency of the selected transducer set range
:DEFINE :DEFINE?	Number, factor1, factor2, ...	---	Selecting the transducer factors that are combined in a transducer set range.
:UNIT :UNIT?	DB, DBUV, DBUV-M, DBUA DBUA-M, DBPW	---	Unit of the transducer set
:TEXT :TEXT?	"ASCII-text" max. 8 characters		Designation of the transducer set

Table 3-26 Test Report

Command	Data	Unit	Meaning
PLOTTER:START	---	---	Starting plotter output (transfer of controller function is required (cf. section 3.3.9, program examples cf. 3.5).
:SETUP:FORMAT :SETUP:FORMAT?	ON OFF	---	Special scaling of plotter output on/off
:LEFT	-99.999 to 99.999	---	Definition of the limits P1 and P2: Left margin
:LEFT?	Plotter-Units	---	Right margin
:RIGHT		---	Top margin
:RIGHT?		---	Bottom margin
:TOP		---	
:TOP?		---	
:BOTTOM		---	
:BOTTOM?		---	
:SETUP:PEN :SETUP:PEN?	ON OFF	---	Selection of pen for plotter output on/off Pen for:
:GRID	0 to 8	---	Diagram
:GRID?		---	Limit line
:LIMIT	0 to 8	---	Measurement curve 1
:LIMIT?		---	Measurement curve 2
:CURVE1	0 to 8	---	Labelling
:CURVE1?		---	List of measured values
:CURVE2	0 to 8	---	
:CURVE2?		---	Data
:TEXT	0 to 8	---	
:TEXT?		---	
:SINGLEVALUES	0 to 8	---	
:SINGLEVALUES?		---	
:DATE	0 to 8	---	
:DATE?	0 to 8	---	
:CONTENT:DEFAULT :CONTENT:DEFAULT?	ON OFF	---	Elements of a test report: Default setting
:CURVE	ON	---	Measurement curve(s)
:CURVE?	OFF	---	Header of protocol
:HEADER	ON	---	Diagram
:HEADER?	OFF	---	List of measured values
:DIAGRAM	ON	---	Table with scan data
:DIAGRAM?	OFF	---	Data
:LIST	ON	---	
:LIST?	OFF	---	
:SCANTABLE	ON	---	
:SCANTABLE?	OFF	---	
:DATE	ON	---	
:DATE?	OFF	---	

Command	Data	Unit	Meaning
PRINTER:START :STOP	---	---	Starting printer output Stopping printer output
:CONTENT:DEFAULT :CONTENT:DEFAULT?	ON OFF	---	Elements of a test report: Default setting
:CURVE :CURVE?	ON OFF	---	Measurement curve(s)
:HEADER :HEADER?	ON OFF	---	Header of protocol
:DIAGRAM :DIAGRAM?	ON OFF	---	Diagram
:LIST :LIST?	ON OFF	---	List of measured values
:SCANTABLE :SCANTABLE?	ON OFF	---	Table with scan data
REPORT:HEADER:COMPANY :COMPANY?	"ASCII text" (max.40 characters)	---	texts for the protocol header Test company
:PROGRAM :PROGRAM?	"ASCII text" (max.40 characters)	---	Measurement program
:EUT :EUT?	"ASCII text" (max.40 characters)	---	Equipment under test
:MANUFACTURER :MANUFACTURER?	"ASCII text" (max.40 characters)	---	Manufacturer
:CONDITION :CONDITION?	"ASCII text" (max.40 characters)	---	Operating conditions
:OPERATOR :OPERATOR?	"ASCII text" (max.40 characters)	---	Operator
:SPEC :SPEC?	"ASCII text" (max.40 characters)	---	Test specifications
:REMARK1 :REMARK1?	"ASCII text" (max.60 characters)	---	Remark/comment
:REMARK2 :REMARK2?	"ASCII text" (max.60 characters)	---	Remark/comment

Table 3-27 Common Commands

Command	Data	Unit	Meaning
ERA?	---	---	Event Status register A for specifying the instrument states
ERAE ERAE?	0 to 65535	---	Event Status Enable register A
ERB?	---	---	Event Status register B for indicating synthesizer errors.
ERBE ERBE?	0 to 65535	---	Event Status Enable register B
ERC?	---	---	Event Status register C for specifying the validity of a measured value (section 3.3.8)
ERCE ERCE?	0 to 65535	---	Event Status Enable register C
ERD?	---	---	Event Status register D for specifying the scan states
ERDE ERDE?	0 to 65535	---	Event Status Enable register D
HEADER	ON OFF	---	Switching on and off output of header during poll
LISN LISN? :PHASE :PE	ESH2Z5 ESH3Z5 N L1 L2 L3 GROUNDED FLOATING	---	Selecting the LISN to be controlled Setting the phase; with ESHS3-Z5, N and L1 are permissible only Setting the PE
PRESET	---	---	Resetting of device settings without resetting IEC-bus interface. It corresponds to the function RCL0.
SERVICE:SELFTTEST:CALGEN	ON OFF	---	Switching on/off the calibration generator
SYSTEM:ERRORS?	---	---	Polling device-dependent errors (cf. table 3-31)
:DATE :DATE?	dd,mm,yy	---	Date of real-time clock
:TIME :TIME?	hh,mm,ss	---	Time of real-time clock
TERMINATOR	LFEOI EOI	---	Listener terminator: Linefeed (10 decimal) with EOI only EOI for binary data
USERPORT	1 to 6, ON 1 to 6, OFF	---	Setting the user port



Table 3-27a Commands for reading out device configurations

Command	Data	Unit	Meaning
SYSTEM:SETUP	Block data	---	The complete receiver configurations (without transducer and limit lines) can be read out in the form of arbitrary length block data. The data can be reprogrammed in the same form. Block size approx. 12.5 kbyte
:BANDWIDTH?	---	--	Polling the bandwidths of the IF filters integrated in the device. Output in ASCII format; the values are separated by commas.
:RECEIVER :RECEIVER?	Block data	---	Complete receiver settings, such as SYSTEM:SETUP?, however without SAVE or RECALL data can be read out in the form of arbitrary length block data. The data can be reprogrammed in the same form.
:LIMIT :LIMIT?	Block data	---	All limit lines can be read out in the form of arbitrary length block data. The data can be reprogrammed in the same form. Block size approx. 6 kByte
:TRANSDUCER :TRANSDUCER?	Block data	---	The complete transducer factors and transducer sets can be read out in the form of arbitrary length block data. The data can be reprogrammed in the same form. Block size approx. 11 kByte
:LABEL :LABEL?	n, "label", n, "label" ..., n: register "label": name of register	---	The names of the SAVE/RECALL registers can be programmed and queried. After the query, the complete list from 1 to 9 is provided. Any combination can be programmed.



3.3.5 Service Request and Status Register

In line with the new IEC bus standard the ESVD features the following registers:

- Event Status (ESR)
- Event Status Enable (ESE)
- Status byte (STB)
- Service Request Enable (SRE) and
- Parallel Poll Enable (PRE).

The individual registers have the following meanings:

a) Event Status (ESR):

The Event Status register is an extended version of the status byte used in earlier IEC bus programmable measuring instruments. In this register the ESVD specifies special events that can be polled by the controller. The respective bit associated with the event or status is set to 1. This bit remains set until it is cleared by reading the Event Status register (command *ESR?) or by one of the following conditions:

- the commands *RST or *CLS
- switching on the power supply voltage (the power-on bit is however set afterwards).

Table 3-29 Meaning of the individual bits of the Event Status register

Bit No.	Meaning
7	Power On Is set when the device is switched on or the power returns following a power failure.
6	User Request This bit is set in the ESR by activating the LOCAL key. If the mask register is set appropriately, the ESVD can generate a Service Request of the controller.
5	Command Error Is set, if one of the following errors is detected during analysis of the received commands: <ul style="list-style-type: none"> ● syntax error ● illegal unit ● illegal header ● a numeric value was combined with a header that requires no subsequent numeric value.
4	Execution Error Is set, if one of the following errors was detected during execution of the received commands: <ul style="list-style-type: none"> ● A numeric value is out of the permissible range (for the respective parameter) ● A received command is incompatible with a currently active device setting.
3	Device-dependent Error Is set, if function errors occur.
2	Query Error Is set, if: <ul style="list-style-type: none"> ● an attempt is being made by the controller to read data from the ESVD when no query command has been issued before ● the data prepared in the output buffer are not read and instead a new command is sent to the ESVD. The output buffer is cleared in this case.
1	Request Control Is set, if the ESVD requires the IEC bus for control purposes (e.g. plotter).
0	Operation Complete Is set in response to the commands *OPC and *OPC? when all the pending commands have been processed and executed.



b) Event Status Enable (ESE):

This register is set by the controller and forms the mask for the Event Status register. The user can select which bits in the Event Status register also effect the setting of the sum bit ESR (bit 5 in the status byte) thus enabling a service request. The sum bit can only be set when at least one bit in the ESR and the appropriate bit in the ESE are set to 1. The sum bit is automatically cleared, when the condition stated above no longer prevails, e.g. when the bits in the ESR have been cleared by reading out the ESR or, when the ESE-register has been changed. The ESE-register is set to zero upon switching on the power supply when the power-on-status-clear flag is 1 (*PSC 1). The command "*ESE value" serves to set the Event Status Enable mask register where "value" is the contents of the register in decimal form. The current value of the register can be read out again using *ESE?.

c) Status byte (STB):

There are the following ways for reading the status byte:

- By way of the command *STB?
The contents is output in decimal form. The status byte is not changed by the readout and the Service Request is not cleared.
- By way of a Serial Poll
The contents is transmitted in binary form. As a result the RQS-bit is set to zero and the Service Request inactive, the remaining bits of the status byte are not changed.

The status byte is cleared:

- By way of the command *CLS, provided that the output buffer is empty.
This command clears the Event Status register (ESR) and the output buffer, thus setting the bit ESR in the status byte to zero. This in turn brings about the clearing of the RQS-bit and the Service Request message.
- By reading the ESR using *ESR? or by setting the ESE to zero using *ESE 0 or by reading the contents of the output buffer.

Table 3-30 Meanings of the individual bits of the status byte

Bit	Bus line	Designation	Meaning
0	DIO 4	ERD	Sum bit of the Event Status register D for specification of the scan states.
1	DIO 5	ERC	Sum bit of the Event Status register C for identification of the validity of a measured value.
2	DIO 6	ERB	Sum bit of the Event Status register B for specifying synthesizer loop errors.
3	DIO 7	ERA	Sum bit of the Event Status register A for specification of device states.
4	DIO 6	MAV	Message available, i.e. output buffer is not empty, a message available, e.g. a measured value can be read.
5	DIO 6	ESR	Sum bit of the Event Status register
6	DIO 6	RQS	Request Service

d) Service Request Enable (SRE)

This mask register for the status byte can be set by the controller. The conditions that enable a Service Request can thus be selected. The command SRE 32, for example, sets the mask register such that a Service Request is only generated when the ESR-bit is set. When switching on the power supply the SRE-register is reset (= 0) provided that the Power On Clear flag has the value "1". The SRE-register is not changed by DCL and SDC.

According to the standard, the bit positions 0 to 3 and 7 can be freely assigned for further events. In the case of the ESVD the bits 0 to 3 (ERA, ERB, ERC and ERD) are used to specify certain events and states.

e) Parallel Poll Enable Register

The Parallel Poll Enable register has a capacity of 16 bit. Each bit in this register has a corresponding bit in the status byte or in a device-specific register. If the bit-for-bit operation of the Parallel Poll Enable register with the two ones stated above does not result in 0, the IST-bit (Individual Status) is set to 1. The IST-bit is sent as a reply to a parallel poll of the process controller, thus allowing the identification of the reason for the service request. (The IST-bit can also be read using "*IST?"). Figure 3-41 illustrates the relations.

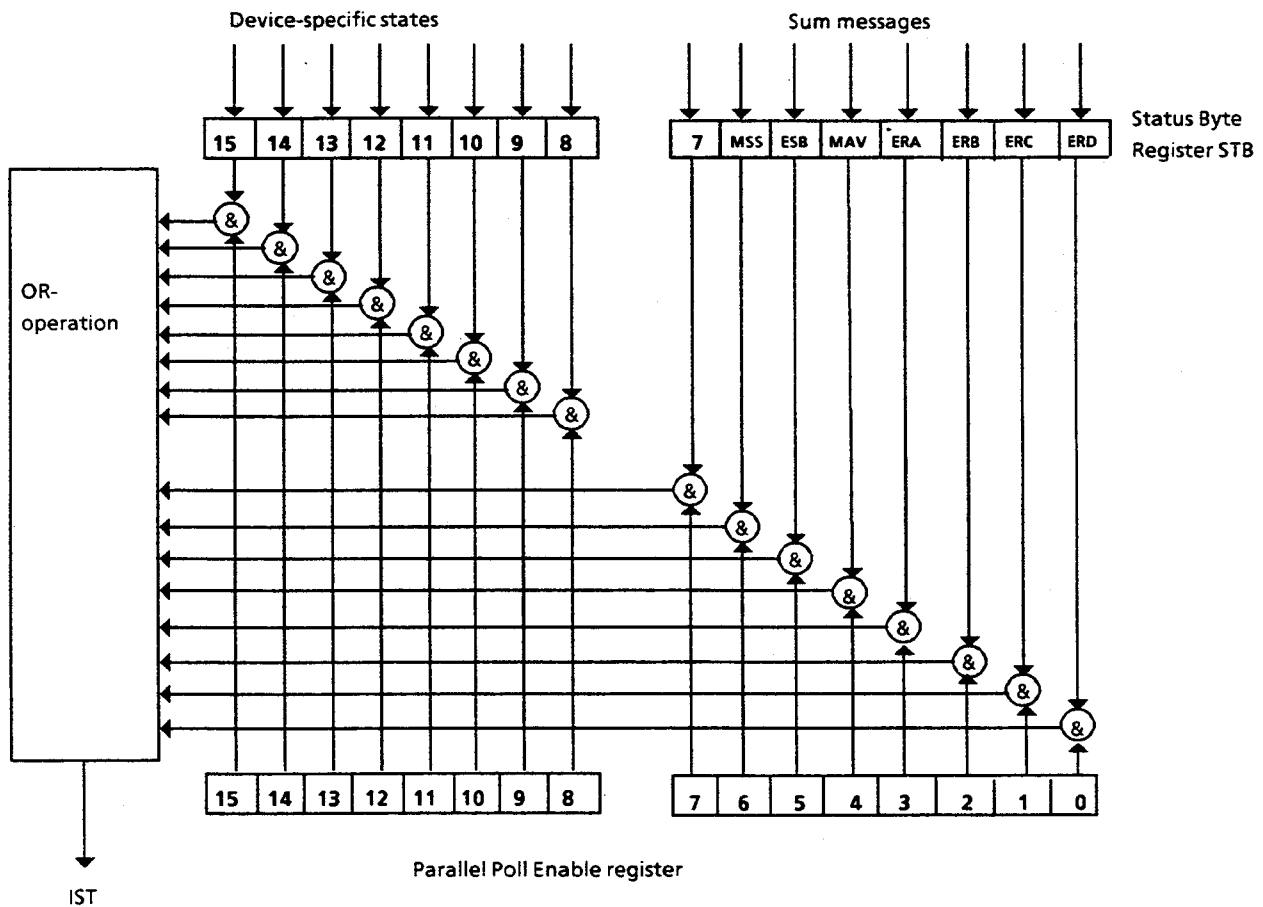

Fig. 3-36 Parallel Poll Enable Register PRE

f) Assignment and relation of the individual registers

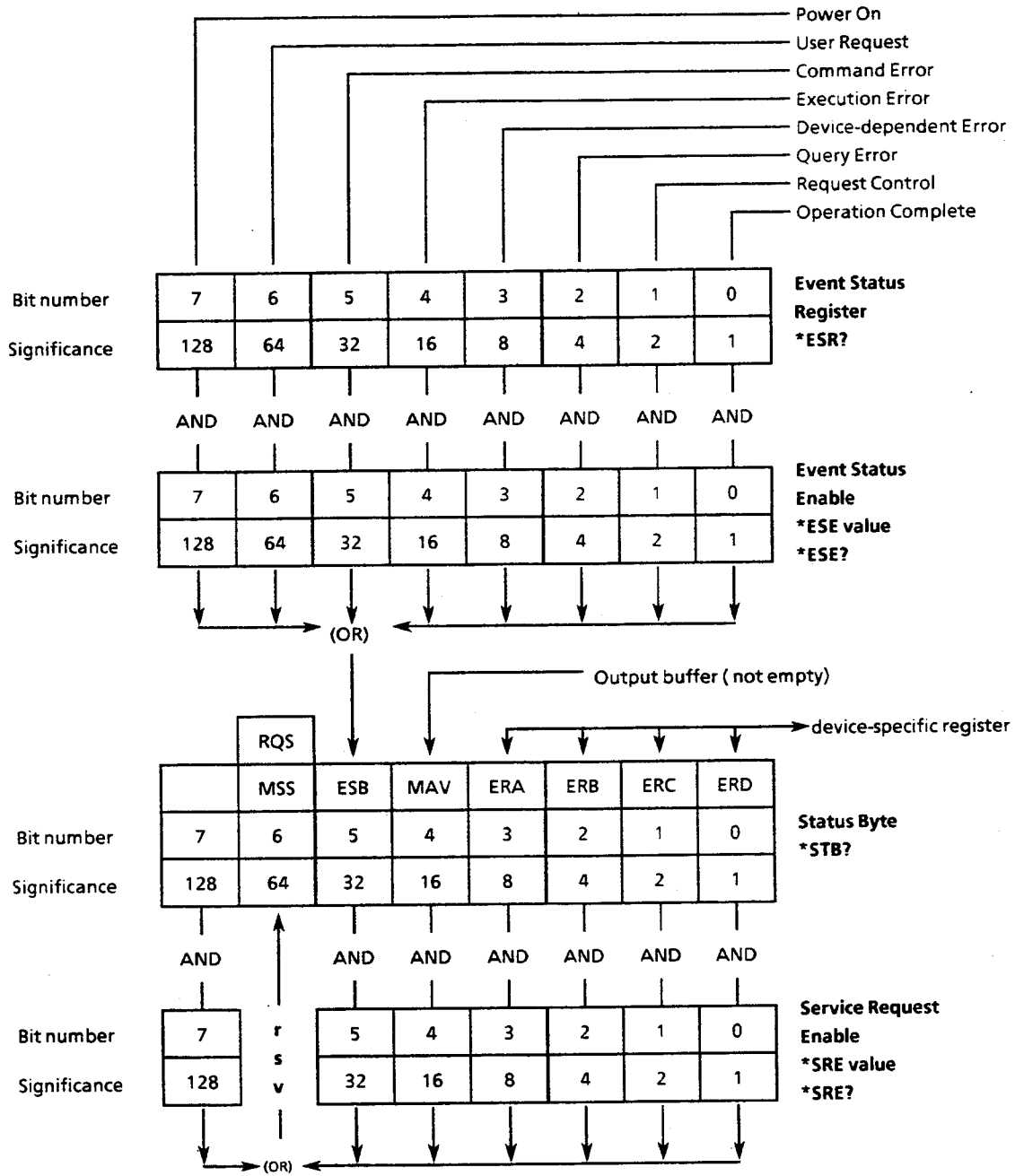

Fig. 3-37 Status register

Event Status Register A:

The assignment of the extended Event Register ERA and the identification of the instrument states are explained by the following diagram:

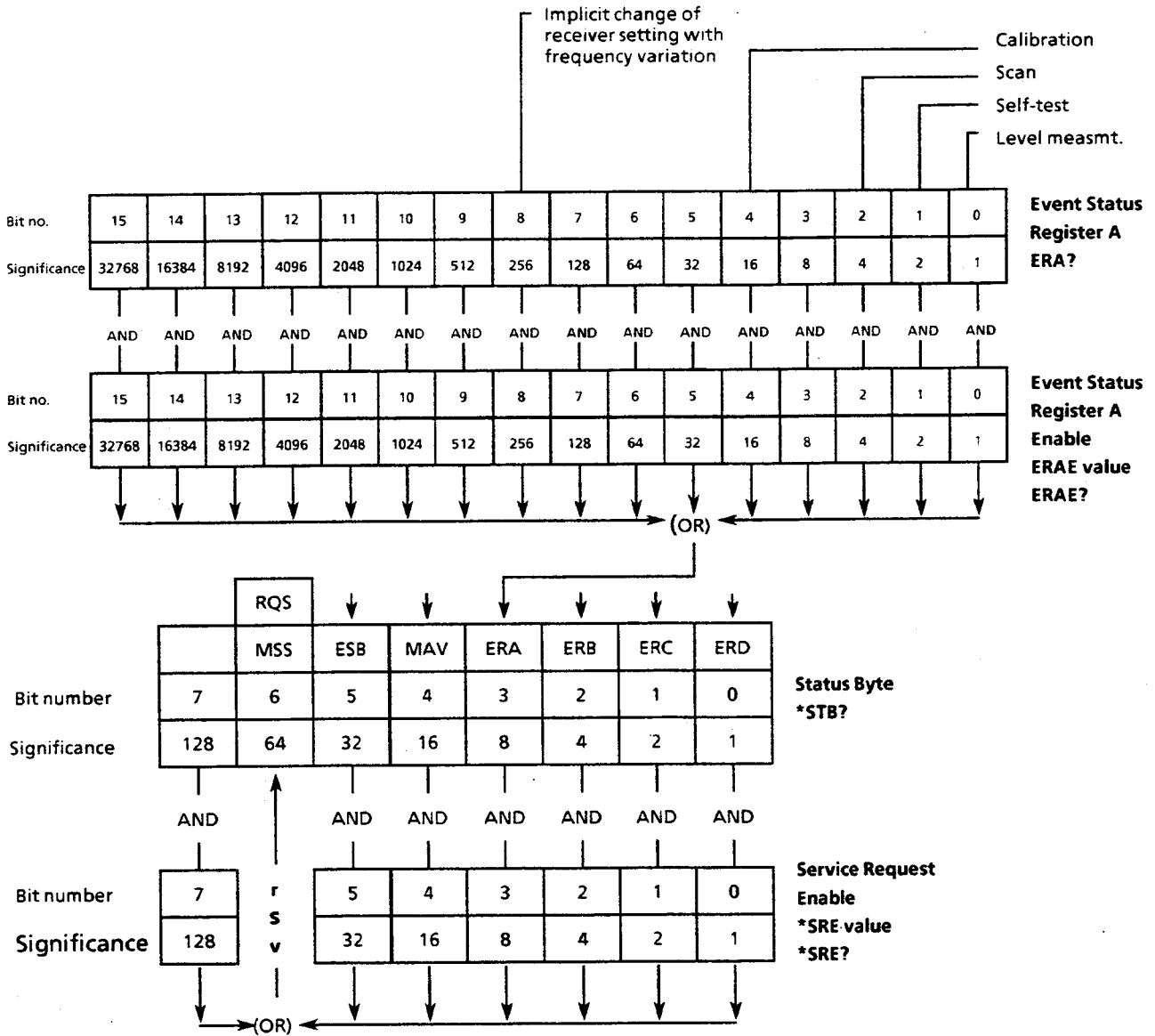

Fig. 3-38 Status register ERA

Bit 8 is set when by a frequency variation another receiver setting is automatically changed. This may be for example the IF bandwidth. The other bits indicate that certain functions are active. They are reset again after this functions have been terminated.

Event Status Register B:

The assignment of the extended Event Register ERB is illustrated by the following diagram:

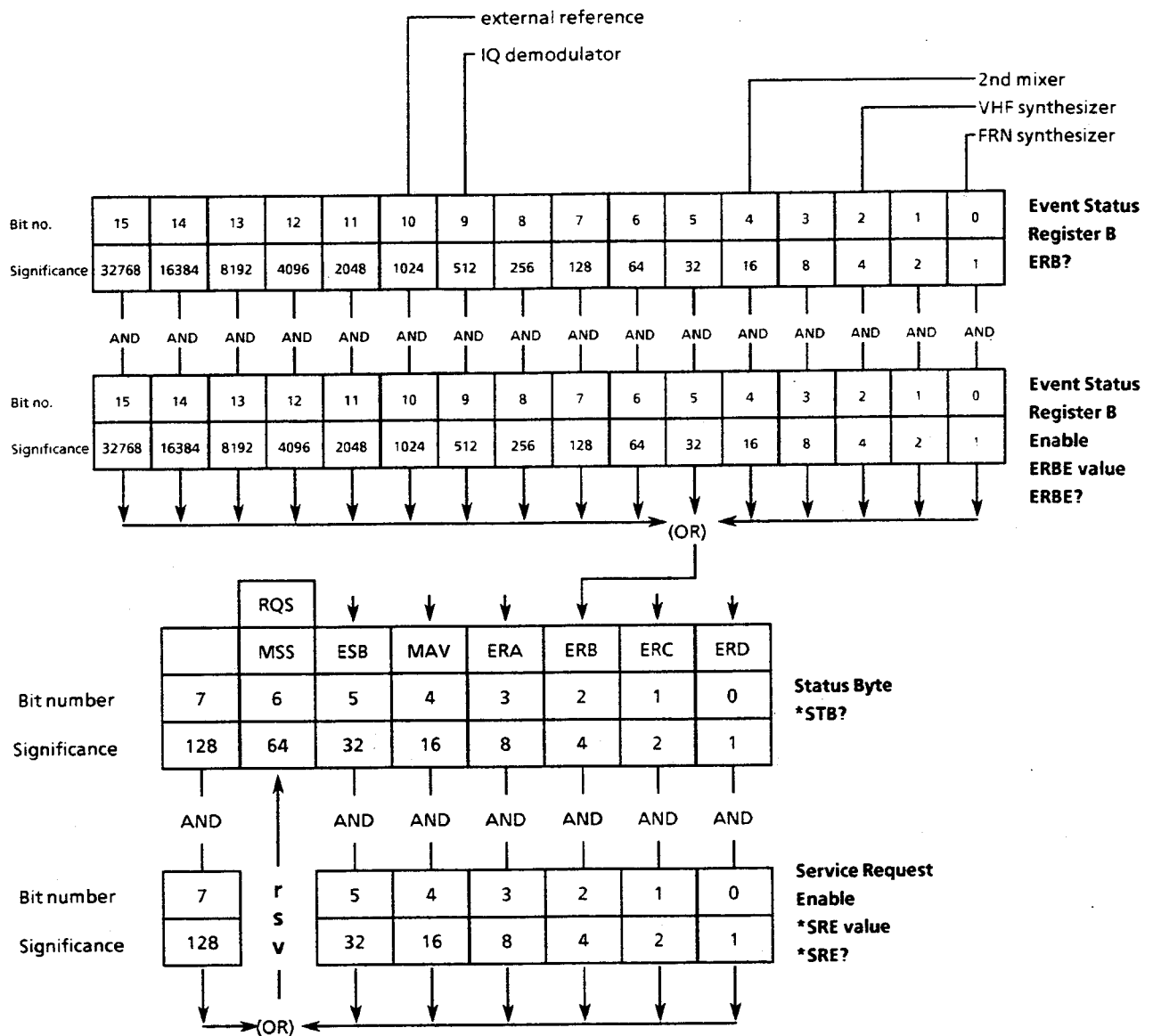

Fig. 3-39 Status register ERB

Bit 10 is set, when the external reference is switched on or off. "FREQUENCY:EXTREF?" is used to determine the exact state. The other bits are set on the occurrence of a synthesizer loop error.

Event Status Register C:

The assignment of the extended Event Register ERC and the indication of the validity of the measured values are shown in the following diagram:

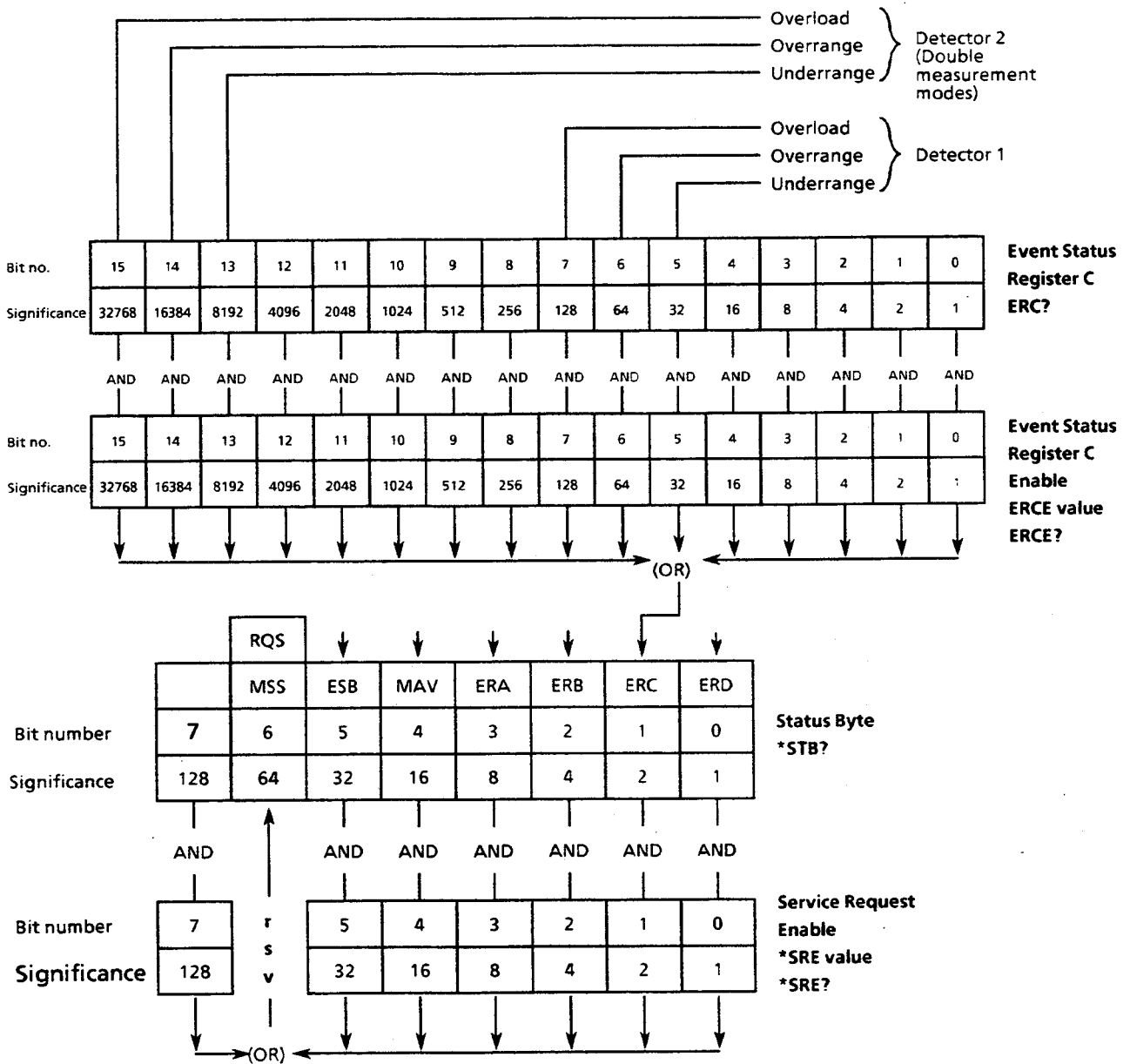

Fig. 3-40 Status register ERC

Event Status Register D:

The assignment of the extended Event Register ERD and the identification of the scan states are illustrated in the following diagram:

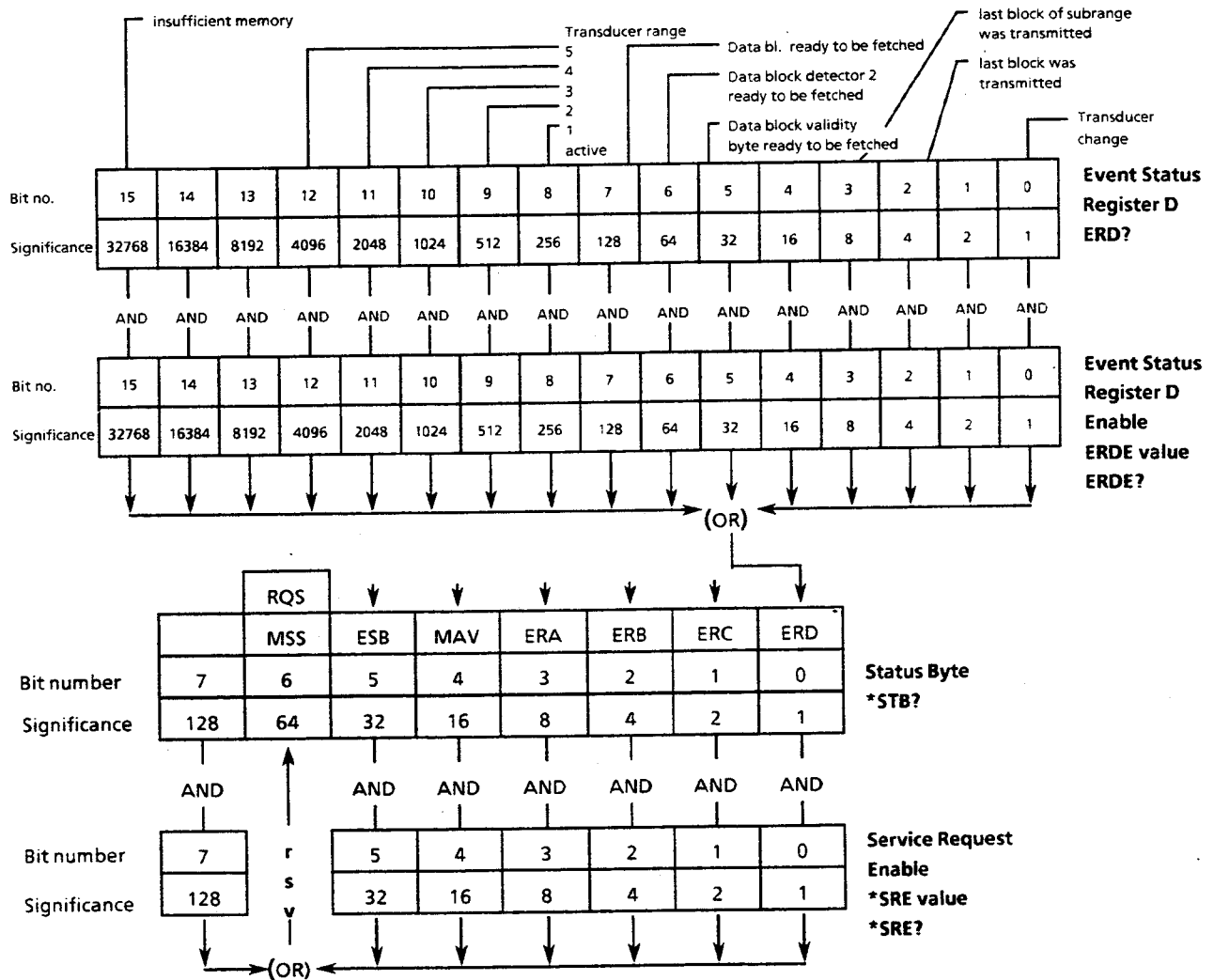

Fig. 3-41 Event Status Register D

Reaching an antenna switch-over point during a scan causes the "transducer change" bit to be set in the Event Status Register D.

The index of the active antenna range (Transducer Range) is identified by setting the appertaining bit in the register.

With the set number of measured values (SCAN:BLOCK:COUNT) being ready for output during a scan, the "data block ready to be fetched" bit is set in the Event Status Register D.

With unformatted output selected (SCAN:BLOCK:FORMAT DUMP) bit 7 indicates the availability of results for detector 1. For detector 2 bit 6 has this function and for the validity byte bit 5, respectively. Bit 2 indicates the end of transmission of the last data block. Synchronization with the end of the scan is possible via the "operation complete" mechanism irrespective of completion of transmission.

Bit 3 is used when "SCAN:BLOCK:COUNT SUBRANGE" was selected. It is set after all block elements appertaining to a subrange have been output.

Bit 15 indicates that more measurement results are to be expected than can be stored in the internal measured value memory. The bit is set already at the beginning of the scan.

3.3.6 Resetting of Device Functions

The following table shows various commands and events that cause individual device functions to be reset:

Table 3-30 Resetting of various device functions

Event	Switching on the operating voltage		DCL, SDC (Device Clear, Selected Device Clear)	Commands		
	Power On Clear Flag			*RST	*CLS	RCL 0
	0	1				
Device default setting	--	--	--	yes	--	yes
Set ESR to zero	yes	yes	--	---	yes	---
Set ESE and SRE to zero	--	yes	--	--	--	--
Clear output buffer	yes	yes	yes	--	--	--
Clear Service Request	yes	1)	2)	--	3)	--
Reset command processing and input buffer	yes	yes	yes	--	--	--

1) Yes, but "Service Request on Power On" is possible.

2) Yes, if only conditioned by a message in the output buffer.

3) Yes, if not conditioned by a message in the output buffer.

3.3.7 Command Processing Sequence and Synchronization

The commands received by the ESVD are first stored in an input buffer which can accommodate up to 4096 characters. Once the terminator has been received, the commands are processed in the sequence in which they were sent. During this time, the IEC bus can be used for communication with other devices. Command lines which exceed the capacity of the input buffer are processed in several sections. The bus is occupied during this time.

The commands *OPC and *OPC? (operation complete) are used as feedbacks to inform on the time at which processing of the received commands was terminated and a scan (if any) has been completely executed.

*OPC sets bit 0 in the Event Status register, and a Service Request can then be enabled if all previous commands have been executed.

*OPC? additionally provides a message in the output buffer and sets bit 4 (MAV) in the status byte.

This synchronization can be established within a command line by the command *WAI, i.e. all subsequent commands are only executed when the previous commands have been completely executed.

3.3.8 Output of Measurement Results via IEC Bus

a) Single Measurements

The result of a single measurement is provided following a request by one of the device-specific commands LEVEL?, LEVEL:LASTVALUE? or LEVEL:CONTINUE?. The latter is especially suited for time-critical applications since the value of the last measurement can be read in immediately using an IEC bus command and the controller can subsequently process this measured value while the test receiver is already performing a new level measurement. The availability of the measurement result in the output buffer is indicated by setting the MAV-bit (message available) in the Event Status register. If the associated mask register has been configured appropriately, a Service Request is thus enabled. (Program example cf. section 3.5).

The data can be output in binary or ASCII format. Selection is effected by the commands LEVEL:FORMAT BINARY or LEVEL:FORMAT ASCII. Binary output is made with 2 byte where the measured value was multiplied by 100 to obtain an integer. Resolution is 0.01 dB and the output in ASCII format is performed correspondingly e.g. with the header LEVEL 12.56

With a double measurement mode set the measured value of the second detector is also output. In ASCII format the value is separated from the first value by a decimal point, e.g. LEVEL 12.56,7.98. In binary format two more bytes are added without using any separators.

The associated header can be switched on and off using the commands HEADER ON and HEADER OFF.

The validity of a measured value is indicated via the extended status register ERC. The individual bits indicate exceedings of the display range or overload of the test receiver. The low-order byte (bits 0-7) is used for detector 1. The high-order byte (bits 8-15) for detector 2 in the case of double measurement modes. If only one detector is switched on, the low-order byte is used.

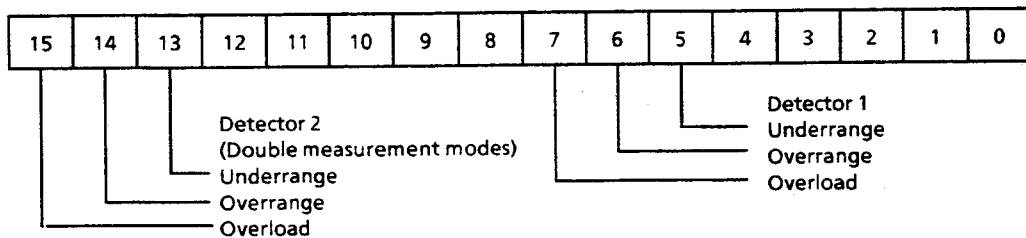

Fig. 3-37 Assignment of the Event Register ERC

The conditions overload, overrange and underrange can be used for generating a Service Request by setting a suitable bit in the associated Enable register ERCE and bit 3 in the Service Request Enable register.

b) Scan

For output of the scan results various formats are available. If complete information on each test point is desired, it is possible to output with each frequency the appertaining level values, a status word, the appertaining transducer factor, if switched on, one or two limit values at the respective frequency and a limit value byte providing information on whether the limit value(s) have been exceeded. The command "SCAN:BLOCK:ELEMENT COMBINED" serves to select this output form.

"SCAN:BLOCK:ELEMENT TRACE" serves to output only the highest level values of the 400 scan subranges. They correspond to the values contained in a test report output on printer or plotter. They are suited for graphical representation of the measurement results without loading the evaluation program and test receiver with the transmission and evaluation of unnecessary data.

"SCAN:BLOCK:ELEMENT SUBRMAX" is used to select a similar format. However only the number of subrange maxima defined by the user by way of the command "SCAN:OPTION:SUBRANGES n" is output.

If the scan is performed with the final measurement option switched on, the results of the final measurements can be accessed using the command "SCAN:BLOCK:ELEMENT FINALRES".

The block elements stated above can be further distinguished by output in binary format and in ASCII format. The commands "SCAN:BLOCK:FORMAT BINARY" and "SCAN:BLOCK:FORMAT ASCII" serve to select between the formats. Please note that in ASCII format the length of a block element may reach more than twice the size of an element in binary format and that internal data processing takes longer than with binary format.

Another form is the unformatted output described below. Three more types of block elements are available for this kind of output.

The table provides an overview on the assignment of the possible block elements to the formats:

	ASCII	BINARY	DUMP
COMBINED	✓	✓	
TRACE	✓	✓	
SUBRMAX	✓	✓	
FINALRES	✓	✓	
DET1			✓
DET2			✓
VALID			✓

To ensure that data transmission is as fast as possible and the scan is not slowed down by unnecessary IEC bus traffic, the scan measurement results are output in the form of blocks. The block size can be selected by the user using the command "SCAN:BLOCK:COUNT value" where "value" is the number of individual measurements that can be transmitted together. The output of measurement values is suppressed during a scan using SCAN:BLOCK:COUNT 0. The number of blocks is calculated automatically depending on the output buffer size after having programmed SCAN:BLOCK:COUNT MAX.

SCAN:BLOCK:COUNT SUBRANGE is used to set the number of values to be transmitted such that the "measured value ready" bits (see below) are set only when a complete subrange is ready. In case the number of data appertaining to a subrange exceed the size of the output buffer transmission must be performed in sections. Bit 3 in the extended Event Register ERD is set to indicate complete transmission of a subrange.

During a scan the measurement values are stored internally until the selected block size is reached or the output buffer is filled. In this case bit 7 in the Event register ERD is set. This in turn triggers a Service Request of the receiver, if bit 7 in the Event Enable register ERDE is set. The stored results can then be requested using the command SCAN:BLOCK?. The measurement values collected are transmitted at one go.

Please note, that block size and format must be defined prior to the start of RF analysis.

Even after having terminated a scan that was carried out in the Local or Remote status, it is possible to poll once the scan measurement results.

Output is caused by the command `SCAN:BLOCK?` where the command can be repeated until all the data are read out. The data are output consecutively.

Depending on the measurement mode and the use of transducer factors and limit lines a single measurement requires a different amount of space in the output buffer. The elements of the data blocks can be polled using `SCAN:BLOCK:TEMPLATE?`. A word the respective bits of which represent the components of a block element is returned.

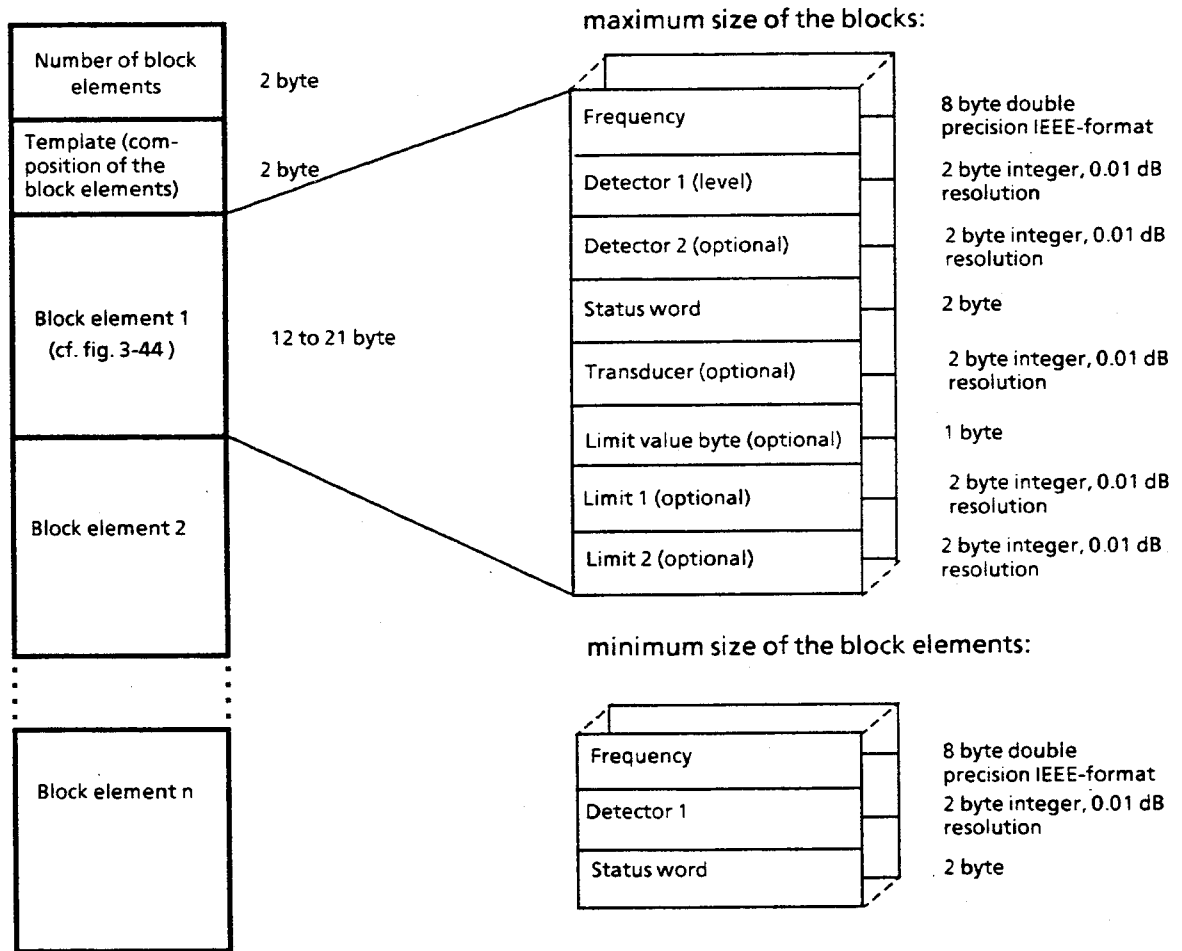

Fig. 3-43 Composition of a data block in binary format

Fig. 3-44 Examples of block elements in binary format

If a bit has the value 1, the respective element is contained in the data block.

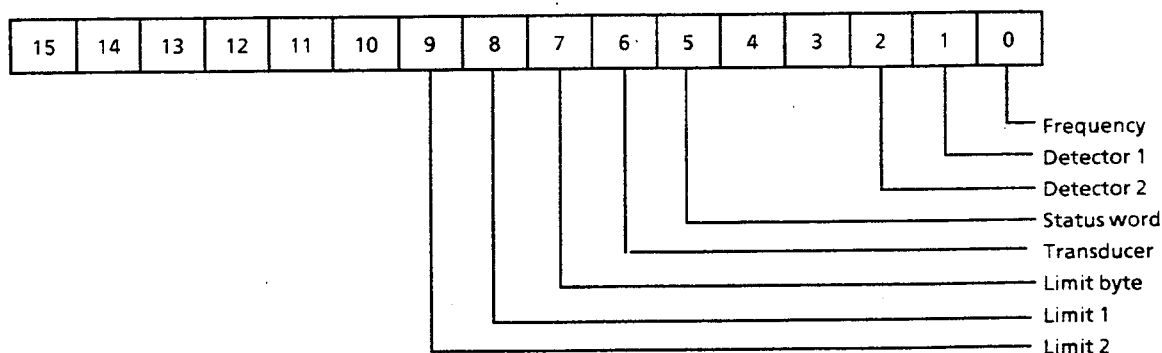

Fig. 3-45 Format of the template word

ASCII format of the block elements:

Frequency,detector1[,detector2],status word[,transducer][,limit byte][,limit 1] [,limit 2]

The frequency is transmitted in the basic unit Hz, level (detector(s), transducer and limits) in dB with a resolution of 0.01 dB and the status word as well as the limit byte as decimal values.

The format of the status word corresponds to the extended Event register ERC.

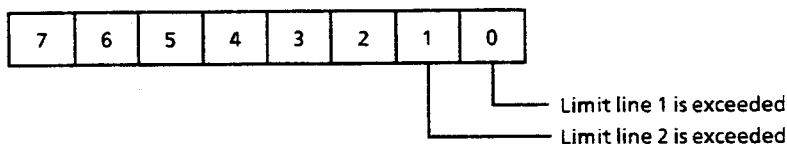
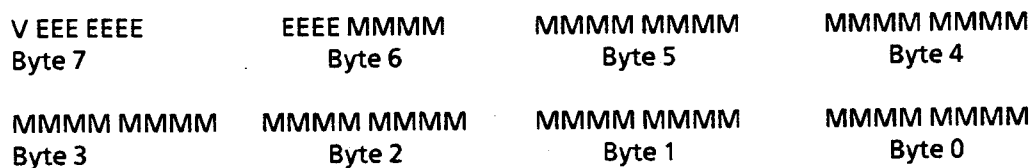

Fig. 3-46 Format of the limit byte

IEEE-number format for floating decimal point variables (Double precision for frequencies):



V = 1 bit sign, E = 11 bit exponent, M = 52 bit mantissa

The sign bit 1 means a negative number, 0 a positive number.

The exponent in the E-field is specified as a complement on two to the basic value 1024.

The mantissa is normalized, i.e. MSB is always assumed to be "1". An effective precision of 53 bit is thus achieved.

The decimal value is obtained by multiplying the mantissa by $2^{-(E-1023)}$. Make sure that the MSB of the mantissa is 1 at any rate, i.e. the value of the mantissa may only be higher than or equal to 1 and lower than 2.

The bytes are always arranged in increasing order.

For applications requiring the data to be made ready for use as fast as possible the results of RF analysis can be output unformatted.

"SCAN:BLOCK:FORMAT DUMP" serves to select this type of output.

The data are transferred in the form they are present in the internal measured value memory of the ESVD. Each value is represented in the data block by a 2-byte integer number with a resolution of 0.01 dB in binary format. The results are arranged in increasing sequence. Since the receiver frequencies are not output, assignment of the level values to the frequencies must be performed using the start and stop frequencies and step widths of the scan data set.

With a double detector selected, the level values of the second detector are stored internally in a separate measured value memory. This applies also to the validity bytes which are contained in another memory and are arranged in increasing sequence.

Since the data can be transferred directly from the measured value memory, only one of the three types of results can be output. The command "SCAN:BLOCK:ELEMENT DET1" is used to select detector 1, "SCAN:BLOCK:ELEMENT DET2" detector 2 and "SCAN:BLOCK:ELEMENT VALID" the validity byte, respectively.

The number of measured values transferred in one block can also be defined using the command "SCAN:BLOCK:COUNT n". With the number set to the value 0, output is not performed during analysis. Please note in this case that the maximum size a block can reach is not limited by the size of the output buffer, which is 4096 bytes. The limit is however 60,000 bytes as each of the measured value memories has a capacity of 30,000 values each represented by 2 bytes.

Since the output is not performed via the output buffer the command "SCAN:BLOCK?" must not be combined with other polling commands with unformatted output being selected.

As a rule, no header is output.

Users of R&S-BASIC must observe that a string can achieve a maximum length of 32 kbytes. For this reason a maximum of approx. 16,000 values each represented by two bytes can be transferred at one time.

With a corresponding amount of measured values being ready to be fetched a message is given by bits set in the extended Event Register ERD.

Results from detector 1 are indicated by bit 7, results from detector 2 by bit 6 and the validity byte by setting bit 5, respectively. This assignment allows to use a universal program routine during the evaluation of the ERD register contents.

The mechanism of data transfer is not affected by how far RF analysis has proceeded. Even with the scan already terminated the availability of measured values not yet fetched is indicated by repeated setting of the appropriate bits in the ERD register.

Scans providing more results than the measured value memory with a storage capacity of 30,000 values can accept are exceptions. With its capacity exhausted, the measured values are stored in a temporary buffer. If the latter is also fully used, or the configured number of measured values per block is reached, RF analysis can only be continued after all results, i. e. from detector 1, or, as the case may be, from detector 2 and the validity byte have been read out.

3.3.9 Transfer of the IEC Bus Controller Function

The ESVD must be able to activate the control line ATN (Attention) so that it is possible to send commands to other IEC bus devices. Only the active IEC bus controller (Controller in Charge) is entitled to do so. The ESVD needs to be Controller in Charge in order to program IEC bus controlled plotters and thus output test reports.

The test receiver can obtain the controller function in the following ways:

1. **There is no process controller connected to the IEC bus.**

This is recognized by the ATN-line and is usually the case when the ESVD operates in the Stand-Alone mode.

The ESVD can then configure itself as IEC bus controller and end the controller function following completed plotter output (Release Control).

2. **A process controller is IEC bus controller.**

This is always true, when the ESVD is controlled by a controller connected to the IEC bus.

In this case IEC bus control is transferred to the test receiver via talker addressing and passed back to the controller after plotter output has been terminated ("Pass Control Back").

3.3.10 Operating Modes for Fast Level Measurement and Triggered Scan

For measurement spheres requiring very high measurement rates of several hundred measured values per second two test modes have been implemented; they can be programed exclusively via IEC bus and the resulting measured values are also output via IEC bus only.

Function principles of these operating modes:

External trigger:

The individual measurements are induced via an external trigger signal. This corresponds to the special functions 51 and 52: external trigger, positive and negative edge. Information on trigger input and level conditions can be obtained from section 3.2.3.13, Special Functions.

The ESVD responds to the pulse edge that was previously set using the respective special function.

Measured value output:

After a trigger pulse the result of the preceding level measurement is output, i.e. the first measured value output follows only after the second trigger pulse. The reason is that a measured value is transmitted via IEC bus during the following measurement cycle. Interleaving allows considerable reduction of the total time required for the test procedure. To obtain an optimum measurement rate the user should ensure that the controller can accept the measured value transmitted with two bytes within the cycle time. Otherwise total measuring time would be correspondingly higher as a result of the delay in IEC bus traffic.

On the process controller side the data appear in a long string since the controller is always addressed as Listener in this operating mode. It is therefore useful to read in the measurement results byte for byte. When employing the control program R&S-BASIC, the command IEC%IN with which one byte respectively can be read is suitable for this purpose.

Each measurement result consists of two bytes, the lower-order byte being transmitted first. The data contain the measured level in binary format with a resolution of 0.01 dB, i.e. a value of 3845 corresponds to 38.45 dB. Provided that a transducer factor has been selected at the coding socket, it is contained in the measurement result. The selected unit - dB μ V oder dBm - is also considered. Transducer factors that may be defined are not part of the result.

Transfer of the Controller Function

For transmission of measured values IEC bus control must be temporarily passed to the ESVD by the process controller, the actual system controller. The ESVD is thus able to transmit the two bytes representing the measurement result without permanent addressing and deaddressing of the process controller so that the measured values can be output more rapidly.

If the ESVD operated as Talker/Listener, each data output would have to be enabled by the process controller (acc. to IEC/IEEE standard) using a query. The time required would be increased considerably both on process controller and on test receiver side.

To start one of these operating modes the ESVD must be programed by an appropriate command, e.g. SCAN:OPTION:TRIGGERSCAN. The controller function must now be passed to the ESVD by the process controller. In R&S-BASIC this is performed using the commands IECTAD ESVD address and IECTCT. The IEC bus address of the process controller must have been set as Pass Control Back address in the ESVD using the command *PCB (cf. table 3-21). After that the ESVD itself sets internally the selected operating mode and addresses the process controller as Listener in order to initiate the transmission of data.

From now on the ESVD responds to trigger pulses.

Ending the Operating Mode:

To end this operating mode the process controller must send a Service Request to the ESVD. Since the ESVD in the addressed state cannot detect which device sent the Service Request, a further Request that may even originate from another IEC bus device leads definitely to the end of this operating mode. During this procedure the process controller is deaddressed while the controller function is passed back. The controller function must then be accepted by the process controller, e. g. using the R&S-BASIC command IECWTCT.

If with the selected measuring instruments configuration a Service Request can also be triggered by other devices, this case must be taken into account in the control program.

Caution! *The Service Request must not be triggered with the ESVD currently performing a measurement cycle during which a measurement result is output via IEC bus!*

Fast Level Measurement (Special Function 53)

All level measurements are carried out on the set receive frequency. The quasi-peak detector is switched to peak. The command "SPECIALFUNC:FASTLEVEL" is used to select this operating mode.

Sampling time can be programed using the command "SPECIALFUNC:SAMPLINGTIME". It may be within the range of 100 μ s to 32 ms. Default setting is 100 μ s.

The result of the previous measurement is output during the sampling time for the subsequent measurement. To obtain a maximum measurement rate, the controller must be able to accept the measured value within the set sampling time.

Total cycle time of a measurement is determined by the sampling time and a time required for internal processes, provided that the process controller meets the requirements stated above.

Internal processes take about 0.2 ms with auto ranging being activated and approx. 0.1 ms, respectively without auto ranging.

The following measurement rates in measurements/second can be achieved with the use of a controller that is able to accept quickly enough the transferred data:

Auto ranging off	> 5000
Auto ranging on	> 3000

Triggered Scan (Option 80)

This operating mode is configured using the command `SCAN:OPTION:TRIGGERSCAN`. As opposed to the level measurement described above, previously programmed frequencies are set in the case of the triggered scan. The IEC bus command `SCAN:OPTION:FREQUENCIES`, which is also used for option 63, Special Scan, serves for this purpose. The receive frequency is switched cyclically on each trigger pulse. The first 20 frequencies at best are taken into consideration. All the receive frequencies must however be within certain frequency ranges in order to keep the settling times as low as possible.

The frequency ranges (in MHz) are:

Frequency ranges [MHz]	Frequency ranges [MHz]
20 to < 51.3	495.3 to < 569.3
51.3 to < 125.3	569.3 to < 643.3
125.3 to < 199.3	643.3 to < 717.3
199.3 to < 273.3	717.3 to < 791.3
273.3 to < 347.3	791.3 to < 865.3
347.3 to < 421.3	865.3 to < 889.3
421.3 to < 495.3	889.3 to 1000

Frequency ranges of the ESVD-B2 option

Frequency ranges [MHz]	Frequency ranges [MHz]
1000.0001 to < 1026	1522 to < 1600
1026 to < 1101	1600 to < 1690
1101 to < 1176	1690 to < 1760
1176 to < 1250	1760 to < 1795
1250 to < 1320	1795 to < 1890
1320 to < 1395	1890 to < 1950
1395 to < 1470	1950 to < 2005
1470 to < 1522	2005 to < 2050

Frequency data sets not completely within one of the ranges specified above are not considered.

Sampling time can be programmed using the command `"SCAN:OPTION:SAMPLINGTIME"`. It must be more than 100 μ s. Default setting is 100 μ s.

In this operating mode the time the ESVD waits before a measurement to compensate for synthesizer and filter settling times can be set in addition to the sampling time.

The command "SCAN:OPTION:SETTLINGTIME" is used to set this waiting time. The minimum settable time is 1 ms, default setting is 2.2 ms.

A table giving the recommended waiting times is contained in section 3.2.4.3.3 (Options).

Waiting time and sampling time together must not be more than 32 ms!

With the triggered scan - as with the fast level measurement - only the level values are output for reasons of speed. The level values can be easily assigned to the respectively set frequency by the control program via the number of transferred bytes.

Measured value output is performed via IEC bus during the settling time. To avoid violation of the set time grid, the process controller must be able to accept the measurement data within a time window (settling time - 0.3 ms)..

The time of 0.3 ms is required for computing the level value, programming the synthesizer, auto ranging, etc.

Total cycle time is defined by adding the settling time to the sampling time plus a time of about 0.1 ms required for internal processes.

A maximum measurement rate of slightly over 400 measurements/second can thus be achieved with, for example, a settling time of 2.2 ms and a sampling time of 0.15 ms.

Program Example of a Fast Level Measurement

The measurements are performed with a frequency of 950 MHz using a peak value detector. The 60-dB operating range and auto ranging are switched on.

With the special function 51 switched on the ESVD responds to the rising edge of the trigger signal.

An external source or a programmable TTL I/O card, which can be obtained as options for the R&S-controllers PCA and PSA, can be used for generating the trigger pulses.

The trigger pulses can be provided by a position transducer as is the case with a typical application, which is recording of fieldstrength patterns in mobile use.

The measurement results are read in byte for byte, converted into a floating decimal point number with correct signs and finally output.

The measurements are ended simply by pressing any key on the process controller.

Note: *This example serves to illustrate the function principle. It is not designed to achieve an optimum measurement rate.*

```
1000 '
1010 ' Set ESVD to fast level measurement.
1020 ' Do repeated measurements until a key will be pressed.
1030 '
1040 '
1050 '
1060 Esvd%=20: ' IEC address of ESVD
1070 '
1080 IEC ADR 30: ' IEC address of controller
1090 '
1100 '
1110 IEC OUT Esvd%,"*CLS": ' clear register
1120 IEC OUT Esvd%,"*PCB 30": ' set address for Pass Control Back
1130 ' to controller address
1140 '
1150 ' Set Receiver Settings: Frequency, Detector, Measurement Time etc.
1160 '
1170 IEC OUT Esvd%,"FREQUENCY 900 MHZ; DETECTOR PEAK"
1180 IEC OUT Esvd%,"MEASUREMENT:TIME 1 MS"
1190 IEC OUT Esvd%,"ATTENUATION 10 DB; ATTENUATION:AUTO ON"
1200 IEC OUT Esvd%,"ATTENUATION:MODE LOWNOISE"
1210 IEC OUT Esvd%,"RANGE 60 DB"
1220 IEC OUT Esvd%,"SPECIALFUNC:SAMPLINGTIME 0.1 MS"
1230 IEC OUT Esvd%,"SPECIALFUNC:FASTLEV": ' start fast level measurement.
1240 '
1250 IEC TAD Esvd%,TCT : ' pass control to ESVD
1260 '
1270 IEC TERM 1: ' terminator for binary data is EOI
1280 IEC TIME 0: ' infinite timeout
1290 '
1300 IEC WMLA : ' wait for my own address
1310 PRINT "Listener!"
1320 '
1330 ' The ESVD is now waiting for an external trigger impulse.
1340 ' This may be generated by a TTL I/O interface or any other source.
1350 ' The first trigger does only a level measurement and is not
1360 ' sending a result via IEC bus!
1370 '
2000 WHILE (NOT Escape)
2010 '
2020 ' At this point - inside the loop - repeated trigger impulses
2030 ' should be given.
2040 ' These impulses are causing an output of the last measured
2050 ' value to the IEC bus before doing the next measurement.
2060 '
```

```

2070 IEC %IN Lev_lower%: '      get lower byte of level value
2080 IEC %IN Lev_upper%: '      get higher byte of level value
2090 Level%=Lev_upper%*256+Lev_lower%: ' unsigned value
2100 Lev=Level%/100: '          calculate floating point value
2110 PRINT Lev: '               print level value
2120 '
2130 INKEY Xy$: '               check keyboard
2140 IF Xy$<>" THEN: '         user request
2150   IEC RQS 96: '           pull SRQ line
2160 '
2170 '   ESVD will respond to SRQ:
2180 '   sending UNLISTEN to controller
2190 '   terminating FASTLEVEL mode
2200 '   passing control back to system controller
2210 '
2220   IEC WTCT : '             wait for take control
2230   PRINT "Received Control back": ' print this message
2240 '
2250   Escape=NOT 0: '         set flag to leave loop
2260   ENDIF
2270 WEND
2280 END

```

Program Example of a Triggered Scan:

Measurements are made at ten frequencies between 950 MHz and 953.6 MHz. In this case, too, the peak value detector, 60-dB operating range and auto ranging are switched on.

Apart from the measured level value the appertaining frequency is also output by the control program.

In this example, too the measurements can be terminated simply by pressing any key on the process controller.

```
1000 '
1010 ' Set ESVD to fast scan measurement.
1020 ' Do repeated measurements until a key will be pressed.
1030 '
1040 '
1050 '
1060 Esvd%=20: ' IEC address of ESVD
1070 '
1080 IEC ADR 30: ' IEC address of controller
1090 '
1100 '
1110 IEC OUT Esvd%,"*CLS": ' clear register
1120 IEC OUT Esvd%,"*PCB 30": ' set address for Pass Control
1130 ' Back to controller address
1140 '
1150 ' Set Receiver Settings: Detector, Measurement Time etc.
1160 '
1170 IEC OUT Esvd%,"DETECTOR PEAK"
1180 IEC OUT Esvd%,"MEASUREMENT:TIME 1 MS"
1190 IEC OUT Esvd%,"ATTENUATION 10 DB; ATTENUATION:AUTO ON"
1200 IEC OUT Esvd%,"ATTENUATION:MODE LOWNOISE"
1210 IEC OUT Esvd%,"RANGE 60 DB"
1220 IEC OUT Esvd%,"SCAN:OPTION:SETTLINGTIME 2.3 MS"
1230 IEC OUT Esvd%,"SCAN:OPTION:SAMPLINGTIME 0.1 MS"
1240 '
1250 ' Frequencies for fast scan measurement
1260 '
1270 DIM Freq(10)
1280 Freq(0)=950.0E6
1290 Freq(1)=950.4E6
1300 Freq(2)=950.8E6
1310 Freq(3)=951.2E6
1320 Freq(4)=951.6E6
1330 Freq(5)=952.0E6
1340 Freq(6)=952.4E6
1350 Freq(7)=952.8E6
1360 Freq(8)=953.2E6
1370 Freq(9)=953.6E6
1380 '
1390 ' Program frequencies to ESVD
1400 '
1410 Z$="SCAN:OPTION:FREQUENCIES 10,"
1420 '
1430 FOR I=0 TO 8
1440 Z$=Z$+STR$(Freq(I))+",": ' without terminator
1450 NEXT I: ' , is data separator
1460 '
1470 Z$=Z$+STR$(Freq(9)): ' last value with terminator
1480 IEC OUT Esvd%,Z$
1490 '
1500 ' Initialize frequency index
1510 Index%=0
1520 '
1530 IEC OUT Esvd%,"SCAN:OPTION:TRIGGERSCAN": ' start triggered scan
1540 '
1550 IEC TAD Esvd%,TCT : ' pass control to ESVD
1560 '
1570 IEC TERM 1: ' terminator is EOI
```

```

1580 IEC TIME 0: ' infinite timeout
1590 '
1600 IEC WMLA : ' wait for my listener address
1610 PRINT "Listener!"
1620 '
1630 ' The ESVD is now waiting for an external trigger impulse.
1640 ' This may be generated by a TTL I/O interface or any other source.
1650 ' The first trigger does only a level measurement and is not
1660 ' sending a result via IEC bus!
1670 '
2000 WHILE (NOT Escape)
2010 '
2020 ' At this point - inside the loop - repeated trigger impulses
2030 ' should be given.
2040 ' These impulses are causing an output of the last measured
2050 ' value to the IEC bus before doing the next measurement.
2060 ' With each impulse the next frequency is selected.
2070 '
2080 IEC %IN Lev_lower%: ' get lower byte of level value
2090 IEC %IN Lev_upper%: ' get higher byte of level value
2100 Level%=Lev_upper%*256+Lev_lower%: ' unsigned value
2110 Lev=Level%/100: ' calculate floating point value
2120 PRINT Freq(Index%): ' print frequency
2130 PRINT Lev: ' print level value
2140 '
2150 ' set index to next frequency
2160 '
2170 Index%=Index%+1
2180 IF Index%>9 THEN Index%=0
2190 '
2200 INKEY Xy$: ' check keyboard
2210 IF Xy$<>" " THEN: ' user request
2220 IEC RQS 96: ' pull SRQ line
2230 '
2240 ' ESVD will respond to SRQ:
2250 ' sending UNLISTEN to controller
2260 ' terminating FASTSCAN mode
2270 ' passing control back to system controller
2280 '
2290 IEC WTCT : ' wait for take control
2300 PRINT "Received Control back": ' print this message
2310 '
2320 Escape=NOT 0: ' set flag to leave loop
2330 ENDIF
2340 WEND
2350 END ...

```

3.3.11 Error Handling

Errors that are detected in connection with IEC bus operation are indicated by setting a bit in the Event Status register. These are bit 2 for a query error, bit 4 for an execution error and bit 5 for command error. Device-specific errors are signaled by setting bit 3 (device-dependent error).

These bits remain set until the Event Status register is read out or cleared by the commands *RST or *CLS. A Service Request can thus be enabled and the type of error can be evaluated by way of program control.

A more detailed error message can be obtained by way of the command SYSTEM:ERRORS?. A decimal value is output, which can be interpreted in accordance with table 3-31.

Table 3-32 Error messages

0	no error
-100	internal error
-101	syntax not correct
-102	wrong data type
-113	unknown command or command not clear
-130	wrong or unclear unit
-141	wrong or unclear character data
-161	illegal block data
-221	input not allowed
-222	date is out of the permissible range, if not already specified by error message >0
-400	overflow of output buffer
-410	output data were not read and overwritten
-420	no output data available during the attempt to read them
3	setting not allowed in this connection
4	date is out of permissible range
9	unit not correct
16	minimum frequency exceeded (e.g. transducer factors)
17	maximum frequency exceeded
18	minimum level exceeded
19	maximum level exceeded
20	wrong order of frequency values
100	no scan defined during the attempt to program scan data

3.4 Applications

The *options* of the RF analysis serve to specify the measurement sequences that are optimal for the different applications of the ESVD. The options are divided into groups and some of them can be combined with each other.

The semi-automatic measurement sequences described below can be applied when the interference is stable within the measuring time. Manual measurement is recommended to be used for intermittent, quickly drifting and cyclic interferences with long cycle times.

The most important criteria of automatic measurement are

- time-efficiency
- high reliability and accuracy
- reproducibility of results
- automatic and complete display of results

RFI measurements sometimes are very time-consuming due to the time-constants specified by the standard for quasi-peak weighting which cause settling procedures requiring long measuring times for each measured value. The standards furthermore prescribe search procedures to determine the interference radiation maxima such as shifting the absorbing clamp, varying the height of the measuring antenna or turning the device under test in another direction. Thus, performing measurements including quasi-peak weighting for each frequency and each setting of the measurement configuration would lead to unacceptably long measuring times. Therefore, R&S developed a system reducing the time-consuming measurement procedures to a minimum while providing high reliability concerning the acquisition of measured values.

The interference spectrum is first analyzed to optimize the measurement sequence as to time. Data reduction is subsequently performed so that a final measurement must be carried out at few frequencies only.

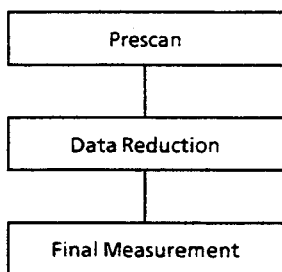

The data reduction is of decisive importance. Option 30 is used for this purpose (subrange maxima and acceptance analysis):

```
DATA INPUT
OPT 30 SUBRGE/MARGIN
Default ON
> No. of Subranges: 25
Acc Margin/dB: 6
```

Frequencies with especially high interference levels can be determined already during prescan with the help of option 30. It implies two methods for data reduction:

- Determination of subrange maxima, i.e. the interference spectrum is only further examined at those frequencies with the highest interference levels within one frequency subrange. The entire frequency range is divided up into up to 400 subranges. A subrange maximum is determined for each subrange during the prescan.
- Acceptance analysis, i.e., the interference spectrum is only further examined at those frequencies with levels exceeding a line which is parallel to the limit value line. Thus, measuring frequencies with the noise levels being far below the limit value is no longer necessary. The safety margin between the assumed acceptance line and the limit line is freely definable by the user as Acceptance Margin.

Two values have therefore to be specified:

- the number of *subranges* (a value out of 8, 16, 25, 50, 100, 200, 400; default value: 25)
- the *acceptance margin* (Acc. Margin/dB; default value: 6 dB). This applies to each of two limit lines.

A menu for selecting and entering these values is displayed when calling the option 30. Upon pressing the → key, the cursor is located at the line >Default..., if the default values have not yet been set, otherwise the cursor is set to the number of *subranges*. If *Default* is set to *OFF*, the default values can be activated by pressing the ENTER key. The cursor can be moved to the desired line using the ↑ ↓ keys. The values for *No of Subrges* and *ACC Margin/dB* can be set using the numeric keys and are accepted by way of ENTER. Both, switching on the option and changing the values can also be performed after the prescan has been executed, since 400 subrange maxima are always stored.

Options 40 to 45 serve to specify the detectors for the final measurement at the frequencies determined during the data reduction. If none of the options 40 to 45 is switched on, a final measurement is not performed.

Option 62 defines that the interference spectrum is output via the plotter simultaneously with the measurement.

When the option 63 (Special Scan) is selected, entering <RUN> does not lead to a scan according to the RF analysis data set but only to scanning the frequencies of a frequency list entered by means of this option or the frequencies of a list resulting from the data reduction.

Calling the options (cf. section 3.2.4.3.3):

- ▶ Press the OPTIONS key.
The options are listed on the DATA INPUT display:

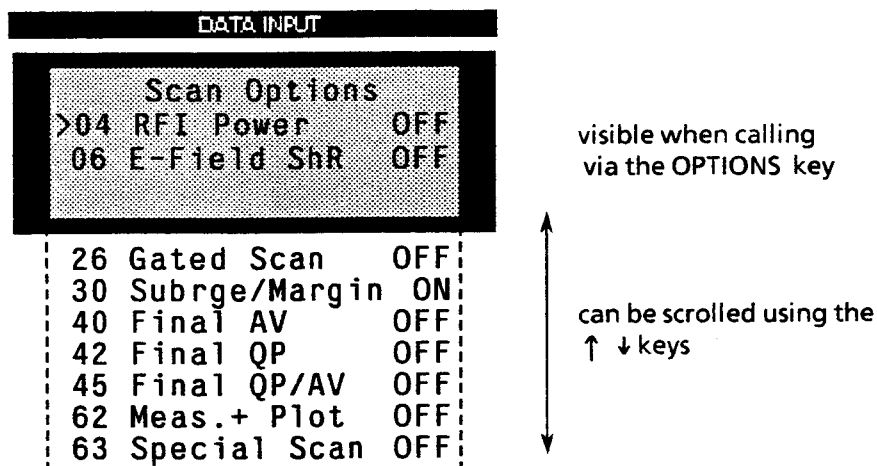

The options 04 and 06 are used for defining the measuring configurations for the different applications of the EMI Test Receiver ESVD 10:

- Option 04 for RFI power measurement using the absorbing clamp and
- Option 06 for RFI fieldstrength measurement.

RFI voltage and RFI current measurements can be performed in the range from 30 MHz without using any specific option.

3.4.1 Measuring the RFI Voltage or the RFI Current

According to commercial standards RFI voltage measurements are usually performed in the frequency range above 30 MHz using either artificial networks for this frequency range or directly at the car antenna according to VDE 0879 Part 2 (draft). Probes such as the R&S probes ESH2-Z2 and ESH2-Z3 are generally not used above 30 MHz.

The R&S accessories listed below can be used for RFI voltage measurements above 30 MHz:

- T-network ESH3-Z4
- 4-wire-T-network EZ-10
- V-network 5I/H//50 Ω ESH2-Z6

The V-networks are used to test V-terminal voltages whereas the T-networks are suitable for asymmetrical ones. RFI voltage measurements are generally carried out at frequencies within the range from 9 to 30 MHz according to national and international standards. The frequency range for RFI voltage measurements at car accessories, however, extends from 150 kHz to 108 MHz. The ESVD is thus only suitable for these measurements to a limited extent.

For detailed information on which artificial mains networks to be used or on the required test setups refer to the latest versions of the standards - CISPR Publications, European Standards, VDE Regulations, FCC Rules & Regulations, VCCI Recommendations, etc.

Though not prescribed by the commercial standards, RFI current measurements using RF current probes such as the ESV-Z1 or EZ-17, are very common when determining interference sources and testing devices for interference suppression.

a) Test Setup

To avoid measurement errors caused by ambient interference the device under test and the measuring sensor (artificial mains network) should be operated inside a shielded room, whereas the test receiver together with printer and plotter should be set up outside.

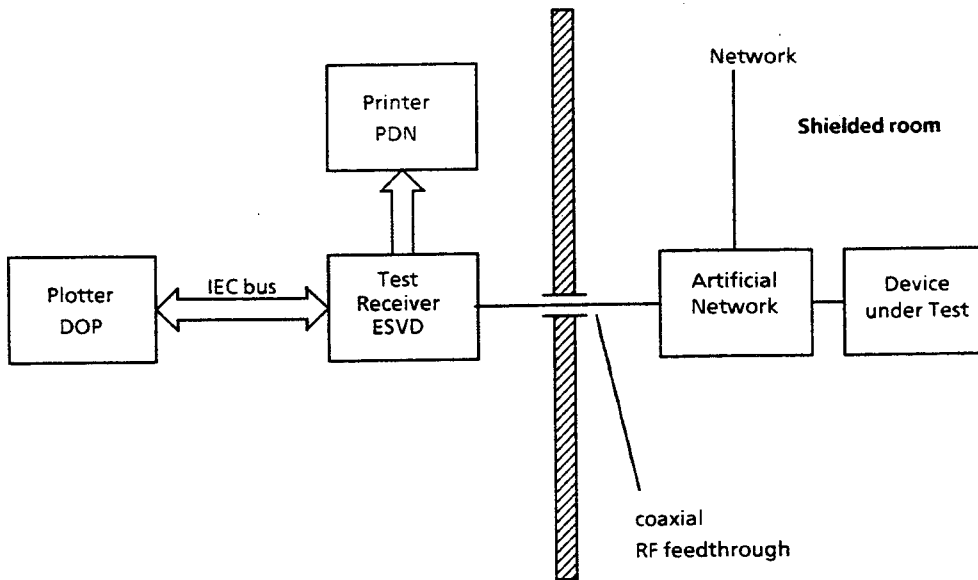

Fig. 3.47 Block diagram of a test setup with artificial network and device under test in a shielded room

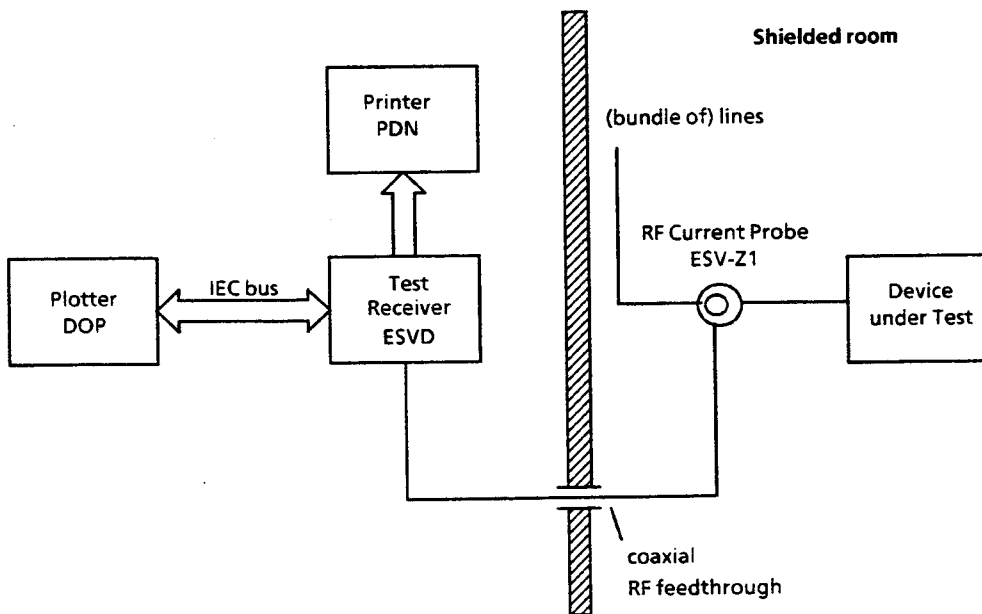

Fig. 3.48 Block diagram of a test setup with RF current probe and device under test in a shielded room

Due to its low interference radiation the test receiver ESVD can be set up inside the shielded room. Simultaneous operation of printer and plotter inside this room may, however, cause problems, if the setup is unfavourable. In this case the test report should be output subsequent to the measurement.

b) Setting of the Test Receiver

The scan setting of the test receiver determines the data of the prescan. For RFI voltage measurements at car accessories, e.g., it covers a range from 0.15 to 108 MHz. The remaining measuring range for the ESVD is then 30 to 108 MHz.

Scan data:	
Frequency range/MHz	30 - 108
Stepsize/kHz	60 ¹⁾
Bandwidth (IF BW)/kHz	120
Detector	PK + AV ²⁾
Meas. Time/s	.02 ³⁾
Attenuation	Auto Low Noise
Operating Range/dB	60

- 1) With pure broadband interference, frequency-proportional step size (LOG step) can be used instead of steps half the bandwidth.
- 2) For measurements according to standards with narrowband and broadband interference limit values or average and quasipeak limit values, the special function 30 allowing for simultaneous measurement of peak and average value during one scan is useful. If there is only one limit value, it is sufficient to switch on one detector only, e.g. Pk or Av.
- 3) The measuring time per measured value is determined by the type of interference signal. It should be selected such that the highest value is recorded in the case of time-dependent variations. Minimum measuring times of 20 or 10 ms are therefore required for network-synchronous pulse interferences (50 Hz or 100 Hz).

The subsequent scan options are suitable for RFI voltage and current measurements:

There is no special option for RFI voltage or current measurements in the range of > 30 MHz. A final measurement is immediately performed at the end of each subrange, if the options 30, 40 to 45 are selected.

Phase selection as is possible with the artificial mains networks ESH2-Z5 and ESH3-Z5 below 30 MHz is not offered.

The conversion factor of the current probe or the insertion loss of the artificial mains network are to be entered via the transducer factor.

- 30 Subrange/Margin is determined as explained in the introduction to section 3.4.
Suitable settings:
No of Subranges 16 or 25
Acc. Margin/dB 10
- 40 The options 40 to 45 determine the type of detector for final measurement.

c) Test Run, Measurement and Analysis Procedure

- ▶ The prescan is initiated by pressing the RUN/STOP key. It can be interrupted by pressing this key once and aborted by pressing the key twice (cf. section 3.2.4.3.4).

At the end of each subrange a final measurement is performed, if one of the options 40 to 45 is selected.

Option 40 Final AV = ON: Final measurement of the RFI voltage (RFI current) within the measuring time defined by option 40, the average detector being at the frequency of the subrange maximum.

Option 42 Final QP = ON: Final measurement of the RFI voltage (RFI current) at the frequency of the subrange maximum within the measuring time defined by option 42. Option 42 automatically switches on the Pk detector during prescan.

Option 45 Final QP/Av = ON: Final measurement of the RFI voltage (RFI current) within the measuring time defined by option 45. This option automatically switches on special function 30 (Pk + Av) during the prescan, i.e., with AV maximum of the subrange the final measurement is carried out using the Av detector, with Pk maximum of the subrange the QP detector is used for final measurement.

Option 62 Meas + Plot = ON: The interference spectrum is output on plotter simultaneously with the measurement.

3.4.2 RFI Power Measurement Using the Absorbing Clamp

According to the standards CISPR 14 and VDE 0875 part 1 the RFI power at the signal and supply lines exceeding a length of 1 m is to be measured within the frequency range 30 to 300 MHz. The absorbing clamp MDS 21 is used for this measurement. It is supplied with the transducer factor for determination of the RFI power in dBpW using the RFI voltage indicated by the test receiver in dBµV. The signal and supply lines are lengthened to approx. 6 m (= half the wavelength at 30 MHz (5m) + length of the clamp). The clamp has to be slid by half the wavelength up to the maximum indication at the test receiver, respectively. Strictly speaking, the complete spectrum would have to be measured at each position (every 10 cm). This would, however, lead to unacceptably long measuring times.

The entire frequency range is divided up into a sufficient amount of subranges instead, featuring nearly the same conditions for all frequencies (i.e., source and load impedances are nearly equal)

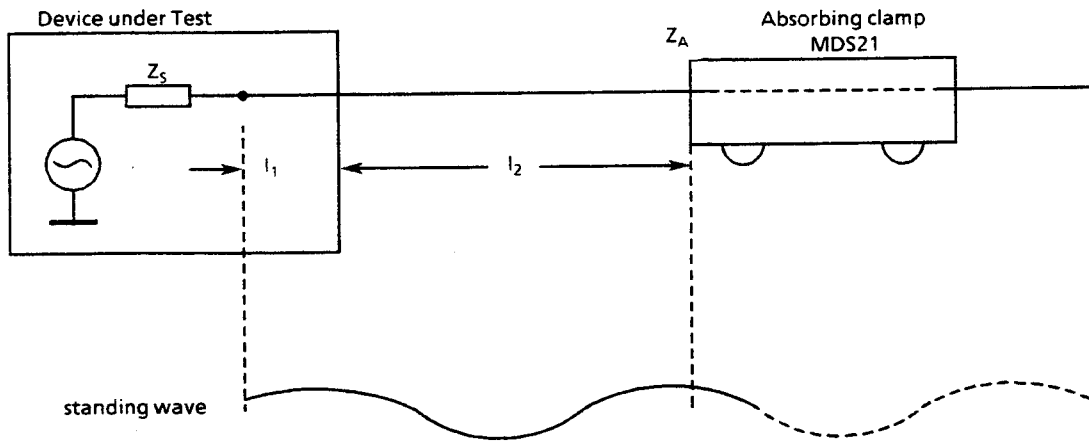

Fig. 3-49 Impedances Z_S and Z_A and lengths of the lines l_1 and l_2 with RFI power measurement. Z_S , Z_A and l_1 are nearly constant within one subrange; it is thus sufficient to determine the local maximum l_2 of the subrange maximum.

It can be assumed that the standing wave of the subrange maximum (maximum level of the subrange spectrum with fixed clamp) has its local maximum (the first maximum occurring with sliding the clamp) at the same location as all the other frequencies of this subrange and that all level relations within the frequency subrange remain nearly constant. That is why it is not necessary to determine the local maximum for each frequency of the subrange, since the levels are always below the level of the local maximum of the frequency subrange maximum. The subrange maximum thus becomes the representative frequency of the frequency subrange.

The current entering into the clamp never becomes 0, since the clamp does not terminate the interference source with a high impedance. That is why the entire spectrum can be covered at one position by an Acceptance Margin of approx. 10 dB - definitively at 0-position. Entering 16 or 25 for the number of subranges, e.g., is sufficient to minimize the amount of errors.

a) Test Setup

To avoid measurement errors due to ambient interference the device under test and the measuring sensor (absorbing clamp) should be operated in a shielded room, however, for example, cellar rooms with low ambient interference are often sufficient. Due to its low radiation the test receiver ESVD can be set up inside the shielded room. Simultaneous operation of a printer and/or plotter may, however, cause problems. In this case the test report should be output subsequent to the measurement or the ESVD together with printer and plotter should be operated outside the shielded room.

It should be possible to move the absorbing clamp at the test receiver. This could be achieved by rollers supporting the clamp and a cord connecting the clamp to the test receiver.

It is useful to mark the measuring table with a frequency scale such that the frequency value is entered at a distance of half the wavelength from the device under test, respectively, i.e., "300 MHz" with 0.5 m; "200 MHz" with 0.75 m; "150 MHz" with 1 m; "100 MHz" with 1.5 m; ... "30 MHz" with 5 m. The operating range of the clamp decreases with increasing frequency.

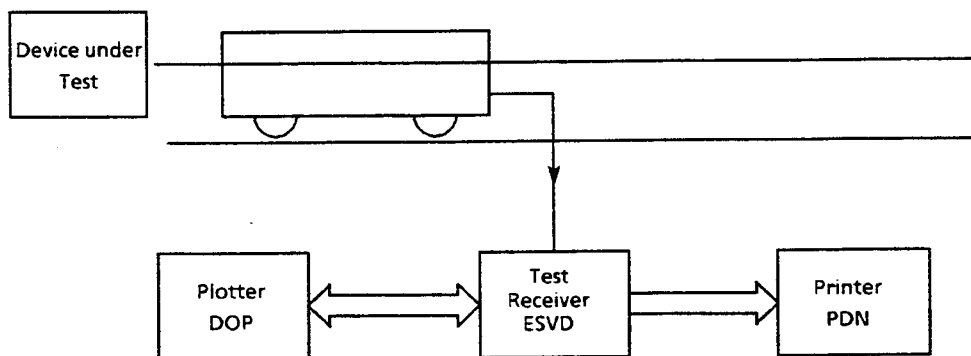

Fig. 3-50 Block diagram of a test setup with MDS clamp and device under test in a shielded room

Detailed information on the height of the measuring table, the distance between MDS clamp and wall etc., can be looked up in the latest versions of the respective standards.

b) Setting of the Test Receiver

The scan setting of the test receiver determines the data of the prescan. For RFI power measurements it covers a range from 30 to 300 MHz.

Scan data:

Frequency range/MHz	30 - 300
Stepsize/kHz	60 1)
Bandwidth (IF BW)/kHz	120
Detector	PK + AV 2)
Meas. Time/s	.02 3)
Attenuation	Auto Low Noise
Operating Range/dB	60

- 1) With pure broadband interference, frequency-proportional step size (LOG step) can be used instead of steps half the bandwidth.
- 2) For measurements according to standards with narrowband and broadband interference limit values or average and quasipeak limit values, the special function 30 allowing for simultaneous measurement of peak and average value during one scan is useful. If there is only one limit value, it is sufficient to switch on one detector only, e.g. Pk or Av.
- 3) The measuring time per measured value is determined by the type of interference signal. It should be selected such that the highest value is recorded in the case of time-dependent variations. Minimum measuring times of 20 or 10 ms are therefore required for network-synchronous pulse interferences (50 Hz or 100 Hz).

The subsequent scan options are used for RFI power measurements:

04 *RFI Power*

RFI power measurement

Enables interactive measurement at the subrange maxima subsequent to the prescan, if one of the options 40 to 45 is selected.

The conversion factor of the MDS clamp is to be entered via the transducer factor.

30 *Subrange/Margin* is determined as explained in the introduction to section 3.4. Suitable settings:

No of Subranges 16 or 25

Acc. Margin/dB 10

40 The options 40 to 45 determine the type of detector for final measurement.

c) Test Run, Measurement and Analysis Procedure

- ▶ Press the RUN key. The following request is read out on the DATA INPUT display:

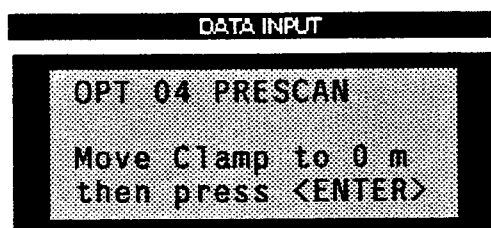

- ▶ Move the clamp as near as possible to the device under test and press one of the ENTER keys. The prescan is started and runs to the stop frequency with determination of the subrange maxima (Pk and/or Av) reading out the message SCAN Running....The interference spectrum can be output on plotter using option 62. The end of the prescan is indicated by a beep, then the first frequency and the detector of one of the options 40 to 45 are set and the following request is output:

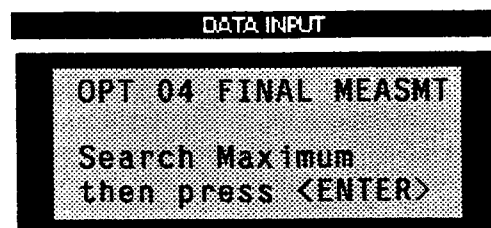

- ▶ Vary the frequency using the rotary knob to trace drifting interferences. The currently set frequency is entered into the list of measuring values. If the same frequency with the same detector (measuring bandwidth) is set twice during the searching procedure the frequency with the lower level is suppressed. Therefore, the list does not contain the same frequency twice.
- ▶ Slide the clamp while watching the pointer of the analog indication until the maximum has been found.
- ▶ The value currently indicated on the LEVEL display is stored in the measured value memory and output on plotter as * or +. Then the ESVD sets the next frequency etc. (It is also possible to perform two measurements at the same frequency, if the AV subrange maximum and the PK subrange maximum with SF 30 are at the same frequency).

- ▶ A list of the measured values can be output on plotter or on printer, as shown by the subsequent example (This table applies for option 45 by way of example. The AV table is not listed, when option 42 is selected. When option 40 is selected the QP table is omitted.):

Frequency MHz	QP Level dBpW	QP Limit dBpW
31.3000	41.4	45.1
37.4500	47.3*	45.7
51.3500	44.5	46.5

Frequency MHz	AV Level dBpW	AV Limit dBpW
34.25	38.3*	35.3
37.45	43.5*	35.7

* limit exceeded

Note: *With option 45 the higher limit is always the QP limit. If no limit value line is activated, the respective column heading is omitted.*

3.4.3 RFI Fieldstrength Measurement

RFI fieldstrength measurements are usually performed at open air test systems in the range from 30 to 1000 MHz at a distance of 3, 10 or 30 m from the device under test. Linear polarized broadband dipoles are used as antennas with horizontal and vertical polarization. Generally, two antennas are used, e.g. a HK116 (30 to 300 MHz) together with a HL 223 (200 to 1000 MHz) or the broadband dipole HUF-Z1 (30 to 80 MHz) together with the log-periodic antenna HL 023 A1 (80 to 1000 MHz).

The fieldstrength measuring systems provide a conductive basal surface and must provide a system attenuation within narrow tolerance limits. There are only few perfect test systems in shielded (absorber) halls, since the required absorbers are quite expensive. Due to the conductive surface the fieldstrength does not only depend on polarization but also on height. Therefore, the antenna must be varied in height between 1 and 4 m. Since the device under test itself emits a directional radiation, it has to be turned in the various directions and, if necessary, be operated at different operating modes and with different cord arrangements. The influence of ambient interferences, which are often intermittent, i.e. not time-constant, on free-field test systems must also be taken into account.

A fully automatic measuring sequence using a test receiver without the aid of a controller is thus not suitable. This is why R&S offers the following solution using the ESVD:

A prescan is performed inside an acceptably shielded absorber hall without varying the height of the antenna (e.g. in the near-field at a distance of 1 m from the device under test) for searching the subrange maxima, which are then stored in the CMOS-RAM for subsequent manual open air measurement. If a semi-anechoic chamber is available, the optimum height should be selected.

a) Test Setup for RFI Fieldstrength Measurement

The device under test together with the antenna are placed in a shielded room, whereas the test receiver with its peripherals should be placed outside. The arrangement of the device under test including all lines connected should be identical with that of the free-field measurement. The antenna should be situated in the main radiation direction of the device under test.

The position of the antenna is recommended to be below 45 degrees (i.e. not horizontal or vertical) for the prescan. In this case one test run is sufficient.

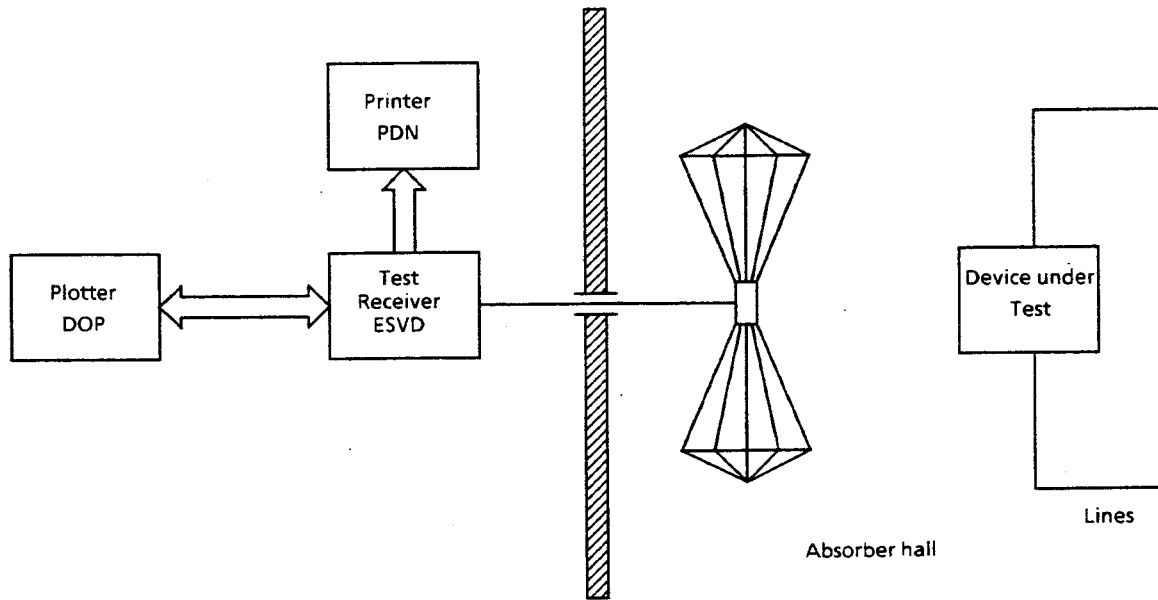

Fig. 3-51 Test setup for RFI fieldstrength measurement in an absorber hall

In the case of free-field measurements, the device under test may be positioned on a manually or remote-controlled turntable. The arrangement of lines to the device under test is to be looked up in the valid testing regulations. The mast of the antenna and the turntable should be controllable at the test receiver location. Make sure that the test system (test receiver and peripherals) are reflection-free.

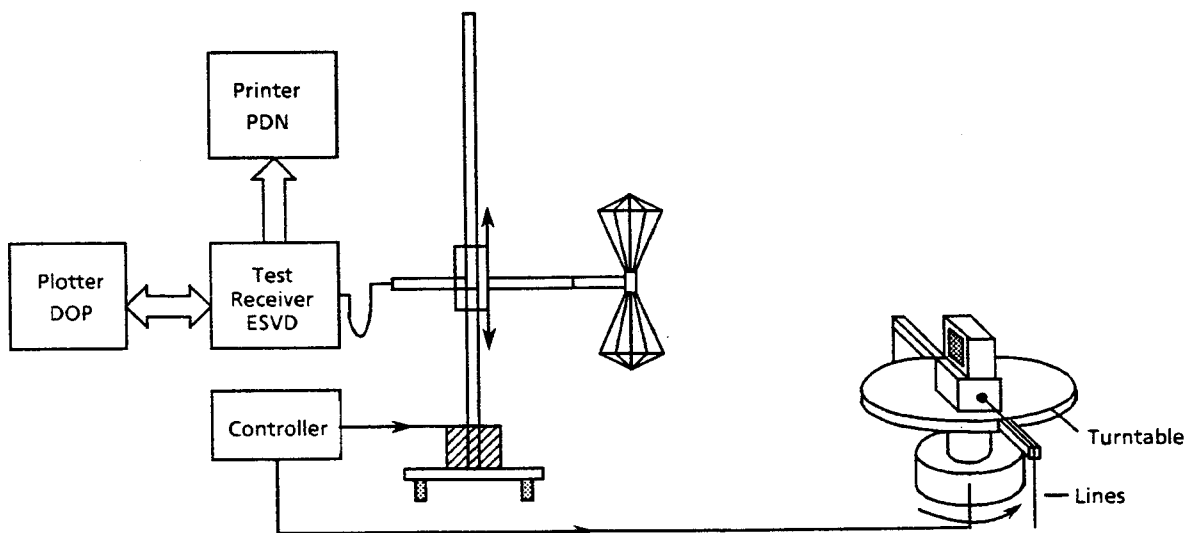

Fig. 3-52 Test setup for free-field RFI fieldstrength measurement

b) Setting of the Test Receiver

The scan setting of the test receiver determines the data of the prescan. For RFI fieldstrength measurements it covers a range from 30 to 1000 MHz.

Scan data:

Frequency range/MHz	30 - 1000
Stepsize/kHz	60 ¹⁾
Bandwidth (IF BW)/kHz	120
Detector	Pk
Meas. Time/s	02 ²⁾
Attenuation	Auto Low Noise
Operating Range/dB	60

- 1) With pure broadband interference, frequency-proportional step size (LOG step) can be used instead of steps half the bandwidth.
- 2) The measuring time per measured value is determined by the type of interference signal. It should be selected such that the highest value is recorded in the case of time-dependent variations. Minimum measuring times of 20 or 10 ms are therefore required for network-synchronous pulse interferences (50 Hz or 100 Hz).

The subsequent scan options are used for RFI fieldstrength measurements:

06 *E-Field ShR*

A pre-measurement of the fieldstrength spectrum is performed in a shielded room which is subsequently repeated semi-manually at a free-field test system.

- 30 Subrge/Margin is determined as explained in the introduction to this section.
Useful settings:

No of Subranges 25, 50 or 100

Acc. Margin/dB 6

- 40 The options 40 to 45 determine the type of detector for final measurement. Fieldstrength limit values generally apply for the QP detector. Option 42 Final QP is activated by the default setting of option 06.

Note: *Since the prescan is often performed in the near field of the device under test, the limit value curve may be set differently for the prescan and for the free-field measurement. A new determination of the limit value must then be carried out with the final measurement.*

c) Test Run, Measurement and Analysis Procedure

- ▶ The prescan is initiated by pressing the RUN/STOP key. It can be interrupted by pressing this key once and aborted by pressing the key twice (cf. section 3.2.4.3.4).

The following message is output at the ESVD:

```
DATA INPUT
OPT 06 E-FIELD SHR
>Prescan
Final Measmt
```

- ▶ Position the cursor at *Prescan*.
- ▶ Press one of the ENTER keys for starting the prescan. The ESVD subsequently reads out the message:

```
DATA INPUT
OPT 06 PRESCAN
Connect TRD: Antenna 1
>Continue
```

Name of the antenna 1), e.g. HK116

1) If the frequency range of only one antenna is scanned, the prescan is started immediately without this message being read out. Connection of all transducers is requested, ("Connect Antenna 1" and then "Connect Cable"), if the cable is used with the antennas.

- ▶ Press one of the ENTER keys
The prescan runs until the frequency is reached where antennas are switched over with determination of the subrange maxima (PK) and read-out of the message *SCAN Running....*

Note: The RFI fieldstrength spectrum can be recorded by a plotter connected using option 62.

A beep indicates when another antenna is to be connected and the following request is read out:

```
DATA INPUT
OPT 06 PRESCAN
Connect TRD: Antenna 2
>Continue
```

Name of the antenna, e.g. HL223

Press one of the ENTER keys. The prescan is continued until the end.

All subrange maxima are/will be stored in the CMOS-RAM. The list of the subrange maxima can be output as list of measured values, if required.

Measured value tables with RFI fieldstrength measurement (subsequent to the prescan):

Frequency MHz	Pk Level dB μ V/m	Pk Limit dB μ V/m
31.3000	41.4	45.1
37.4500	47.3*)	45.7
51.3500	44.5	46.5

*) limit exceeded

The list of frequencies can also be edited (same editor as for option 63) and thus modified. The min. and max. levels as well as the min. and max. frequencies of the prescan (default) are received, they can, however, be varied during the editing process. It is not suitable to enter the results of the final measurement into the graph of the pre-measurement, if both results have been acquired under different circumstances (different distances, resonances inside the shielded room) and different limit values apply. The new limit values can be activated before starting the Final Test.

The open air test system allows for performing the final measurement by starting the Final Test:

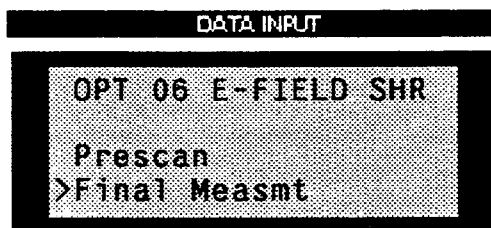

- ▶ Position the cursor at *Final Measmt*
- ▶ Press one of the ENTER keys.

Note: If the prescan is started by mistake, the stored measured values are lost.

If the frequencies stored require more than one antenna to be connected, this is indicated by a beep and the request:

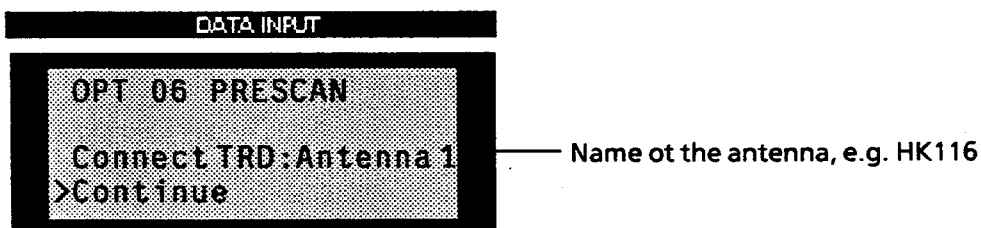

- ▶ Vary the frequency using the rotary knob to trace drifting interferences. The currently set frequency is entered into the list of measuring values. If the same frequency with the same detector (measuring bandwidth) is set twice during the searching procedure the frequency with the lower level is suppressed. Therefore, the list does not contain the same frequency twice.

Upon start of the measurement the ESVD sets the frequency of the subrange maximum and the QP detector (option 42).
The display reads out:

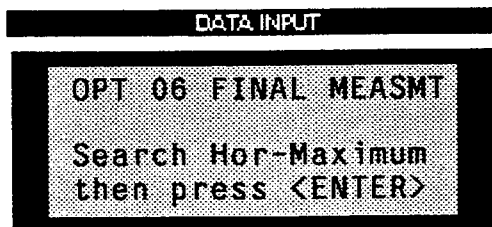

- ▶ With horizontal polarization, the height of the antenna and the azimuth of the turntable have to be varied until the max. ambient interference has been found.
- ▶ Press one of the ENTER keys.
The value indicated in the LEVEL display is stored.

Note: If the spurious emissions of the device under test cannot be measured due to ambient interference, another frequency can be set using the → key.

After storing the horizontal maximum the following request is output:

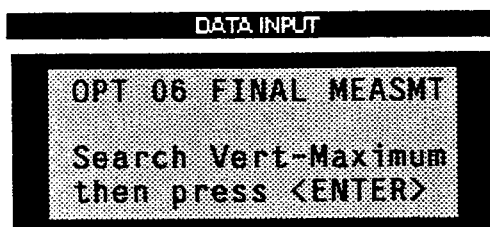

- ▶ With vertical polarization, the height of the antenna and the azimuth of the turntable have to be varied until the vertical maximum of the ambient interference has been found.
- ▶ Press one of the ENTER keys.
The value is indicated in the LEVEL display and output on the plotter as " + ". The ESVD then sets the next frequency, etc.

Returning to a previously set frequency is possible by pressing the ← key. The operator is thus enabled to repeat a measurement under different operating conditions of the device under test and can write a new value for a value stored inadvertently by pressing the ENTER key.

Tables of measured values with RFI fieldstrength measurement after performing the Final Test:

Frequency MHz	QP Level hor. dBµV/m	QP Level vert. dBµV/m	QP Limit dBµV/m
31.3000	41.4	39.1	45.5
37.4500	47.3*	43.3	45.7
51.3500	44.5	47.6*	46.5

* limit exceeded

3.5 Program Examples

The examples given in this section illustrate how to program the test receiver and may be the foundation for the solution of more complex spheres of measurement. The examples are based on each other step by step and each one is explained.

The programming language used is the Rohde & Schwarz-BASIC from version 2.00 onward. It is, however, possible to translate the programs into other languages

3.5.1 Initialization and Initial State

At the beginning of every program, the IEC bus and the settings of the receiver should be brought into a defined default status. It is helpful to use subprograms, in this case "Prolog" and "Init_esvd".

The controller terminator should be set to "linefeed" (decimal 10), which - together with EOI - is the only permissible terminator according to the standard IEEE 488.2 and is also made use of in the ESVD.

```
10000 '
10010Prolog:
10020 '
10030   IEC TERM 10: '           Linefeed
10040   IEC TIME 1000: '       Timeout 1s
10050 '
10060   Esvd=20: '             Receiver IEC address
10070 '
10080 '                         other initialization
10090 '
10100 RETURN
10110 '-----
```

The IEC bus status register and the device settings of the receiver are brought to their default status using a further subprogram:

```
11000 '
11010Init_esvd:
11020 '
11030 '                         reset status registers
11040   IEC OUT Esvd,"*CLS"
11050 '
11060 '                         reset Receiver settings
11070   IEC OUT Esvd,"*RST"
11080 '
11090 '                         init other devices
11100 '
11110 RETURN
11120 '-----
```

3.5.2 Sending a Device Setting Command

In this example some settings of the receiver section are made: frequency, RF attenuation and demodulator.

```
100 '-----
110 '      Send Receiver settings
120 '-----
130 '
140 GOSUB Prolog
150 GOSUB Init_esvd
160 '                                     send new settings
170 IEC OUT Esvd,"FREQUENCY 20 MHZ"
180 IEC OUT Esvd,"ATTENUATION 30 DB;DETECTOR PEAK"
190 '
200 END
210 '-----
10000 '
10010Prolog:
10020 '
10030   IEC TERM 10: '                   Linefeed
10040   IEC TIME 1000: '                 Timeout 1s
10050 '
10060   Esvd=20: '                       Receiver IEC address
10070 '
10080 '                                   other initialization
10090 '
10100 RETURN
10110 '-----
11000 '
11010Init_esvd:
11020 '
11030 '                                     reset status registers
11040   IEC OUT ESVD,"*CLS"
11050 '
11060 '                                     reset Receiver settings
11070   IEC OUT ESVD,"*RST"
11080 '
11090 '                                     init other devices
11100 '
11110 RETURN
11120 '-----
```

The subprograms "Prolog" and "Init_esvd" still integrated in this example will no longer be part of the following examples.

3.5.3 Reading of the Device Settings

The settings made in the preceding example are read in this program. The commands are used in short form for this purpose.

```
100 '-----
110 '   Read Receiver settings
120 '-----
130 '
140 GOSUB Prolog
150 '
160 '               read settings
170 IEC OUT Esvd,"FR?"
180 IEC IN Esvd,Frequency$
190 '
200 IEC OUT Esvd,"A?"
210 IEC IN Esvd,Rf_attenuation$
220 '
230 IEC OUT Esvd,"DET?"
240 IEC IN Esvd,Detector$
250 '               print settings on screen
260 PRINT Frequency$
270 PRINT Rf_attenuation$
280 PRINT Detector$
290 '
300 END
```

In line with the settings that have been made earlier, the following indication results:

```
FREQUENCY 20000000
ATTENUATION 30
DETECTOR PEAK
```

3.5.4 Triggering a Single Measurement and Synchronization using *WAI

In this case a level measurement at a frequency previously set is started using the common command *TRG. *WAI serves to delay the processing of further commands until all the previous commands - in this case the level measurement - are executed. Only then is the result of the last measurement read in and indicated on the screen. When using *WAI, please note that the set timeout must be longer than the processing time of the commands, as otherwise an error message results. In this example the timeout of 1 s set in the prolog is sufficient for the default measuring time of 100 ms.

```
100 '-----
110 '   Trigger and read result
120 '-----
130 '
140 GOSUB Prolog
150 GOSUB Init_esvd
160 '                               set frequency
170 IEC OUT Esvd,"FREQUENCY 98.5 MHz"
180 '                               Trigger and Wait
190 IEC OUT Esvd,"*TRG;*WAI"
200 '                               get result
210 IEC OUT Esvd,"LEVEL:LASTVALUE?"
220 IEC IN Esvd,Level$
230 '                               print result on screen
240 PRINT Level$
250 END
```

The output on the screen might be as follows:

LEVEL:LASTVALUE 23.87

To simplify this frequently used sequence, the ESVD offers the command LEVEL?, which synchronizes internally level measurement and retrieving of the measured value. It substitutes for the commands *TRG;*WAI;LEVEL:LASTVALUE?. The synchronization mechanism described above can also be applied to all other commands.

3.5.5 Service Request Routine

The smartest and most flexible way of synchronization of sequences is offered by the Service Request. It requires an interrupt routine being part of the program of the system controller. The routine can be serviced asynchronously to the usual program run, if a Service Request occurs.

In the case of this subprogram the device(s) having sent the Request can be identified by their status bytes when polling the devices that might have sent one. Subsequently the appropriate measures can be taken.

To activate the interrupt capability of the controller, the command

```
nnn ON SRQ GOSUB label
```

must be added to the main program.

Service Request Routine:

```
12000 '-----
12010 '   Service Request Routine
12020 '-----
12030 Srq_routine:
12040 '           Serial Poll
12050 '   IEC SPL Esvd,Sb%
12060 '           Check SRQ-Bit
12070 '   IF (Sb% AND 64) THEN
12080 '           SRQ-Flag TRUE
12090 '   Srq%=1
12100 '           e.g. check registers
12110 '   ELSE
12120 '           poll other devices
12130 '   ENDIF
12140 '           enable SRQ Interrupt and return
12150 '           in the same line to avoid nesting!
12160 '
12170 ON SRQ GOSUB Srq_routine: RETURN
```

This very simple Service Request routine can be extended for the respective applications. It includes the operation of other devices connected to the bus or the weighting of additional IEC bus register or error recoveries.

If a Service Request is to be generated at the end of processing of a command, the Event Status Enable register ESE and Service Request Enable register must be configured correspondingly.

The command *OPC sets the bit 0 in the Event Status register. Analog to this setting, the bit 0 in the Event Status Enable register must be set. Bit 5 in the Service Request Enable register must finally be set to enable a Service Request.

3.5.6 Synchronization with the End of the Scan using *OPC

In this example a scan, the end of which is waited for with the help of the command *OPC, is triggered. The end can be identified by the flag Srq% which is set in the Service Request routine. The registers stated in the before-mentioned example are previously configured.

```
100 '-----
110 '      Execute Scan
120 '-----
130 '
140 '   GOSUB Prolog
150 '   GOSUB Init_esvd
160 '
170 '   GOSUB Exec_scan
180 '
190 END
3000 '-----
3010 '      Execute Scan and wait for Operation Complete
3020 '-----
3030 Exec_scan:
3060 '                               Init SRQ-Routine
3070 '   ON SRQ1 GOSUB Srq_routine
3080 '                               Config Registers
3090 '   IEC OUT Esvd,"*CLS;*ESE 1;*SRE 32"
3100 '                               Init SRQ-Flag
3110 '   Srq%=0
3120 '                               Start Scan
3130 '   IEC OUT Esvd,"SCAN:RUN;*OPC"
3140 '
3150 '                               Do something useful
3160 '                               while scanning
3170 '
3180 '   REPEAT
3190 '                               Do something useful too
3200 '                               or just wait
3210 '   UNTIL Srq%
3220 '                               Scan is completed
3230 RETURN
3240 '-----
```

3.5.7 Programming a Scan Data Set

This example illustrates the definition of a scan data set for RF analysis consisting of two ranges. The appertaining receiver settings are also made and the level range shown in the diagram is set.

```
100 '-----
110 '      Set Scan Data
120 '-----
130 '
140   GOSUB Prolog
150   GOSUB Init_esvd
160 '
170   GOSUB Prog_scan
180 '
190 END
2000 '-----
2010 '      Define Settings for RF Analysis
2020 '-----
2030 Prog_scan:
2060 '
2070 '                      define grid
2080   IEC OUT Esvd,"GRID:FREQAXIS LOG"
2090   IEC OUT Esvd,"GRID:MINLEVEL -20 dB"
2100   IEC OUT Esvd,"GRID:MAXLEVEL 80 dB"
2110 '
2120 '                      2 scan ranges
2130   IEC OUT Esvd,"SCAN:RANGES 2"
2140 '
2150 '                      linear steps
2160   IEC OUT Esvd,"SCAN:FREQUENCY:STEPMODE LIN"
2170 '
2180 '                      define frequency ranges
2190   IEC OUT Esvd,"SCAN 1"
2200   IEC OUT Esvd,"SCAN:FREQUENCY:START 20 kHz"
2210   IEC OUT Esvd,"SCAN:FREQUENCY:STOP 100 kHz"
2220   IEC OUT Esvd,"SCAN:FREQUENCY:STEP SIZE 10 Hz"
2230 '
2240   IEC OUT Esvd,"SCAN 2"
2250   IEC OUT Esvd,"SCAN:FREQUENCY:STOP 500 MHz"
2260   IEC OUT Esvd,"SCAN:FREQUENCY:STEP SIZE 100 kHz"
2270 '                      store settings
2280   IEC OUT Esvd,"SCAN:SAVE"
2290 '
2300 '                      define receiver settings
2310   IEC OUT Esvd,"SCAN 1"
2320   IEC OUT Esvd,"SCAN:RECEIVER:DETECTOR PEAK"
2330   IEC OUT Esvd,"SCAN:RECEIVER:BANDWIDTH:IF 10 kHz"
2340   IEC OUT Esvd,"SCAN:RECEIVER:MEASUREMENT:TIME 100 ms"
2350   IEC OUT Esvd,"SCAN:RECEIVER:ATTENUATION:AUTO ON"
2360   IEC OUT Esvd,"SCAN:RECEIVER:ATTENUATION:MODE LOWNOISE"
2370   IEC OUT Esvd,"SCAN:RECEIVER:RANGE 60 dB"
2380   IEC OUT Esvd,"SCAN:RECEIVER:PREAMPLIFIER OFF"
2400 '
2410   IEC OUT Esvd,"SCAN 2"
2420   IEC OUT Esvd,"SCAN:RECEIVER:DETECTOR PEAK"
2430   IEC OUT Esvd,"SCAN:RECEIVER:BANDWIDTH:IF 120 kHz"
2440   IEC OUT Esvd,"SCAN:RECEIVER:MEASUREMENT:TIME 20 ms"
2450   IEC OUT Esvd,"SCAN:RECEIVER:ATTENUATION:AUTO ON"
2460   IEC OUT Esvd,"SCAN:RECEIVER:ATTENUATION:MODE LOWNOISE"
2470   IEC OUT Esvd,"SCAN:RECEIVER:RANGE 60 dB"
2480   IEC OUT Esvd,"SCAN:RECEIVER:PREAMPLIFIER OFF"
2500 '
2510 '
2520 RETURN
```

3.5.8 Programming a Transducer Factor

In this example a transducer factor for an antenna is stored as transducer factor No. 1. In addition the name and unit are defined.

```

100 '-----
110 '      Transducer Factor
120 '-----
130 '
140 '   GOSUB Prolog
150 '   GOSUB Init_esvd
160 '
170 '   GOSUB Prog_tfactor
180 '
190 END
1000 '-----
1010 '      Define Transducer Factor and activate
1020 '-----
1030 Prog_tfactor:
1040 '   GOSUB Prolog
1050 '   GOSUB Init_esvd
1060 '
1070 '                                     define values
1080 DIM Frequency(10)
1090 DIM Level(10)
1100 '
1110 Frequency(0)=20E6: Level(0)=15.7
1120 Frequency(1)=25E6: Level(1)=17.6
1130 Frequency(2)=30E6: Level(2)=13.6
1140 Frequency(3)=35E6: Level(3)=12.1
1150 Frequency(4)=40E6: Level(4)=12.2
1160 Frequency(5)=45E6: Level(5)=11.2
1170 Frequency(6)=50E6: Level(6)=10.3
1180 Frequency(7)=55E6: Level(7)=9.7
1190 Frequency(8)=60E6: Level(8)=8.2
1200 Frequency(9)=65E6: Level(9)=7.4
1210 '
1220 '
1230 '                                     select factor
1240 '   IEC OUT Esvd,"TRANSDUCER:FACTOR 1"
1250 '
1260 '                                     transducer name
1270 '   IEC OUT Esvd,"TRANSDUCER:FACTOR:TEXT 'antenna1'"
1280 '
1290 '                                     transducer unit
1300 '   IEC OUT Esvd,"TRANSDUCER:FACTOR:UNIT DBUV_M"
1310 '
1320 '                                     build command string
1330 '
1340 '   Transducer$="10": '                                     number of values
1350 '   FOR I=0 TO 9 STEP 1
1360 '     Transducer$=Transducer$+","+STR$(Frequency(I))+","+STR$(Level(I))
1370 '   NEXT I
1380 '
1390 '                                     transmit factor
1400 '   IEC OUT Esvd,"TRANSDUCER:FACTOR:DEFINE "+Transducer$
1410 '
1420 '                                     activate factor
1430 '   IEC OUT Esvd,"TRANSDUCER:FACTOR:SELECT 1"
1440 '
1450 RETURN
1460 '

```

3.5.9 Programming a Transducer Set

A transducer set consisting of two ranges is made up of previously defined transducer factors. The used transducer factors must be defined for the frequency range of the selected transducer set range.

In this example two factors respectively are put together to form a set range. Each range might for instance represent an antenna with a cable.

The start frequency of the second range is already determined by the stop frequency of the first range.

```
100 '-----
110 '   Transducer Set
120 '-----
130 '
140   GOSUB Prolog
150   GOSUB Init_esvd
160 '
170   GOSUB Prog_tset
180 '
190 END
1000 '-----
1010 '   Define Transducer Set and activate
1020 '-----
1030Prog_tset:
1040 '
1050 '           select set
1060   IEC OUT Esvd,"TRANSDUCER:SET 1"
1070 '
1080 '           transducer set name
1090   IEC OUT Esvd,"TRANSDUCER:SET:TEXT 'RFI test'"
1100 '
1110 '           transducer unit
1120   IEC OUT Esvd,"TRANSDUCER:SET:UNIT DBUV_M"
1130 '
1140 '           define ranges
1150   IEC OUT Esvd,"TRANSDUCER:SET:RANGES 2"
1160 '
1170 '           select transducer factor
1180 '           4 and 7 for range 1
1190   IEC OUT Esvd,"TRANSDUCER:SET:RANGES:NUMBER 1"
1200   IEC OUT Esvd,"TRANSDUCER:SET:RANGES:START 20 kHz"
1210   IEC OUT Esvd,"TRANSDUCER:SET:RANGES:STOP 150 kHz"
1220   IEC OUT Esvd,"TRANSDUCER:SET:RANGES:DEFINE 2,4,7"
1230 '
1240 '           select transducer factor
1250 '           5 and 9 for range 2
1260   IEC OUT Esvd,"TRANSDUCER:SET:RANGES:NUMBER 2"
1270   IEC OUT Esvd,"TRANSDUCER:SET:RANGES:STOP 500 MHz"
1280   IEC OUT Esvd,"TRANSDUCER:SET:RANGES:DEFINE 2,5,9"
1290 '
1300 '           save set
1310   IEC OUT Esvd,"TRANSDUCER:SET:SAVE"
1320 '           activate set
1330   IEC OUT Esvd,"TRANSDUCER:SET:SELECT 1"
1340 '
1350 RETURN
1360 '

```

3.5.10 Output of a Test Report on Plotter

To enable the receiver to output a test report on a plotter via IEC bus it must be the IEC bus controller. If output is started by a process controller, the Pass Control protocol is used for this purpose. This means that the receiver is transferred IEC bus control by the process controller. After completion of plotter output the controller function is returned by the ESVD.

The receiver must previously be told the address of the process controller using the Pass Control Back command "*PCB address".

While the ESVD has the controller function, the process controller is not disabled. Only IEC bus functions requiring bus control cannot be performed by the process controller.

It waits for return of the controller function by the receiver with the help of the command "Wait Take Control" - WTCT.

```

100 '-----
110 '      Plot Test Report
120 '-----
130 '
140 '   GOSUB Prolog
150 '   GOSUB Init_esvd
160 '
170 '   GOSUB Plot_report
180 '
190 END
1000 '-----
1010 '      Plot_report
1020 '-----
1030 Plot_report:
1120 '                                     Controller address
1130 '   Controller=30
1140 '
1150 '                                     configure for Pass Control Back
1160 '   IEC ADR Controller
1170 '   IEC OUT Esvd,"*PCB "+STR$(Controller)
1180 '
1190 '                                     configure Test Report
1200 '                                     diagram and heading
1210 '   IEC OUT Esvd,"PLOTTER:CONTENT:DEFAULT ON"
1220 '
1230 '                                     select pens
1240 '   IEC OUT Esvd,"PLOTTER:SETUP:PEN ON"
1250 '   IEC OUT Esvd,"PLOTTER:SETUP:PEN:GRID 2"
1260 '   IEC OUT Esvd,"PLOTTER:SETUP:PEN:LIMIT 3"
1270 '   IEC OUT Esvd,"PLOTTER:SETUP:PEN:CURVE1 4"
1280 '   IEC OUT Esvd,"PLOTTER:SETUP:PEN:CURVE2 5"
1290 '   IEC OUT Esvd,"PLOTTER:SETUP:PEN:TEXT 1"
1300 '   IEC OUT Esvd,"PLOTTER:SETUP:PEN:DATE 4"
1310 '
1320 '                                     special scaling off
1330 '   IEC OUT Esvd,"PLOTTER:SETUP:FORMAT OFF"
1340 '
1350 '                                     header
1360 '   IEC OUT Esvd,"REPORT:HEADER:COMPANY 'Rohde & Schwarz'"
1370 '   IEC OUT Esvd,"REPORT:HEADER:PROGRAM 'Conformance Test'"
1380 '   IEC OUT Esvd,"REPORT:HEADER:EUT 'Machine'"
1390 '   IEC OUT Esvd,"REPORT:HEADER:MANUFACTURER 'No Name'"
1400 '   IEC OUT Esvd,"REPORT:HEADER:CONDITION 'green'"
1410 '   IEC OUT Esvd,"REPORT:HEADER:OPERATOR 'M. Keller'"
1420 '   IEC OUT Esvd,"REPORT:HEADER:SPEC 'internal #23'"
1430 '   IEC OUT Esvd,"REPORT:HEADER:REMARK1 'comments'"
1440 '   IEC OUT Esvd,"REPORT:HEADER:REMARK2 '''

```

1450	'	
1460	'	
1470	'	initiate Plot
1480	'	pass control to Receiver
1490	'	
1500	'	wait for plot complete
1510	'	and pass control back
1520	'	
1530	'	
1540	'	RETURN
1550	'	

3.5.11 Block Output of Scan Results in ASCII Format

The following example illustrates transmission of measurement results in the form of blocks proceeding with the measurement while RF analysis is being performed. The number of block elements to be transmitted simultaneously is set to 20. For the data type to be output "COMBINED" is selected, i.e. each measured level value together with all the additional information are contained in the data block. "ASCII" has been selected for the output format, i.e. the data are transferred in a string that can be directly read, e.g. "SCAN:BLOCK 0002,35,20000000, 13.24,0,20100000,14.58,0". The first numeral indicates the number of subsequent block elements, the second contains information on the composition of the block elements and is referred to as template. All the following numerals contain the actual measurement results, in this example, frequency, level and validity byte.

This format is the most time-consuming type of output since the conversion of binary data into ASCII format requires a lot of computing.

The extended Event Status register ERD is used to indicate that a sufficient amount of new data have been collected. The status registers are set such that the setting of a bit in this register initiates a service request. The complete data are therefore evaluated in the appertaining service request routine.

Another bit of this register indicates that the last block has been transmitted and thus provides the signal for termination of the program. After having initiated the polling of a block using "SCAN:BLOCK?", processing and formatting of the data in the output buffer is started. To make the required time available, the IEC bus timeout is set to 32 s.

The subprograms Prolog, Init_esvd und Prog_scan are already contained in the preceding examples and not dealt with in the following.

```
100 '-----
110 '   Transfer of Block Data in ASCII format
120 '-----
130 '
140   GOSUB Prolog
150   GOSUB Init_Esvd
160 '
170 '                               Define settings for RF analysis
180   GOSUB Prog_scan
190 '
200   GOSUB Exec_scan
210 '
220 '
230 END
3000 '-----
3010 '   Execute Scan and wait for last block
3020 '-----
3030 Exec_scan:
3040 '                               setup block format
3050   IEC OUT Esvd,"SCAN:BLOCK:FORMAT  ASCII"
3060   IEC OUT Esvd,"SCAN:BLOCK:ELEMENT  COMBINED"
3070   IEC OUT Esvd,"SCAN:BLOCK:COUNT  20"
3080 '                               config registers
3090   IEC OUT Esvd,"*CLS;*ESE 1;*SRE 33"
3100 '                               enable all bits
3110   IEC OUT Esvd,"ERDE 65535"
3120 '                               init variable
3130   Erd=0
3140 '                               waste previous results
3150   IEC OUT Esvd,"SCAN:RESULTS:CLEAR"
3160 '                               Init SRQ-Routine
3170   ON SRQ1 GOSUB Srq_routine
3180 '
3190   IEC OUT Esvd,"SCAN:RUN;*OPC"
3200   PRINT "Scan is running"
3210 '-----
```

```

3220 '
3230 REPEAT
3240 '          Wait for last block
3250 '          of scan results
3260 UNTIL Erd AND 4
3270 '
3280 PRINT "Transfer completed"
3290 '
3300 RETURN
4000 '-----
4010 '          Get data block
4020 '-----
4030 Block_query:
4040 '          data query
4050 IEC OUT Esvd,"SCAN:BLOCK?"
4060 '
4070 '          wait for data processing
4080 IEC TIME 32000
4090 '          get data
4100 IEC IN Esvd,Block$
4110 '
4120 '          length of data block
4130 Count=LEN(Block$)
4140 '
4150 '
4160 RETURN
12000 '-----
12010 '          Service Request Routine
12020 '-----
12030 Srq_routine:
12040 '          Serial Poll
12050 IEC SPL Esvd,Sb%
12060 '          check SRQ bit
12070 IF (Sb% AND 64) THEN
12080 '----- check ERD bit
12090     IF (Sb% AND 1) THEN
12100 '          read ERD register
12110         IEC OUT Esvd,"ERD?"
12120         IEC IN Esvd,Erd$
12130         Erd=VAL(Erd$)
12140         PRINT "ERD:";Erd
12150 '----- check insufficient RAM bit
12160         IF (Erd AND 16) THEN
12170             PRINT "Insufficient RAM"
12180         ENDIF
12190 '----- check data ready bit
12200         IF (Erd AND 128) THEN
12210 '          read data block
12220             GOSUB Block_query
12230             Sum=Sum+(Count-1)
12240 '          print results
12250             PRINT Block$
12260             PRINT
12270             PRINT "-->";Sum;" bytes up to now"
12280         ENDIF
12290     ENDIF
12300 '----- check ESR Bit
12310     IF (Sb% AND 32) THEN
12320         PRINT "Operation complete"
12330 '          clear enable register
12340         IEC OUT Esvd,"*ESE 0"
12350     ENDIF
12360 ELSE
12370 '----- poll other devices
12380 ENDIF
12390 '          enable SRQ Interrupt and return
12400 '          in the same line to avoid nesting!
12410 '
12420 ON SRQ1 GOSUB Srq_routine: RETURN

```

3.5.12 Block Output of Scan Results in Binary Format

In this example the data are output in binary format. Evaluation is slightly more difficult since binary data are output without any significant separator. Furthermore some parts of a block element cannot be assigned to a fixed space in the data block as the results can be made up differently depending on the receiver setting.

The routine stated below starts with evaluating the first two bytes of the data block, which contain the number of block elements in the data string and subsequently the next two bytes, the contents of which indicates the composition of a block element.

The FOR - NEXT loop actually serving to split up the block elements can be designed so universally as to be valid for all sorts of block data using these two data. The variable Index% represents a pointer always pointing to the data to be analysed next in the result string. Depending on the data the pointer is switched further.

In an application program this mere procedure is sufficient to cover all cases.

Output of a header is switched off as it is not required and would render data analysis only more difficult.

A special feature is evaluation of the frequency. The receiver transmits the values for floating decimal point variables in IEEE format with double accuracy. R&S BASIC uses the same internal type of representation of floating-point numbers. Instead of complex conversion processes it is thus possible to copy the bytes directly from the result string into the internal variable memory of BASIC using the VARPTR and POKE commands.

This principle may also be used in other programming languages provided that it or a library that can be linked to the language support the IEEE double precision format.

```
100 '-----
110 '   Transfer of Block Data in binary format
120 '-----
130 '
140   GOSUB Prolog
150   GOSUB Init_Esvd
160 '
170 '                               Define settings for RF analysis
180   GOSUB Prog_scan
190 '
200   GOSUB Exec_scan
210 '
220 '
230 END
3000 '-----
3010 '   Execute Scan and wait for last block
3020 '-----
3030 Exec_scan:
3040 '                               setup block format
3050   IEC OUT Esvd,"SCAN:BLOCK:FORMAT  BINARY"
3060   IEC OUT Esvd,"SCAN:BLOCK:ELEMENT  COMBINED"
3070   IEC OUT Esvd,"SCAN:BLOCK:COUNT  20"
3080 '                               config registers
3090   IEC OUT Esvd,"*CLS;*ESE 1;*SRE 33"
3100 '                               enable all bits
3110   IEC OUT Esvd,"ERDE 65535"
3120 '                               init variable
3130   Erd=0
3140 '                               waste previous results
3150   IEC OUT Esvd,"SCAN:RESULTS:CLEAR"
3160 '                               suppress header
3170   IEC OUT Esvd,"HEADER OFF"
3180 '                               terminator EOI for binary data
3190   IEC TERM 1
```

```

3200 '                               Init SRQ-Routine
3210 ON SRQ1 GOSUB Srq_routine
3220 '
3230 IEC OUT Esvd,"SCAN:RUN;*OPC"
3240 PRINT "Scan is running"
3250 '
3260 '
3270 REPEAT
3280 '                               Wait for last block
3290 '                               of scan results
3300 UNTIL Erd AND 4
3310 '
3320 PRINT "Transfer completed"
3330 '
3340 RETURN
4000 '-----
4010 '                               Get data block
4020 '-----
4030 Block_query:
4040 '                               data query
4050 IEC OUT Esvd,"SCAN:BLOCK?"
4060 '
4070 '                               wait for data processing
4080 IEC TIME 32000
4090 '                               get data
4100 IEC IN Esvd,Block$
4110 '
4120 '                               length of data block
4130 Count=LEN(Block$)
4140 '
4150 '
4160 RETURN
5000 '-----
5010 '                               Extract results from binary data block
5020 '-----
5030 Block_analysis:
5040 '                               get count of block elements
5050 '
5060 Num_of_elts%=ASC(LEFT$(Dump$,1))+ASC(MID$(Dump$,2,1))*256
5070 PRINT Num_of_elts%;" block elements received"
5080 '
5090 '                               get template word
5100 '
5110 Template%=ASC(MID$(Dump$,3,1))+ASC(MID$(Dump$,4,1))*256
5120 PRINT "Template ";Template%
5130 '
5140 Index%=5: '                               pointer to block data
5150 '
5160 '-----                               single block elements
5170 FOR I=1 TO Num_of_elts%
5180 '                               8 byte frequency
5190 '-----                               IEEE format
5200 IF Template% AND 1 THEN
5210 Addr=VARPTR(Freq)
5220 FOR J=0 TO 7
5230 POKE Addr+J,ASC(MID$(Dump$,Index%+J,1))
5240 NEXT J
5250 PRINT Freq,
5260 Index%=Index%+8
5270 ENDIF
5280 '-----                               level, detector 1
5290 IF Template% AND 2 THEN
5300 Lev%=ASC(MID$(Dump$,Index%,1))+ASC(MID$(Dump$,Index%+1,1))*256
5310 Level1=Lev%/100
5320 PRINT Level1,
5330 Index%=Index%+2
5340 ENDIF
5350 '-----                               level, detector 2
5360 IF Template% AND 4 THEN

```

```

5370         Lev%=ASC(MID$(Dump$,Index%,1))+ASC(MID$(Dump$,Index%+1,1))*256
5380         Level2=Lev%/100
5390         PRINT Level2,
5400         Index%=Index%+2
5410     ENDIF
5420 '----- status word
5430         State%=ASC(MID$(Dump$,Index%,1))+ASC(MID$(Dump$,Index%+1,1))*256
5440         PRINT State%,
5450         Index%=Index%+2
5460 '----- transducer
5470         IF Template% AND 64 THEN
5480             Lev%=ASC(MID$(Dump$,Index%,1))+ASC(MID$(Dump$,Index%+1,1))*256
5490             Trd=Lev%/100
5500             PRINT Trd,
5510             Index%=Index%+2
5520         ENDIF
5530 '----- limit byte
5540         IF Template% AND 128 THEN
5550             Lim%=ASC(MID$(Dump$,Index%,1))+ASC(MID$(Dump$,Index%+1,1))*256
5560             PRINT Lim%,
5570             Index%=Index%+2
5580         ENDIF
5590 '----- limit 1
5600         IF Template% AND 256 THEN
5610             Lev%=ASC(MID$(Dump$,Index%,1))+ASC(MID$(Dump$,Index%+1,1))*256
5620             Limit1=Lev%/100
5630             PRINT Limit1,
5640             Index%=Index%+2
5650         ENDIF
5660 '----- limit 2
5670         IF Template% AND 512 THEN
5680             Lev%=ASC(MID$(Dump$,Index%,1))+ASC(MID$(Dump$,Index%+1,1))*256
5690             Limit2=Lev%/100
5700             PRINT Limit2,
5710             Index%=Index%+2
5720         ENDIF
5730         PRINT
5740     NEXT I
5750 RETURN
12000 '-----
12010 '     Service Request Routine
12020 '-----
12030Srq_routine:
12040 '     Serial Poll
12050 IEC SPL Esvd,Sb%
12060 '     check SRQ bit
12070 IF (Sb% AND 64) THEN
12080 '----- check ERD bit
12090     IF (Sb% AND 1) THEN
12100 '     read ERD register
12110         IEC OUT Esvd,"ERD?"
12120         IEC IN Esvd,Erd$
12130         Erd=VAL(Erd$)
12140         PRINT "ERD:";Erd
12150 '----- check insufficient RAM bit
12160         IF (Erd AND 16) THEN
12170             PRINT "Insufficient RAM"
12180         ENDIF
12190 '----- check data ready bit
12200         IF (Erd AND 128) THEN
12210 '     read data block
12220             GOSUB Block_query
12230             Sum=Sum+(Count-1)
12240 '     convert binary data
12250             GOSUB Block_analysis
12260 '
12270             PRINT "-->";Sum;" bytes up to now"
12280         ENDIF
12290     ENDIF

```

```
12300 '----- check ESR Bit
12310     IF (Sb% AND 32) THEN
12320         PRINT "Operation complete"
12330 '                                     clear enable register
12340         IEC OUT Esvd,"*ESE 0"
12350     ENDIF
12360 ELSE
12370 '----- poll other devices
12380 ENDIF
12390 '                                     enable SRQ Interrupt and return
12400 '                                     in the same line to avoid nesting!
12410 '
12420 ON SRQ1 GOSUB Srq_routine: RETURN
```

3.5.13 Block Output of Scan Results in Internal Data Format (Dump)

In this format evaluation of the results is most simple as the data are arranged one after the other in increasing frequency sequence.

The appertaining frequency can be computed from start frequency, stop frequency and step size by the user program, if required.

The service request routine has been designed such that it evaluates the Event Status register ERD and is thus able to respond to the type of result ready to be fetched - detector 1, detector 2 or the validity byte. This routine is also of universal use.

This format offers the highest speed on receiver side compared to the other two formats, since no formatting is required. As against the two other data formats described before, the date to be transmitted is selected directly before polling the data block. This is required in order to enable access to all three types of results during the running scan. The data block can be fetched immediately after the command "SCAN:BLOCK?".

```
100 '-----
110 '   Transfer of unformatted Block Data
120 '-----
130 '
140   GOSUB Prolog
150   GOSUB Init_Esvd
160 '
170 '                               Define settings for RF analysis
180   GOSUB Prog_scan
190 '
200   GOSUB Exec_scan
210 '
220 '
230 END
3000 '-----
3010 '   Execute Scan and wait for last block
3020 '-----
3030 Exec_scan:
3040 '                               setup block format
3050   IEC OUT Esvd,"SCAN:BLOCK:FORMAT DUMP"
3060   IEC OUT Esvd,"SCAN:BLOCK:COUNT 100"
3070 '                               config registers
3080   IEC OUT Esvd,"*CLS;*ESE 1;*SRE 33"
3090 '                               enable all bits
3100   IEC OUT Esvd,"ERDE 65535"
3110 '                               init variable
3120   Erd=0
3130 '                               waste previous results
3140   IEC OUT Esvd,"SCAN:RESULTS:CLEAR"
3150 '                               terminator EOI for binary data
3160   IEC TERM 1
3170 '                               Init SRQ-Routine
3180   ON SRQ1 GOSUB Srq_routine
3190 '
3200   IEC OUT Esvd,"SCAN:RUN;*OPC"
3210   PRINT "Scan is running"
3220 '
3230 '
3240   REPEAT
3250 '                               Wait for last block
3260 '                               of scan results
3270   UNTIL Erd AND 4
3280 '
3290   PRINT "Transfer completed"
3300 '
3310 RETURN
4000 '-----
```

```

4010 '          Get data block
4020 '-----
4030Block_query:
4040 '          data query
4050 IEC OUT Esvd,"SCAN:BLOCK?"
4060 '
4070 '          get data
4080 IEC IN Esvd,Block$
4090 '
4100 '          length of data block
4110 Count=LEN(Block$)
4120 '
4130 '
4140 RETURN
12000 '-----
12010 '    Service Request Routine
12020 '-----
12030Srq_routine:
12040 '          serial poll
12050 IEC SPL Esvd,Sb%
12060 '          check SRQ bit
12070 IF (Sb% AND 64) THEN
12080 '----- check ERD bit
12090 IF (Sb% AND 1) THEN
12100 '          read ERD register
12110 IEC OUT Esvd,"ERD?"
12120 IEC IN Esvd,Erd$
12130 Erd=VAL(Erd$)
12140 PRINT "ERD:";Erd
12150 '----- check insufficient RAM bit
12160 IF (Erd AND 16) THEN
12170 PRINT "Insufficient RAM"
12180 ENDIF
12190 '----- check data ready bit detector 1
12200 IF (Erd AND 128) THEN
12210 '          configure for detector 1
12220 IEC OUT Esvd,"SCAN:BLOCK:ELEMENT DET1"
12230 PRINT "Detecor 1: ";
12240 '          get data block
12250 GOSUB Block_query
12260 Sum=Sum+Count/2
12270 '          print level values
12280 FOR I=1 TO Count/2
12290 Lev%=ASC(MID$(Block$,I*2-1,1))+ASC(MID$(Block$,I*2,1))*256
12300 '          1/100 dB resolution; signed
12310 Level=Lev%/100
12320 PRINT USING "-###.## ";Level;" ";
12330 NEXT
12340 PRINT
12350 PRINT "-->";Sum;" values up to now"
12360 ENDIF
12370 '----- check data ready bit detector 2
12380 IF (Erd AND 64) THEN
12390 '          configure for detector 2
12400 IEC OUT Esvd,"SCAN:BLOCK:ELEMENT DET2"
12410 PRINT "Detecor 2: ";
12420 '          get data block
12430 GOSUB Block_query
12440 '          print level values
12450 FOR I=1 TO Count/2
12460 Lev%=ASC(MID$(Block$,I*2-1,1))+ASC(MID$(Block$,I*2,1))*256
12470 '          1/100 dB resolution; signed
12480 Level=Lev%/100
12490 PRINT USING "-###.## ";Level;" ";
12500 NEXT
12510 PRINT
12520 ENDIF
12530 '----- check data ready bit validity
12540 IF (Erd AND 32) THEN

```

```

12550 '                                configure for validity byte
12560 IEC OUT Esvd,"SCAN:BLOCK:ELEMENT VALID"
12570 PRINT "Validity: ";
12580 '                                get data block
12590 GOSUB Block_query
12600 '                                print validity bytes
12610 FOR I=1 TO Count
12620 PRINT USING "###";(ASC(MID$(Block$,I,1))); " ";
12630 NEXT
12640 PRINT
12650 ENDIF
12660 ENDIF
12670 '----- check ESR bit
12680 IF (Sb% AND 32) THEN
12690 PRINT "Operation complete"
12700 IEC OUT Esvd,"*ESE 0"
12710 ENDIF
12720 ELSE
12730 '----- poll other devices
12740 ENDIF
12750 '                                enable SRQ Interrupt and return
12760 '                                in the same line to avoid nesting!
12770 '
12780 ON SRQ1 GOSUB Srq_routine: RETURN

```



3.5.1 Programming example of a fast level measurement

In this example, programming was done in QuickBASIC. The program allows the recording of up to 1000 measured values with a trigger rate of 5000 Hz. If the measurement is to be made over a relatively long period, either a larger array in which the data are read (defined by the variable `bufsize%`) must be used or the resulting measured values must be continuously processed.

For translation of the program, use the QuickBASIC Compiler PS-K1 in conjunction with the IEC Bus Driver PS-K2.

```
*****
' This program is using a Test Receiver ESVS10, ESVD or ESVB to
' do FAST-LEVEL-Measurements.
' It can read up to 1000 results in an integer array.
' The first ten results are printed out on the screen.
' The measurement will be repeated until a key will be pressed!
' Timeout is default (10 seconds)
*****
'
' To use this program, the GPIB.COM device driver must be loaded into
' memory and must be configured for default (no changes made with IBCONF).
'
' The ESXS IEEE address should be set to 18.
*****
' M. Keller 1ES1                                06-OCT-92
'
' Copyright (c) 1992 Rohde & Schwarz Munich
*****
```

```
REM $INCLUDE: 'qbdec14.bas'
```

```
DECLARE SUB FINDERR ()
```

```
Lpctr = 0
```

```
bufsize% = 1000      ' count of meas values
DIM rd%(bufsize% * 2) ' result buffer, 2 bytes each result
```

```
CLS
```

```
' Assign a unique identifier to the Controller and store in
' variable CTRL%.
```

```
CICNAME$ = "GPIB0"
CTRL% = ILFIND(CICNAME$)
```

```
' Check for error on IBFIND call.
```

```
IF CTRL% < 0 THEN CALL FINDERR
```

```
' Set IEEE address of GPIB0 to address of CIC.
```

```
Controller% = &H1E      ' 30 decimal
IF ILPAD(CTRL%, Controller%) < 0 THEN FINDERR
```

```
' Assign a unique identifier to the ESXS ("Test Receiver") and store in
' variable ESXS%.
```

```
BDNAME$ = "DEV1"
ESXS% = ILFIND(BDNAME$)
```

```
' Check for error on IBFIND call.
IF ESXS% < 0 THEN CALL FINDERR
```

```
' Set IEEE address of DEV1 to address of ESXS (decimal 18).
```

```
V% = &H12
IF ILPAD(ESXS%, V%) < 0 THEN FINDERR
```

```

' Clear the device.
IF ILCLR(ESXS%) < 0 THEN FINDERR

' program receiver settings
WRT$ = "**PCB " + STR$(Controller%)
IF ILWRT(ESXS%, WRT$, LEN(WRT$)) < 0 THEN FINDERR

WRT$ = "ATTEN 0 DB;PREAMP ON;*WAI"
IF ILWRT(ESXS%, WRT$, LEN(WRT$)) < 0 THEN FINDERR

' insert additional receiver settings here!

DO ' begin loop

  Lpctr = Lpctr + 1
  PRINT "Loop # "; Lpctr

  ' Write the FAST LEVEL instruction to the ESXS.
  WRT$ = "SPECIALFUNC:FASTLEV"
  IF ILWRT(ESXS%, WRT$, LEN(WRT$)) < 0 THEN FINDERR

  ' Pass Control
  IF ILPCT(ESXS%) < 0 THEN FINDERR
  PRINT "Passed Control"

  ' Wait for My Listener Address
  IF ILWAIT(CTRL%, &H4) < 0 THEN FINDERR
  PRINT "Listener!"

  IF ILRDI(CTRL%, rd%(), (bufsize% * 2)) < 0 THEN
    PRINT "TIMEOUT!"
  END IF
  PRINT "received "; IBCNT%; " Bytes"

  ' print some results
  FOR i = 0 TO 9
    PRINT rd%(i) / 100,
  NEXT i

  ' initiate SRQ to stop Fast-level mode
  IF ILRSV(CTRL%, 65) < 0 THEN FINDERR
  PRINT : PRINT "RQS"

  ' wait for Bus control
  IF ILWAIT(CTRL%, &H20) < 0 THEN FINDERR
  PRINT "Received Control Back"

LOOP UNTIL INKEY$ <> "" ' end of loop

' To close out a programming sequence, call the IBCLR routine to clear device
' functions and call the IBONL function to disable the hardware and software.

CALL IBCLR(ESXS%)          ' clear the device
CALL IBLOC(ESXS%)         ' put device in local mode
CALL IBONL(ESXS%, (0))    ' disable hardware and software
END

SUB FINDERR STATIC
' A routine at this location would notify you that a IEEE call failed
PRINT "IEEE Error occured!"
STOP
END SUB

```

3.6 Hints, Error Messages and Warnings

Message	Cause	Section
<i>1. LO UHF unlock</i>	Hardware error synthesizer	4.2.3
<i>2. LO UHF unlock</i>	Hardware error synthesizer	4.2.3
<i>Bus control required</i>	Plotter output cannot be performed since receiver does not control IEC bus.	3.2.4.4.4
<i>CAL TOTAL required</i>	Total calibration must be performed.	3.2.3.12.1
<i>Connect Plotter!</i>	Plotter output was started without a plotter being connected or the plotter address is wrong.	3.2.4.4.4
<i>Connect Printer!</i>	Printer output was started without a printer being connected.	3.2.4.4.3
<i>Frequency Sequence</i>	Increasing frequency sequence concerning entries into the table has not been adhered to.	3.2.4.2.2 3.2.4.3.2 3.2.4.3.3
<i>FRN Osc unlock</i>	Hardware error synthesizer	4.2.3
<i>UHF Track Gen unlock</i>	Hardware error in synthesizer of tracking generator	4.2.3
<i>IEC Bus OFF (SF11)!</i>	Plotter output cannot be performed since the IEC bus is switched off. Switch it on using special function 11.	3.2.4.3.3
<i>Limit exceeded</i>	Measured value exceeds a limit line with Spec Func 16 ON.	3.2.3.13
<i>LO IF Analys unlock</i>	Hardware error in synthesizer of IF analysis	4.2.3
<i>Max 2 Limits</i>	Attempt to activate a third limit line was made.	3.2.4.3.2
<i>Max Freq 1000 MHz</i>	A frequency > 1000 MHz was entered (transducer factor, limit value).	3.2.4.2.2
<i>Max Freq 2050 MHz</i>		3.2.4.3.2
<i>Max Level 200 dB</i>	With the input of a transducer factor or a limit line a value > 200 dB was entered.	3.2.4.2.2 3.2.4.3.2
<i>Max xx values (xx = 10, 20 or 50)</i>	Maximum number of points for transducer factor or limit line is reached; no further point possible	3.2.4.2.2 3.2.4.3.2
<i>Meas invalid, Transd undefined</i>	An active transducer is not defined in the complete scan range. Invalid measured values out of the definition range.	3.2.4.3.4
<i>Min Freq 20 MHz</i>	With the input of a transducer or limit value a frequency below 20 MHz was entered.	3.2.4.2.2 3.2.4.3.2
<i>Min Level -200 dB</i>	With the input of a transducer factor or a limit line a value below - 200 dB was entered.	3.2.4.2.2 3.2.4.3.2
<i>RAM Batt low</i>	RAM battery flat, replacement is required as otherwise data are lost.	4.1.3
<i>Register empty</i>	A register containing no setting data was called using RCL.	3.2.4.5
<i>xx undef</i>	Attempt to activate a transducer or limit value not defined.	3.2.4.2.2 3.2.4.3.2
<i>ERR: +5V ERR: +10V ERR: +28V ERR: - 10V</i>	Hardware error during self-test.	4.2.4
<i>ERR:2nd Mixer</i>	Hardware error during self-test.	4.2.4



Message	Cause	Section
<i>ERR:30 dB Range</i> <i>ERR:60 dB Range</i>	Error during total calibration	3.2.3.12.3
<i>ERR:Detector Board</i>	Hardware error during self-test	4.2.4
<i>ERR:FRN Synthesizer</i>	Hardware error during self-test	4.2.4
<i>ERR:VHF Preselector</i>	Hardware error during self-test	4.2.4
<i>ERR:UHF Synthesizer</i>	Hardware error during self-test	4.2.4
<i>ERR:UHF Track Gen</i>	Hardware error during self-test	4.2.4
<i>ERR:Gain at 64 MHz</i>	Error during total calibration	3.2.3.12.3
<i>ERR:Gain at xx MHz</i>	Error during total calibration	3.2.3.12.3
<i>ERR:Gain at BW 10 kHz</i>	Error during total calibration	3.2.3.12.3
<i>ERR:IEC</i>	Hardware error during self-test	4.2.4
<i>ERR:IF Attenuator</i>	Error during total calibration	3.2.3.12.3
<i>ERR:IF Selection Board</i>	Hardware error during self-test	4.2.4
<i>ERR:Meas uncal</i>	Gain of the receiver cannot be set. The measured values are not accurate.	3.2.3.12.3
<i>ERR:Pk/MHz</i>	Error during total calibration	3.2.3.12.3
<i>ERR:QP</i>	Error during total calibration	3.2.3.12.3
<i>ERR:RS232</i>	Hardware error during self-test	4.2.4
<i>ERR:TimeClock</i>	Hardware error during self-test	4.2.4
<i>WARN:30 dB Range</i> <i>WARN:60 dB Range</i>	Warning during total calibration	3.2.3.12.3
<i>WARN:Curve OFF</i>	Hint in the case of plotter output during measurement (option 62) that the measurement curve is not plotted (Curve in Plotter Settings is OFF).	3.2.4.3.3
<i>WARN:Gain at 64 MHz</i>	Warning during total calibration	3.2.3.12.3
<i>WARN:Gain at xx MHz</i>	Warning during total calibration	3.2.3.12.3
<i>WARN:BW 10 kHz</i>	Warning during total calibration	3.2.3.12.3
<i>WARN:IF Attenuator</i>	Warning during total calibration	3.2.3.12.3
<i>WARN:No Pen selected</i>	No pen is selected during plotter output (Pen 0)	3.2.4.4.4
<i>WARN:Pk/MHz</i>	Warning during total calibration	3.2.3.12.3
<i>WARN:Plotter active</i>	During plotter output, output is restarted using "PLOT".	3.2.4.4.4
<i>WARN:QP</i>	Warning during total calibration	3.2.3.12.3



4 Maintenance and Troubleshooting

4.1 Maintenance

4.1.1 Mechanical Maintenance

The ESVD requires no mechanical maintenance at all. The front panel should be cleaned from time to time preferably using a soft, damp cloth.

4.1.2 Electrical Maintenance

4.1.2.1 Testing the Level Measuring Accuracy

As it is possible to perform a total calibration with the help of the built-in calibration generators, a high long-term stability of the level measurement characteristics, which exclusively depends on the aging of the calibration generators, is ensured. The measurement accuracy should be checked once every year according to section 5.2.6.1.1. The re-adjustments of the calibration generators required following exceedings of the tolerance limits should be effected by an R&S-service station.

4.1.2.2 Testing and Adjustment of the Frequency Accuracy

The frequency accuracy of the reference oscillator should be checked once a year according to section 5.2.1. Re-adjustment, if required, may be performed only after a running-in period of 30 days

- ▶ Remove the instrument cover (cf. section 4.3)
- ▶ Connect the frequency counter to the rear panel socket 32. The reference frequency of the counter must refer to a frequency standard with an error $< 1 \times 10^{-10}$, e.g. a caesium reference oscillator.
- ▶ Adjust the frequency accuracy to $10 \text{ MHz} \pm 1 \text{ Hz}$ using the potentiometer R1 (accessible via the bore in the cover of the oven-controlled crystal oscillator module, cf. fig. 4-1).

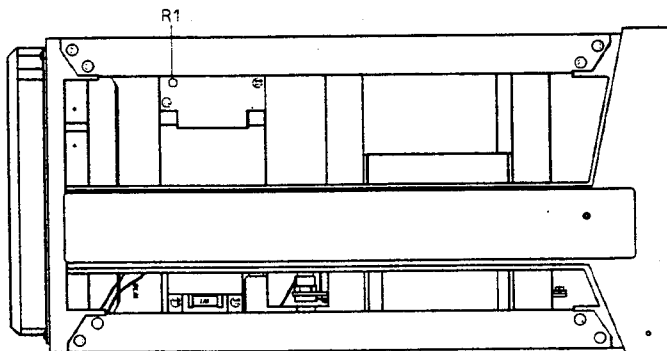

Fig. 4-1 Location of the potentiometer R1 (lateral view of instrument)

4.1.3 Replacing the Storage Battery

The instrument contains a lithium battery for buffering the static RAM. The durability at normal ambient temperatures (<30 °C) is about 5 years. The back-up battery is located on the A220 module (CPU BOARD). With the instrument switched on the battery voltage is constantly checked. A decreasing voltage causes the message *RAM Batt low* to be output on the screen following switch-on. To avoid the loss of all the internally stored data, such as instrument settings, limit lines or transducer factors, the storage battery can be replaced with the instrument switched on.

- ▶ Withdraw the instrument cover.
- ▶ Switch on the instrument.
- ▶ Unsolder the discharged battery.

The following types of batteries can be used instead:

- SAFT LS3 CNA (R&S order no. 565.1687)
- ELECTROCHE QTC85 1/2AA 3B960 (R&S order no. 565.1687)

When fitting the new battery by way of soldering, make sure that the polarity is correct (cf. fig. 4-2).

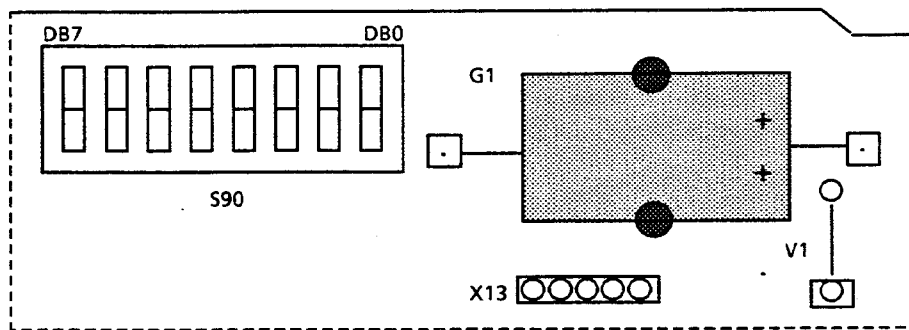

Fig. 4-2 Mounting position of the battery and DIP switch S90 for setting the receiver configuration (cf. Section 4.3.4).

4.2 Function Check and Self-Test

The ESVD features extensive equipment for checks and self-test, which allow comprehensive control of the receiver functions. If there is a fault, the device itself is able to locate the defect module. Exactly defined module interfaces make it possible to replace the modules without individual adjustment (cf. section 4.3). The adjustment to the total receiver, which may be required subsequently, is performed by menu-control and using the internal calibration generator so that no additional measuring instruments and devices are necessary.

The receiver functions are checked at four levels:

- Automatic test of the processor functions and adjustment of the A/D-converter following switch-on of the instrument.
- Test of all processor functions with cold start of the instrument.
- Permanent check of the synthesizers and power supply during operation.
- Function check of the total receiver (processor, synthesizer, signal unit) by manually calling the self-test.

4.2.1 Switch-on Test

When switching on the instrument the self-test of the processor functions first runs. Subsequently a rough function test of the CMOS RAM is subsequently performed by polling the contents of a memory location. The following initialization of the analog modules serves to check the correct functioning of the interface module for the serial module control. Function test and self-adjustment of the A/D-converter terminate the switch-on test of the ESVD.

4.2.2 Cold Start

An extended test of the CPU board is carried out with the so-called cold start of the receiver. It is triggered by pressing the "." key in the numeric keypad during switch-on of the ESVD.

Compared to the usual test (see above) the program memory (EPROM), the static (CMOS RAM) and the volatile data memory (DRAM), the IEC-bus as well as the interfaces of the remaining modules are tested additionally in the case of the cold start following switch-on. Upon the detection of an error the message *ERR: CPU* is output on the frequency display. The receiver can no longer be operated.

Since not every device function makes use of all function units of the processor module, it may be possible that the receiver can be further operated. In this case a detailed hint as to the defect function unit can be obtained by calling the self-test after having switched off and on again the ESVD.

Caution: *With the cold start all the data stored internally, such as limit lines and transducer factors are deleted and all the settings are brought to their default status.*

4.2.3 Checking the Synthesizer and the Power Supply

During operation all synthesizer loops in the instrument are checked as to whether the tuning voltages of the oscillators are within the permissible range. The following error messages may occur:

- *FRN Osc unlock*
- *1. LO UHF unlock*
- *2. LO UHF unlock*
- *320 MHz LO unlock* (only with option ESVD-B2 fitted; the ESVD can still be operated in the frequency range < 1 GHz).
- *149.4 M LO unlock* (with option ESVD-B1 fitted; the message indicates a fault in the I/Q outputs. All the measurement functions can still be used).

A hint as to the faulty module can be obtained by calling the self-test. If the level applied to the socket EXT REF INPUT is too small, the message *WARN:EXT REF LEV* is read out on the DATA INPUT display.

If the reference signal has a frequency that is not suitable for the ESVD, the message *WARN:EXT REF FREQ* is indicated on the DATA INPUT display.

The internal supply voltages are checked both following switch-on of the instrument and permanently during the operation independently of the controller. The flashing of the green LED SUPPLY OK on the rear panel signals the correct functioning of the power supply. The instrument is switched off within 3 s when a supply voltage deviates from its nominal value as well as when there is a short-circuit in the instrument or in one of the accessories supplied by the ESVD. In connection with a short-circuit current limiting device operating without delay, grave sequence errors are prevented. Due to the processor-independent operation this protective functions are still effective even when the CPU-board fails.

4.2.4 Self-Test

The self-test allows to check the functions of the instrument without using additional measuring instruments (cf. section 3.2.4.2.3). If there is an error in the instrument, the module causing the error is indicated in the DATA INPUT display. The error is located by means of the following measures:

- The A/D-converter on the processor module has an additional test input in order to measure voltages within the modules.
- During the self-test the important d.c. voltages, such as module-internal supply voltages or amplifier operating points, are measured and compared to their nominal values on every module.
- Level detectors check the oscillator levels required for operation of the mixer.
- The calibration generators produce a signal with an exactly known level at the RF input of the instrument. The processing of the input signal in the individual RF and IF stages of the receiver can be followed and faulty stages, e.g. amplifiers the gain of which deviates from the nominal value can be detected with the help of level detectors in the signal path. The detectors are available on every RF and IF module.

To avoid error messages that are not true, it must be checked whether all the functions of a lower function level operate correctly prior to checking a higher function level. It is thus only possible to recognize one error. The sequence in which the tests are performed results from the hierarchy of the functions in the instrument.

Operation:

- ▶ Press SELFTEST key.
The self-test menu is read out on the DATA INPUT display. The cursor is on the 1st menu item *01 Start Test*.
- ▶ Start the self-test for the complete instrument by pressing one of the two ENTER keys.
The hint *SELFTEST RUNNING* is displayed.

a) Testing the Processor Function

After having started the self-test or a cold start (cf. section 4.2.2) the processor functions and the internal supply voltages are first checked. If there is an error in one of the following function blocks on the CPU-board:

- MAIN CPU (processor),
- OT PROM (memory for operating system),
- FLASH EPROM (firmware program memory),
- IFPAS CONTROLLER (serial interface for control of the modules) or
- CMOS RAM (non-volatile data memory),

the instrument may not be able to output a detailed error message; the first and the third line of the DATA INPUT display appear in inverse screen: the instrument can no longer be operated.

An error occurring in one of the function blocks

- DRAM (volatile data memory),
- MUART (multi-function component),
- INTERRUPT CONTROLLER or
- A/D-converter

leads to the output of the message *ERR: CPU BOARD*; in addition the instrument can no longer be operated in order to prevent faulty measurements.

A faulty function in one of the blocks

- REAL TIME CLOCK (clock component),
- IEC BUS CONTROLLER (IEC-BUS interface),
- RS232 CONTROLLER (serial interface for loading a new firmware)

is indicated by the error messages

- *ERROR:Time Clock*,
- *ERROR:IEC* or
- *ERROR:RS232* during the self-test.

The error message remains visible until it is deleted by calling a menu. Since not every instrument function makes use of all function units, operation with reduced characteristics may be possible. To give a hint as to the defect module the message *ERR:CPU BOARD* appears. If there is no error, it is indicated by *CPU BOARD ok*.

b) Supply Voltage Test

First the device-internal supply voltages + 5 V, + 10 V, -10 V and + 28 V are checked. The message *ERR: Power Supply* is output on the DATA INPUT display in order to indicate that one or several supply voltages depart from the permissible range.

The self-test is aborted and the message "*Test aborted*" appears.

c) Synthesizer Test

Correct operation of all oscillators is required for testing the signal path. For this reason all the synthesizer modules are checked. As can be seen in figure 4-3, the ESVD contains two synthesizer modules. The reference oscillator and the function units REFERENCE LOOP and FRN LOOP are located on the module A160 (FRN SYNTHESIZER).

The module A120 (UHF SYNTHESIZER) contains the VCO for controlling the first mixer, the step recovery diodes multiplier circuit, sampling mixer as well as both a digital and analog control loop.

The module tests comprise the test of the control loops at various synthesizer divider factors, checking the operating points of oscillator and amplifier as well as the internal signal levels. An error contained in one of the two modules is indicated by *ERR:FRN Synth* or *ERR:UHF Synth*; the self-test is aborted and the hint "*Test aborted*" appears.

Subsequently the second conversion oscillator, which is contained on the module A 130 (2ND MIXER), and the associated control loop are checked. The message *ERR:2nd Mixer, Test aborted* is indicated on the DATA INPUT display, when there are deviations from the nominal frequency or when the oscillator level falls below that required for operation of the 2nd mixer

Provided that the ESVD is fitted with the options ESVD-B1 and ESVD-B2, the 320-MHz conversion oscillator and the 320-MHz phase locked loop are subsequently tested. A frequency or level error of the oscillator signal is indicated by "*ERR: I/Q Demodulator*". The same message is displayed in the case of a fault in the 149.4-MHz oscillator on the I/Q demodulator module.

After the successful completion of all synthesizer tests, "*Synth Boards ok*" appears on the DATA INPUT display.

d) Testing the Signal Path

Subsequently all the RF , IF and weighting modules contained in the receiver are checked. Figure 4-3 provides an overview on the signal flow:

Two calibration generators providing the test signals for checking the signal-processing stages are located on the module A130 (2ND MIXER). As correct operation of the calibration generators is a prerequisite for testing the signal path the output level and level control of the 64-MHz generator are first checked. A fault leads to the message *"ERR:2nd Mixer", "Test aborted"*. The signal flow via the attenuator, preselection filters, preamplifier, 1st mixer and 1st 1354.7-MHz IF amplifier is checked by means of a level detector; furthermore module-internal supply voltages, the operating points of the preamplifier and of the 1st IF amplifier and the tuning voltage of the variable preselection filters are checked. Any errors detected are read out on the DATA INPUT display by the messages *"ERR: ATTENUATOR"* or *"ERR.VHF Preselector", "Test aborted"*.

To begin with, the d.c. operating points of the 2nd 1354.7-MHz IF amplifier and of the 74.7-MHz IF amplifier are checked on the module A130 (2ND MIXER); the control loop and the output level of the 2nd conversion oscillator (2nd LO LOOP) are subsequently tested. Then the output level of the LO amplifier for control of the 3rd mixer is checked. In the case of an error the message *"ERR:"2nd Mixer", "Test aborted"* is output.

The self-test of the module A170 (IF SELECTION BOARD) starts with the examination of the operating points of the 10.7-MHz IF amplifier. The signal level applied to the module input is scanned by a level detector. The signal flow via the IF amplifiers and main selection filters is tested by measuring the d.c. levels applied to the demodulator output. In addition the IF gain correction that can be set digitally is tested. In the case of an error the message *"ERR:IF Select Board", "Test aborted"* is indicated on the DATA INPUT display.

The module A180 (DETECTOR BOARD) is subsequently tested. After having tested the module-internal supply voltages a level detector checks the 10.7-MHz input level of the listener path. The average value (AV) detector, peak value detector (PK) and the quasipeak detector (QP) are subsequently examined. After that the logarithmic amplifier is tested. Finally the control circuit for the analog instrument and the transducer correction are tested. If there is a faulty function, the message *"ERR:Detector Board", "Test aborted"* is indicated on the DATA INPUT display.

e) Testing the Options

UHF Preselector (ESVD-B2 Option)

The $n \times 100$ -kHz pulse generator integrated on the module A130 (2ND MIXER) serves both to calibrate the frequency response and to test the signal-processing stages of the UHF preselector. A level detector at the output of the IF amplifier checks the signal flow via the 4 fixed-tuned preselection filters with integrated GaAs-Fet amplifiers, the 1st mixer and the 1st 394.7-MHz IF amplifier. Furthermore the module-internal supply voltages, the operating points of the preamplifiers and of the IF amplifier and the switching currents of the PIN diode switches for change-over of the preselection filters are checked. Any defect causes the message "*ERR:UHF Preselector*" to be output on the DATA INPUT display. The self-test is not aborted in this case, since the ESVD can be operated properly in the frequency range of 20 to 1000 MHz.

I/Q Demodulator (ESVD-B1 Option)

The A300 module (I/Q demodulator) contains in its IF section the 2nd mixer, the 320-MHz conversion oscillator and the appertaining control loop as well as the 1st 74.7-MHz IF amplifier. The self-test includes checking the switchable supply voltages, the control loop and the IF amplifier. In the demodulator section, on the other hand, the control loop and the 149.4-MHz oscillator, the quadrature demodulator and the I- and Q output levels are tested. The message "*ERR: I/Q Demodulator*" is read out on the DATA INPUT display upon detection of an error.

f) Testing the measurement characteristics

After having completed the module test, a total calibration of the instrument is performed to check the measurement characteristics. If any tolerance is exceeded, a hint as to the faulty module results. Termination of the self-test is indicated by the message "*SELFTEST COMPLETE*". Proper functioning of the complete instrument is additionally acknowledged by the message "*Instrument o. k.*". The ESVD then returns to its normal operating mode. The entire self-test completed with "*Instrument ok*" takes about 120 seconds.

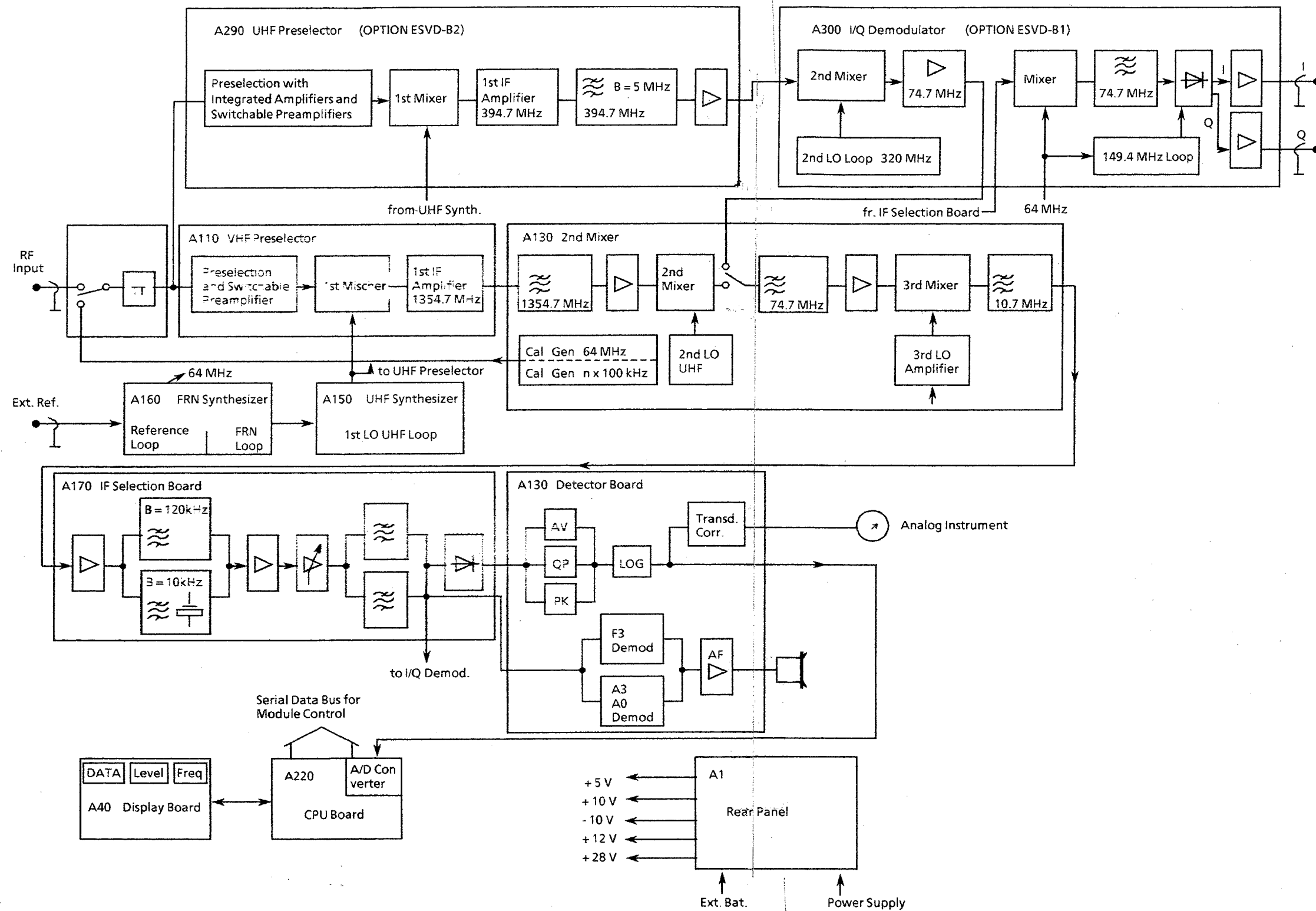

Fig. 4-3 Block diagram ESVD with I/Q Demodulator (option ESVD-B1) and UHF Preselector (option ESVD-B2)



4.3 Replacing the Modules

4.3.1 Opening the Instrument

- ▶ Switch off the instrument and remove the power plug.
- ▶ Unscrew the 4 Philips screws in the two rear panel feet and withdraw them to the rear.
- ▶ Withdraw the upper and lower instrument covers to the rear.

4.3.2 Removing a Module from the Instrument

- ▶ Put the instrument on its top side.

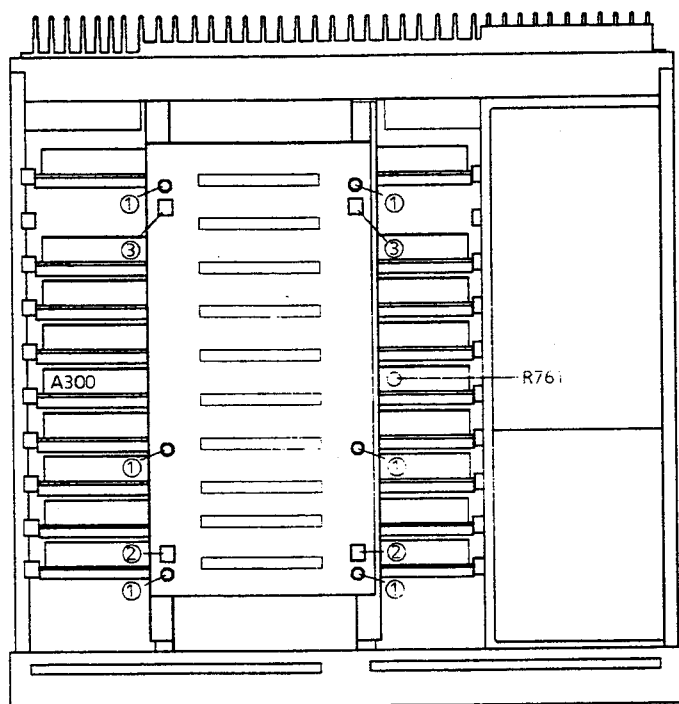

Fig. 4-4 Opened instrument seen from below

- ▶ Unscrew 6 Philips screws ① (*do not remove!*)
- ▶ Push the two locking rails ② toward the front panel using a slotted screwdriver (cf. hints "BOARDS UNLOCK").
- ▶ Removing the CPU-BOARDS:
 - ▶ Remove two ribbon cables at the bottom side of the module.
- ▶ Removing the remaining modules:
 - ▶ Remove the SMB-RF connector from the module to be replaced. In the case of the VHF preselector and UHF preselector modules also withdraw the SMA-RF connectors.
- ▶ Withdraw the respective module to the top by pushing it out of the instrument without effort.

4.3.3 Fitting a Module

- ▶ Slide the module into the instrument from above without effort. Take care that the cables will not be squeezed. The upper side of each module (identifiable by the cover with service labelling) must point to the rear panel.
- ▶ Plug the SMA/SMB-RF connector or ribbon cable again onto its place in line with the labelling. With correctly connected RF cabling, the cables may not cross each other.
- ▶ Slide without effort the module locking rails ③ toward the rear panel using a slotted screwdriver (cf. notes "BOARDS LOCK"). If the locking rails cannot be slid easily, the module has been incorrectly inserted
- ▶ Tighten the 6 Philips screws ①.

4.3.4 Taking the Receiver into Operation after the Replacement of a Module

- ▶ After replacement of the CPU BOARD module set the DIP switch using any item with a pointed tip as follows:

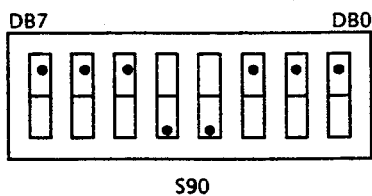

- ≙ switch pressed

Fig. 4-5 DIP switch

- ▶ Switch on the receiver.
- ▶ If required, install a new instrument firmware using an AT (cf. Section 4.4).
■ **Caution! Mind the safety regulations when using the instrument without cover!** ■
- ▶ Press the SELFTEST key.
The self-test menu is called.
Note: *Following the replacement of the modules UHF SYNTHESIZER, FRN SYNTHESIZER and CPU BOARD no adjustment is required.*
- ▶ Replacement of the modules VHF Preselector, 2nd Mixer or IF Selection Board:
 - ▶ Set an arbitrary frequency below 1000 MHz.
 - ▶ Call the *IF Gain Adj* function in the self-test menu and switch it on by pressing one of the two ENTER keys.
When the LEVEL display indicates a value in the range of 89.0 to 91.0 dB μ V, no re-adjustment is necessary.
 - ▶ An indication outside this range requires the level indication to be set to 90 dB μ V \pm 0.2 dB by turning the potentiometer IF GAIN ADJ R300 (cf. fig. 4-6). Then readjust R701 on the I/Q Demodulator module, if required.

- ▶ After replacement of the modules UHF Preselector, I/Q Demodulator or following the setting of the IF Gain Adj. potentiometer (R300):
 - ▶ Set an arbitrary frequency above 1000 MHz.
 - ▶ Call the *IF Gain Adj* function in the self-test menu and switch it on by pressing one of the two ENTER keys. The level indication is to be set to $30 \text{ dB}\mu\text{V} \pm 0.2 \text{ dB}$ by turning the potentiometer R761 at the bottom of the I/Q demodulator module (cf. fig. 4-4).

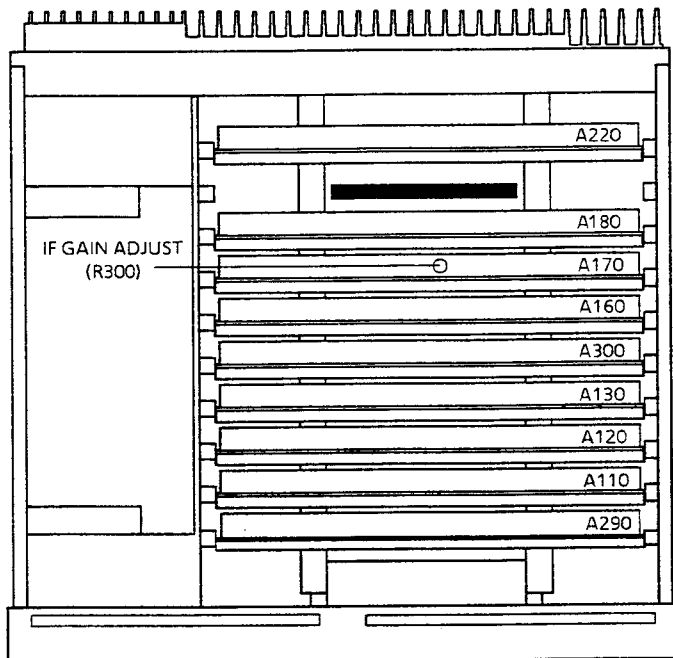

Fig. 4-6 Position of the potentiometer IF GAIN ADJUST, R300 (instrument seen from above)

- ▶ Start self-test.
When all the modules operate correctly and the RF cabling has been connected rightly, the message *Instrument ok* appears on the DATA INPUT display after completion of the self-test.
- ▶ Only when replacing the module DETECTOR BOARD:
 - ▶ Call the *Meter Adj* function in the self-test menu and switch it on by pressing one of the two ENTER keys.

- ▶ Turn the potentiometer "METER FULL SCALE" R654 ② (fig. 4-7) such that meter indication is identical with the 50-dB marker.

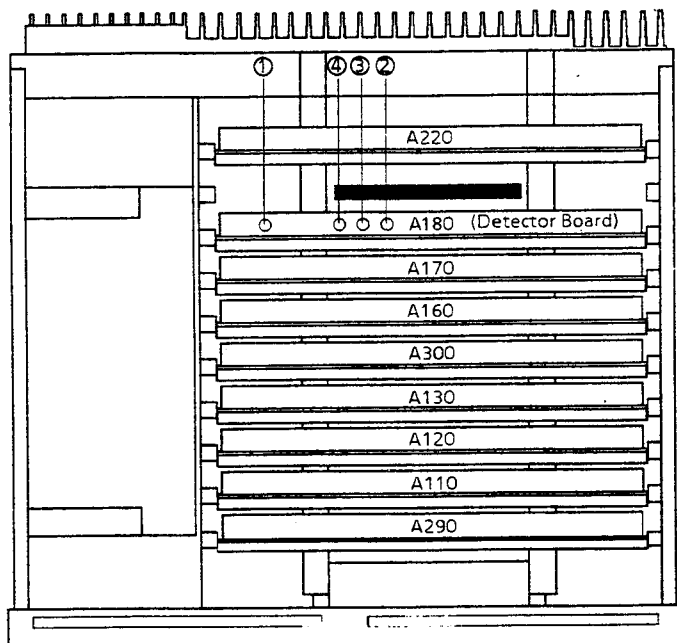

Fig. 4-7 Position of the adjustment points for the module DETECTOR BOARD

- ▶ Set the RF attenuation to 80 dB
- ▶ Set the pointer to 0 dB using the potentiometer "METER ZERO 60 dB" (R 631) ③.
- ▶ Set the OP RANGE to 30 dB.
- ▶ Set the pointer to 0 dB using the potentiometer "METER ZERO 30 dB" (R 630) ④.
- ▶ Set the RF attenuation to 50 dB.
- ▶ Call the function *CAL GEN ON/OFF* in the self-test menu.
- ▶ Activate and deactivate the calibration generator by pressing repeatedly the ENTER key while turning the potentiometer METER SPEED (R 652) ① such that the pointer of the moving-coil instrument overshoots by one pointer width when the calibration generator is switched on.
- ▶ Reselect the *Meter Adj* function and switch it off by pressing one of the two ENTER keys.

4.4 Hints for Loading the Instrument Firmware

4.4.1 Introduction

The instrument firmware for test receivers ESHS, ESVS and ESVD is stored in non-volatile FLASH memories, which can be erased and reprogrammed inside the instrument. To carry out a firmware update, it is thus no longer necessary to open the instrument in order to exchange the components. Loading is effected by means of the "FLASHUP.EXE" program from a personal computer (AT) via the serial RS232 interface.

4.4.2 Hardware Requirements

Firmware loading program FLASHUP.EXE can be executed on any personal computer conforming to industrial standard. The hardware must comprise a floppy disk drive (3 1/2" or 5 1/4") as well as an RS232 interface. The use of a hard disk is recommended. No demands are made on the screen.

Each serial standard interface cable comprising a 25-pin male and a 9-pin female connector can be used to connect the test receiver to the PC, a complete wiring (cf. Fig. 4-10) being mandatory. Rohde & Schwarz offer a corresponding cable under order no. 816.1096.00 (included in service kit EZ-8)

4.4.3 Files for FLASHUP

The program package for transferring the firmware consists of the following files:

<i>FLASHUP.EXE</i>	main program
<i>FLASHUPD.MSG</i>	help texts (German)
<i>FLASHUPD.NDX</i>	index for German help texts
<i>FLASHUPE.MSG</i>	help texts (English)
<i>FLASHUPE.NDX</i>	index for English help texts

There are separate files for the different test receiver series ESXS10, ESXS30 and ESS in which the instrument firmware to be loaded is stored:

<i>ESXS10.Hxx</i>	for test receivers ESHS10 / ESVS10 / ESVD
<i>ESXS30.Hxx</i>	for ESHS / ESVS models 20 and 30
<i>ESS.Hxx</i>	for ESS

"xx" denotes a 2-digit number which is different for each firmware version.

A disk contains one of those files together with the FLASHUP program package and the release notes in which the changes and extensions of the respective firmware version are listed in brief.

4.4.4 Installation

a) Loading from the Floppy Disk Drive

- ▶ Insert floppy disk into drive A: or B: and call the program:

```
C:\>a:flashup
```

b) Loading from the Hard Disk

- ▶ Copy firmware loading program FLASHUP.EXE to a hard disk:
Making a separate subdirectory is recommended.
- ▶ Insert the floppy disk containing the FLASHUP.EXE file or B: and start copying.

```
Example: C:\>md flash  
C:\>cd flash  
C:\FLASH>copy a:*. * c:
```

A higher processing rate is achieved additionally if the firmware to be loaded (i.e. the ESXS10.Hxx or ESXS30.Hxx file) is also copied to the hard disk.

4.4.5 Starting the Firmware Loading Procedure

Using this alternative, the execution time for the loading procedure of the instrument firmware can be shortened substantially. First the complete contents of the floppy disk has to be copied to the hard disk. Making a separate subdirectory on the hard disk is recommended

- ▶ Connect the PC to the test receiver by means of a cable.
- ▶ Switch off test receiver.
- ▶ Call *FLASHUP* program.
- ▶ Move the cursor between the different menu items by means of ← or → keys.
- ▶ Press ENTER key.
A pull down window is displayed.
- ▶ Select the menu items using ↑ or ↓ keys.
- ▶ Press ENTER key.
The function selected is executed or a parameter set.

The menu bar is reached or a current process aborted using the ESC key.

Help texts: A brief explanation about the contents of each function is given in the bottom line of the screen. Detailed help texts are available using the function key [F1]. The window opened can be closed again using the ESC key.

Error messages: The FLASHUP program supervises the firmware loading process which is protected by a defined protocol and by a check sum procedure. Whenever an error occurs during the transfer, the user is informed about the problem in a special window. As far as possible, the program gives hints on how to solve the problem.

Initialization:

- ▶ Select the firmware file to be loaded using menu item *File Select HEX-File*.
- ▶ Press ENTER.
The name of the file which was loaded last (if there is any) is displayed. If no file has been loaded, a selection list can be set up by simultaneously pressing the CTRL (or Strg) and ENTER keys. The drive can be changed by pressing the [F3] function key. This is necessary if the firmware is to be loaded from the floppy disk.
- ▶ Select the file using the cursor keys and confirm using ENTER.
- ▶ Select the serial interface at the PC to which the cable is connected (COM1 to COM4) and set the baud rate. The other RS232 parameters (word length, start/stop bit, etc.) are fixedly set.

The language for outputting help texts and error messages can be chosen between German and English.

The extensions and changes the firmware version contains are displayed under menu item *Info - Release Notes* (German or English).

Note: *All program parameters (set baud rate, HEX-file loaded, etc.) are saved in the FLASHUP.INI file and stored anew when exiting the program using QUIT.*

- ▶ Starting the loading procedure:
 - ▶ Select menu item *Execute* using the cursor keys.
 - ▶ The firmware loading procedure is started by pressing the ENTER key twice.
- ▶ Switch on test receiver.
The loading procedure runs automatically, the run is displayed by a bar display on the PC screen. The program signals the end of the transfer, the receiver automatically starts in its normal operating mode. The loading procedure can be aborted using the ESC key.

Note: *When aborting the loading procedure, the test receiver has no valid firmware. Thus it is inoperative. In order to load the firmware anew, menu item *Execute* has to be selected and the receiver to be switched off and on again.*

Exiting the program:

Exit firmware loading program FLASHUP by selecting menu item *QUIT* and pressing the ENTER keys.

25-pin D-shell (male)
(Test Receiver)

25pin D-shell (male)
(PC)

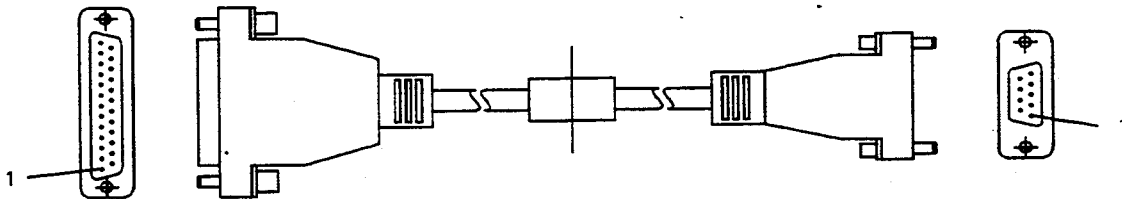
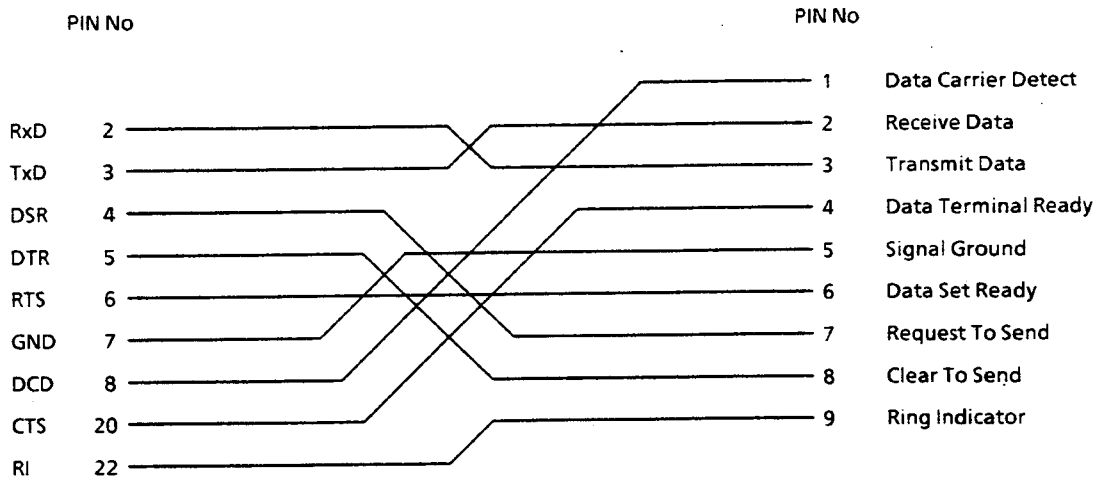

Fig. 4-8 Adapter cable for serial interface

5 Testing the Rated Specifications

5.1 Measuring Equipment and Accessories

Item	Type of Instrument	Required Characteristics	Suitable R&S-instrument	Order No.	Application
1	Frequency counter	up to 100 MHz error $< 1 \cdot 10^{-8}$ resolution 0.1 Hz			5.2.1
2	Digital multimeter	4 $\frac{1}{2}$ digit	UDS5	349.1510.02	5.2.8.5 5.2.8.6.1 5.2.8.6.2 5.2.9.2 5.2.9.3
3	Signal generator	20 to 1000 MHz 2050 MHz with ESVD-B2 fitted) level: -130 to 13 dBm frequency error: $< 1 \cdot 10^{-8}$	SMG	801.0001.52	5.2.1 5.2.3 5.2.2.4.1 5.2.2.4.2 5.2.6.1 5.2.6.2 5.2.7 5.2.8.2 5.2.8.3 5.2.8.4 5.2.8.5 5.2.8.6.1 5.2.9.1
4	Signal generator	20 to 3710 MHz level: -130 to 13 dBm	SMHU	835.8011.52	5.2.2.3 5.2.2.4.1
5	3-dB coupler	10 to 1000 (2050) MHz decoupling > 20 dB			5.2.2.4.1
6	Network analyzer	20 to 1000 (2050) MHz	ZWOB2 ZRB	857.0007.02 353.9017.52	5.2.2.1
7	50- Ω termination	20 to 1000 (2050) MHz	RNA	272.4510.50	5.2.4 5.2.5
8	Spectrum analyzer	20 to 2400 MHz sensitivity: -127 dBm	FSB	848.0020.52	5.2.2.2
9	Power meter	20 to 1000 (2050) MHz, Z = 50 Ω -30 to 10 dBm, error < 0.1 dB	NRV	828.2511.02	5.2.6 5.2.7.1 5.2.7.3
10	Pulse generator	Schwarzbeck pulse generator IGU 2912 calibrated to ≤ 0.1 dB			5.2.6.1.2 5.2.6.1.3
11	Attenuator	20 to 1000 (2050) MHz attenuation error ≤ 0.1 dB	RSP	831.3515.02	5.2.6.2 5.2.6.3
12	Oscilloscope	$f_{\max} = 10$ MHz			5.2.7.2
13	RF millivoltmeter		URE2	350.5315.02	5.2.7.4
14	Vector voltmeter		ZPV		5.2.7.5
15	Power supply unit	0 to 35 V, 4 A	NGB 70	177.7227.90	5.2.8.2

5.2 Test Run

The rated specifications of the receiver are tested following at least 30 minutes of warm-up time and after having performed a total calibration. This is the only way to ensure that the guaranteed data are adhered to.

The values given in the following sections cannot be guaranteed; only the specifications stated in the data sheet are binding.

Note: *The digital level values are output via IEC bus with a resolution of 0.01 dB. Reading accuracy for the measured values can thus be increased.*

5.2.1 Frequency Accuracy

Measuring equipment: Frequency counter, 10 MHz, frequency error $< 1 \cdot 10^{-10}$

Test setup: Connect the frequency counter to the 10-MHz reference output.

Test: Measure frequency using frequency counter.
Nominal frequency 10 MHz \pm 1Hz

5.2.2 RF Input

5.2.2.1 Input VSWR

Measuring equipment: Network analyzer

Test setup: Connect the network analyzer via a low-reflection N-cable to the RF input of the ESVD.

Test: Measure the return loss of the ESVD with the following settings:

RF attenuation	Preamplifier	Nominal value of return loss	
		20 to 1000 MHz	1000 to 2050 MHz
0 dB	off	≥ 9.5 dB	≥ 9.5 dB
0 dB	on	≥ 9.5 dB	≥ 9.5 dB
≥ 10 dB	off	≥ 20 dB	≥ 16 dB
≥ 10 dB	on	≥ 20 dB	≥ 16 dB

Measure at no less than 3 frequency points (at the beginning, mid and end of the range) per input filter range (cf. data sheet).

Note: . 9.5 dB return loss corresponds to a VSWR of 2
16 dB return loss corresponds to a VSWR of 1.35
20 dB return loss corresponds to a VSWR of 1.2

5.2.2.2 Interference Voltage of the Oscillator

Measuring equipment: Spectrum analyzer

Test setup: Connect the spectrum analyzer to the RF input of the ESVD.

Receiver settings:
RF ATT 0 dB

Analyzer settings:
Indication in dB μ V
Reference level ... 60 dB μ V
Scale 10 dB/DIV
Bandwidth 1 kHz
Meas. mode Max Hold

Set start and stop frequency of the analyzer depending on receiver frequency according to the following table:

ESVD frequency range	Start frequency	Stop frequency
20 to 1000 MHz	1354.7 MHz	2354.7 MHz
1000 to 1795 MHz	1394.7 MHz	2189.7 MHz
1795 to 2050 MHz	1400.3 MHz	1655.3 MHz

Test: Tune through the receiver frequency in 50-MHz steps such that the level at each frequency is indicated.

Level indicated on the analyzer:

Frequency range	Preamplifier	Oscillator level
20 to 1000 MHz	off	≤ 20 dB μ V
20 to 1000 MHz	on	≤ 10 dB μ V
1000 to 1900 MHz	off	≤ 50 dB μ V
1000 to 1900 MHz	on	≤ 40 dB μ V
1900 to 2050 MHz	off	≤ 60 dB μ V
1900 to 2050 MHz	on	≤ 50 dB μ V

5.2.2.3 Interference Immunity

Measuring equipment: Signal generator

Note: To avoid that the sideband noise of the generator is measured at the receiver frequency, the sideband signal-to-noise ratio of the generator should be higher than 140 Bc/Hz.

Test setup: Connect the signal generator to the RF input of the ESVD.
Level: 100 dB μ V

ESVD settings: RF ATT: 0 dB
MODE: LOW NOISE
DETECTOR: AV
OP RANGE: 60 dB
IF BW: 10 kHz

5.2.2.3.1 Image of the First Intermediate Frequency

Test: ▶ Set the generator frequency depending on the frequency range to the following image frequencies:

Receiver frequency f_{rec}	Image frequency
20 to 1000 MHz	$f_{rec} + 2709.4$ MHz
1000 to 1795 MHz	$f_{rec} + 789.4$ MHz
1795 to 2050 MHz	$f_{rec} - 789.4$ MHz

- ▶ Measure the level P_{ind} at the receiver frequency f_{rec} .
- ▶ Image frequency rejection is obtained as follows: $100 - P_{ind}/dB\mu V$
- ▶ Level indication on the receiver with and without preamplifier according to following table:

Frequency range	Level indication on receiver
20 to 1000 MHz	≤ 10 dB μV
1000 to 1900 MHz	≤ 20 dB μV
1900 to 2050 MHz	≤ 30 dB μV

5.2.2.3.2 Image of the Second Intermediate Frequency

- Test:
- ▶ Set the generator frequency to 249.4 MHz or 1159.4 MHz.
 - ▶ Set the receiver frequency to 100 MHz or 1010 MHz.
 - ▶ Measure the level (P_{ind}).

The image frequency rejection is obtained as follows:

$$100 - P_{ind}/dB\mu V$$

Level indication on the receiver (PREAMP OFF and ON)	$f < 1000$ MHz	< 10 dB μV
	$f > 1000$ MHz	< 20 dB μV

5.2.2.3.3 Image of the Third Intermediate Frequency

- Test:
- ▶ Set the generator frequency to 121.4 MHz.
Set the receiver frequency f_{rec} to 100 MHz.
 - ▶ Measure the level P_{ind} at f_{rec} .
 - ▶ The image frequency rejection is obtained as follows: $100 - P_{ind}/dB\mu V$
- Level indication on the receiver (PREAMP OFF and ON) < 10 dB μV

5.2.2.3.4 IF Interference Immunity

Test: ▶ Set generator frequency and receiver frequency according to following table:

Receiver frequency f_{rec}	Generator frequency
20 to 1000 MHz	1354.7 MHz
1000 to 2050 MHz	394.7 MHz

- ▶ Measure the level P_{ind} at the respective receiving frequencies.
- ▶ IF interference immunity is obtained as follows: $100 - P_{ind} / \text{dB}\mu\text{V}$
- ▶ Level indication on the receiver < 10 dB μV
(PREAMP OFF and ON)

5.2.2.4 Non-Linearities

5.2.2.4.1 Intercept of Third Order

Measuring equipment: Signal generator (2 units)
3-dB coupler

Test setup: Connect the signal generator to the RF input of the ESVD via the 3-dB coupler.
Level applied to the ESVD : 97 dB μV at both f_{g1} and f_{g2}

The intercept point of third order of the test setup must be > 30 dBm to avoid falsification of the measurement (level of the interference products < 17 dB μV).

ESVD settings:
 RF ATT 0 dB (PREAMP OFF)
 10 dB (PREAMP ON)
 MODE LOW NOISE
 DETECTOR AV
 OP Range 60 dB
 IF BW 10 kHz

- Test:
- ▶ Set the generator frequencies f_{g1} and f_{g2} in 5 MHz-steps in the receiving frequency range 20 to 1000 MHz or to 2050 MHz.
 - ▶ Measure the levels of the generators at the respective frequencies (nominal value: 97 dB μV).
 - ▶ Measure the interference products at the frequencies
 $f_{rec1} = 2 \cdot f_{g1} - f_{g2}$ and
 $f_{rec2} = 2 \cdot f_{g2} - f_{g1}$.
 - ▶ The intercept IP3 is calculated according to the following formula:
 with preamplifier

$$\text{IP3/dBm} = (97 \text{ dB}\mu\text{V} - (\text{level at } f_{rec}) / \text{dB}\mu\text{V}) / 2 - 20 \text{ dBm}$$
 without preamplifier

$$\text{IP3/dBm} = (97 \text{ dB}\mu\text{V} - (\text{level at } f_{rec}) / \text{dB}\mu\text{V}) / 2 - 10 \text{ dBm}$$

5.2.3 IF Bandwidths

Measuring equipment: Signal generator

Test setup: Connect the signal generator to the RF input of the ESVD.
 Level: 90 dB μ V
 Frequency: 100 MHz

ESVD settings:
 Frequency: 100 MHz
 RF ATT: AUTO
 MODE: LOW NOISE
 DETECTOR: AV
 OP RANGE: 60 dB

- Test:
- ▶ Turn the frequency of the receiver in 100-Hz steps such that the level indication assumes its maximum value.
 - ▶ Measure the 3-dB-, 6-dB- and 60-dB- bandwidth in accordance with the following table by increasing and decreasing the generator frequency.

nom. bandwidth	3-dB bandwidth	6-dB bandwidth	harmonic factor B_{6dB} / B_{60dB}
10 kHz	5.6 to 8.4 kHz	9.0 to 10.0 kHz	1:4 typ.
120 kHz	72 to 108 kHz	108 to 132 kHz	1:5 typ.
300 kHz	240 to 360 kHz	360 to 440 kHz	1:6 typ.
1 MHz	720 to 880 kHz	900 to 1100 kHz	1:5 typ.

5.2.4 Noise Indication

Measuring equipment: 50- Ω termination

Test setup: Terminate the RF input of the ESVD using 50 Ω .

ESVD settings:
 RF ATT 0 dB
 MODE LOW DISTORTION
 OP RANGE 60 dB
 DETECTOR AV
 IF BW 10 kHz
 MEAS TIME 100 ms

Test: Measure the noise indication in the range from 20 to 1000 or to 2050 MHz:

Nominal values:

Frequency range	Noise indication preamplifier	
	off	on
20 to 1000 MHz	≤ -10 dB μ V typ. -16 dB μ V	≤ -14 dB μ V typ. -20 dB μ V
1000 to 2050 MHz	≤ -10 dB μ V typ. -16 dB μ V	≤ -16 dB μ V typ. -20 dB μ V

5.2.5 Testing the Inherent Spurious Responses

Test setup: Terminate the RF input of the ESVD using 50 Ω .

ESVD settings:

Frequency scan with the following settings:

Start frequency 20 MHz
Stop frequency 1000 (2050) MHz
Step size 100 Hz
RF ATT 0 dB
IF BW 10 kHz
MODE LOW DISTORTION
OP RANGE 30 dB
MEAS TIME 1 ms
Level and frequency axis:
Min level -20 dB
Max level 20 dB
Frequency axis LOG

Test: Start scan; after it has been terminated output results to a plotter.
Max. level 0 dB μ V

5.2.6 Measuring Accuracy

The level measuring accuracy of the ESVD depends on:

- the accuracy of the internal calibration generator,
- the accuracy of the RF attenuator,
- the linearity of the demodulator and the logarithmic amplifier
- the residual calibration error and
- the signal-to-noise ratio.

Provided that the signal-to-noise ratio is sufficient, the maximum total error with average and peak value indication is lower than ± 1 dB (typ. 0.5 dB) in the frequency range up to 1000 MHz and lower than 1.5 dB in the range 1000 to 2050 MHz.

Measuring

equipment:

Signal generator

Power meter

Pulse generator:

Level 80 dB μ V/MHz ± 0.1 dB (at 100 MHz),

Selectable pulse frequency (1 Hz to 1 kHz)

Frequency response $< \pm 0.2$ dB (20 to 1000 MHz)

The output level of the signal generator is calibrated to the nominal value at each frequency set with the help of a thermal power meter (error < 0.1 dB).

5.2.6.1 Frequency Response

5.2.6.1.1 Indicating Mode AV

Test setup: Connect the signal generator to the RF input of the ESVD.
Level 90 dB μ V \pm 0.1 dB

ESVD settings:

RF ATT	50 dB
MODE	LOW NOISE
DETECTOR	AV
OP RANGE	30 dB
IF BW	120 kHz
MEAS TIME	100 ms

Test: Check the level measuring accuracy in the frequency range of 20 to 1000 or to 2050 MHz. Perform a short calibration before every measurement.

Nominal indication (digital)	90 dB μ V
permissible error digital indication:		
frequency range 20 to 1000 MHz	\pm 0.7 dB
frequency range 1000 to 2050 MHz	\pm 1.2 dB

5.2.6.1.2 Indicating Mode Pk and Pk/MHz

a) Accuracy for Sinusoidal Signals

Test setup: Connect the signal generator to the RF input of the ESVD.
Level 90 dB μ V \pm 0.1 dB

ESVD settings:

RF ATT	50 dB
MODE	LOW NOISE
DETECTOR	Pk
OP RANGE	30 dB
IF BW	120 kHz
MEAS TIME	100 ms

Test: Check the level measuring accuracy at 100 MHz. Perform a short calibration before every measurement.

Nominal indication (digital)	90 dB μ V
permissible error digital indication	\pm 0.7 dB

b) Accuracy for Pulse Signals (Pk)

When measuring pulse signals the tolerance of the 6-dB bandwidth of the IF filters is part of the measurement result. The permissible error is thus increased by the bandwidth tolerance.

Test setup: Connect the pulse generator to the RF input of the ESVD.

Pulse frequency: $f_p = 100 \text{ Hz}$

Level: $80 \text{ dB}\mu\text{V}/\text{MHz}$

ESVD settings:

IF bandwidth	10 kHz	120 kHz	300 kHz	1 MHz
RF ATT	0 dB	10 dB	10 dB	20 dB
MODE	LOW NOISE	LOW NOISE	Low Noise	Low Noise
DETECTOR	PK	Pk	Pk	Pk
OP RANGE	30 dB	30 dB	30 dB	30 dB
MEAS TIME	100 ms	100 ms	100 ms	100 ms

Test: Measure the level applied to the ESVD.

IF BW	Nom. level	Permissible error digital indication
10 kHz	40 dB μ V	$\pm 2 \text{ dB}$
120 kHz	62 dB μ V	$\pm 2 \text{ dB}$
300 kHz	72 dB μ V	$\pm 2 \text{ dB}$
1 MHz	80 dB μ V	$\pm 2 \text{ dB}$

c) Accuracy for Pulse Signals (Pk/MHz)

ESVD settings:

DETECTOR Pk/MHz

other settings as under b).

Test: Measure the level applied to the ESVD.

IF BW	Nom. level	Permissible error digital indication
10 kHz	80 dB μ V/MHz	$\pm 1 \text{ dB}$
120 kHz	80 dB μ V/MHz	$\pm 1 \text{ dB}$
300 kHz	80 dB μ V/MHz	$\pm 1 \text{ dB}$
1 MHz	80 dB μ V/MHz	$\pm 1 \text{ dB}$

5.2.6.1.3 Indicating Mode QP

a) Accuracy for Pulses

Test setup: Connect the pulse generator to the RF input of the ESVD.
 Pulse frequency: 100 Hz
 Level: 80 dB μ V/MHz \pm 0.1 dB

ESVD settings:
 RF ATT 10 dB
 MODE LOW NOISE
 DETECTOR QP
 OP RANGE 30 dB
 MEAS TIME 500 ms

Test: Check the measuring accuracy at 100 MHz.
 Nominal level 50 dB μ V \pm 1 dB

b) Accuracy for Sinusoidal Signals

Test setup: Connect the signal generator to the RF input of the ESVD.
 Level: 90 dB μ V \pm 0.1 dB

ESVD settings:
 RF ATT 50 dB
 MODE LOW NOISE
 DETECTOR QP
 OP RANGE 30 dB
 MEAS TIME 500 ms

Test: Check the measuring accuracy at 100 MHz.
 Nominal level 90 dB μ V \pm 1 dB

c) Quasi-peak Weighting Curve

Test setup: Connect the pulse generator to the RF input of the ESVD.
 Level: 80 dB μ V/MHz \pm 0.1 dB

ESVD settings:
 Frequency 100 MHz
 RF ATT 0 dB
 MODE LOW NOISE
 DETECTOR QP
 OP RANGE 30 dB
 MEAS TIME 2 s

Test: Measure level at ESVD depending on pulse frequency of generator in line with the following table. The reference value is the level at 100 Hz pulse frequency.

Pulse frequency	ESVD indication Nom. value	Standard values to VDE0871/Part 1 and CISPR 16	
		Nominal value	Tolerance
100 Hz	50 dB μ V	--	\pm 0.5 dB
1000 Hz	58 dB μ V	+8.0 dB	\pm 1 dB
20 Hz	41 dB μ V	-9.0 dB	\pm 1 dB
10 Hz	36 dB μ V	-14.0 dB	\pm 1.5 dB
2 Hz	24 dB μ V	-26.0 dB	\pm 2.0 dB
1 Hz	21.5 dB μ V	-28.5 dB	\pm 2.0 dB
Single pulse	18.5 dB μ V	-31.5 dB	\pm 2.0 dB

5.2.6.2 Indication Linearity

Measuring equipment: Signal generator
Attenuator, attenuation corrected, max. permissible error < 0.1 dB

Test setup: Connect the signal generator to the RF input of the ESVD via attenuator.

Level of the signal generator 83 dB μ V
Basic attenuation of the attenuator 3 dB

a) 30-dB Range

ESVD settings:

Frequency .. 100 MHz
RF ATT 50 dB
MODE LOW NOISE
DETECTOR .. AV
OP RANGE .. 30 dB
IF BW 10 kHz
MEAS TIME . 100 ms

- Test:
- ▶ Set the level applied to the signal generator such that the ESVD indicates full-scale deflection (80.0 dB μ V).
 - ▶ Increase the attenuation of the attenuator to 33 dB using 2-dB steps and measure the level indication at each setting. At the same time check the level analog indication on the instrument.
The level indication decreases by 2 dB with each attenuation step.

Permissible linearity error:

Digital indication ≤ 0.4 dB
Analog indication ≤ 1.0 dB

b) 60-dB Range

ESVD settings:

Frequency .. 100 MHz
RF ATT 20 dB
MODE LOW NOISE
DETECTOR .. AV
OP RANGE .. 60 dB
IF BW 10 KHz
MEAS TIME . 100 ms

- Test:
- ▶ Set the level applied to the signal generator such that the ESVD indicates full-scale deflection (80.0 dB μ V).
 - ▶ Increase the attenuation of the attenuator from 3 to 63 dB using 5-dB steps and measure the level indication at each setting. At the same time check the level analog indication on the instrument.
The level indication decreases by 5 dB with each attenuation step.

Permissible linearity error:

Digital indication ≤ 0.4 dB
Analog indication ≤ 1.0 dB

5.2.6.3 Accuracy of the Attenuator

Measuring equipment:

Signal generator
Attenuator, attenuation corrected, max. permissible error < 0.1 dB

Test setup:

Connect the signal generator to the RF input of the ESVD via the attenuator.
Level of the signal generator: 123 dB μ V
Attenuation of the attenuator: 80 dB

ESVD settings:

Frequency 100 MHz
RF ATT 40 dB
PREAMP ON
MODE LOW NOISE
DETECTOR AV
OP RANGE 30 dB
IF BW 10 kHz
MEAS TIME 100 ms

Test:

- ▶ Set the level on the signal generator such that the ESVD indicates 43.0 dB μ V.
- ▶ Set the attenuator to 120 dB and RF attenuation of the ESVD to 0 dB.
- ▶ Decrease the attenuation of the attenuator to 0 dB using 10-dB steps.
- ▶ At the same time increase the RF attenuation of the ESVD in 10-dB steps.
- ▶ Measure deviation of level indication at each attenuation setting.
Nominal level 3 dB μ V + RF attenuation
Permissible attenuation error ≤ 0.4 dB

5.2.7 Testing the Outputs

5.2.7.1 AF Output

Measuring equipment: Signal generator
Oscilloscope

Test setup: Connect the signal generator to the RF input of the ESVD.
Frequency: 100 MHz, AM, m = 30 %, AF = 1 kHz
Level: 80 dB μ V

Connect the oscilloscope to the AF output of the ESVD via jack plugs.

ESVD settings:
Frequency 100 MHz
RF ATT 20 dB
MODE LOW NOISE
DETECTOR AV
OP RANGE 60 dB
IF BW 10 kHz
MEAS TIME 100 ms

Test: Set the voltage on the oscilloscope using the volume control such that no visible distortions are currently present.
Settable voltage > 3 V

5.2.7.2 74.7-MHz Output

Measuring equipment: Signal generator
Power meter

Test setup: Connect the signal generator to the RF input of the ESVD.
Frequency: 100 MHz
Level: 90 dB μ V \pm 0.2 dB

Connect the power meter to the 74.7-MHz OUTPUT on the rear panel of the ESVD.

ESVD settings:
Frequency 100 MHz
RF ATT 10 dB
PREAMP OFF

Test:

- ▶ Measure the level using the power meter.
Nominal value -15 dBm
Permissible deviation \pm 4 dB
- ▶ Switch on the preamplifier at the ESVD (PREAMP ON).
- ▶ Measure the level using the power meter.
Nominal value -4 dBm
Permissible deviation \pm 4 dB
- ▶ Measure the 3-dB bandwidth by detuning the signal generator.
Nominal value B₄ dB > 2 MHz

5.2.7.3 10.7-MHz Output

Measuring equipment: Signal generator
RF millivoltmeter (AC)

Test setup: Connect the signal generator to the RF input of the ESVD.
Frequency: 100 MHz
Level: 80 dB μ V \pm 0.2 dB

Connect the RF millivoltmeter to the 10.7 MHz OUTPUT on the rear panel of the ESVD.

ESVD settings:
Frequency 100 MHz
RF ATT 20 dB
OP RANGE 60 dB
DETECTOR AV

Test: ▶ Measure the output level using the RF millivoltmeter.
Nominal value typ. 1000 mV

5.2.7.4 Envelope Output (VIDEO OUTPUT)

Measuring equipment: Signal generator
Digital voltmeter

Test setup: Connect the digital voltmeter to the Video output on the rear panel of the ESVD.
Connect the signal generator to the RF input of the ESVD.
Frequency: 100 MHz
Level: 80 dB μ V \pm 0.2 dB

ESVD settings:
Frequency 100 MHz
RF ATT 20 dB
OP RANGE 60 dB
DETECTOR AV

Test: Measure the output voltage using the digital voltmeter.
Nominal value + 4 V typ.

5.2.7.5 I/Q Outputs (I OUTPUT and Q OUTPUT)

Measuring equipment: Signal generator
RF millivoltmeter
Vector voltmeter

Test setup: Connect signal generator to RF input of the ESVD.
Frequency: 100.02 MHz
Level: -20 dBm \pm 1 dB

ESVD settings:
Frequency 100 MHz
RF ATT 10 dB
MODE LOW DIST
IF BW 300 kHz
PREAMP ON

Test:
▶ Measure the voltage (emf) at in-phase and quadrature output using RF millivoltmeter.
Nominal value 2 V \pm 0.15 V
▶ Determine the voltage between in-phase and quadrature output.
Nominal value \pm 0.2 dB
▶ Measure the phase difference between in-phase and quadrature output using vector voltmeter.
Phase difference between I output (reference phase) and Q output +90° \pm 0.2°

5.2.7.6 Reference Output (10 MHz REF OUTPUT)

Measuring equipment: Power meter

Test setup: Connect power meter to reference output.

Test: Measure level:
Nom. level \geq 7 dBm
Frequency cf. Section 5.2.1

5.2.7.7 User Ports

5.2.7.7.1 Analog Outputs

Measuring equipment: Signal generator
Digital voltmeter

Test setup: Connect the signal generator to the RF input of the ESVD.
Frequency: 100 MHz
Level: 80 dB μ V \pm 0.2 dB.

ESVD settings:
Frequency: 100 MHz
RF ATT: 20 dB
MODE: LOW NOISE
IF BW: 10 kHz
PREAMP: OFF
TRANSDUCER OFF

- Test:
- ▶ Connect the digital voltmeter to the USER PORT between pin 24 (gnd) and pin 23 (recorder 1).
Voltage applied to the DVM 3.75 V
Permissible error \pm 100 mV
 - ▶ Set the level available at the signal generator to 20 dB μ V \pm 0.2 dB.
Voltage applied to the DVM 0.75 V
Permissible error \pm 100 mV
 - ▶ Connect the UDS5 to the USER PORT between pin 24 (gnd) and pin 11 (recorder 2).
Set the level available at the signal generator to 80 dB μ V \pm 0.2 dB.
Voltage applied to the DVM 3.75 V
Permissible error \pm 100 mV
 - ▶ Set the level available at the signal generator to 20 dB μ V \pm 0.2 dB.
Voltage applied to the DVM 0.75 V
Permissible error \pm 100 mV

5.2.7.7.2 Supply Outputs

Measuring equipment: Digital voltmeter

Test setup: Connect the DVM to the user port + 5-V output or + 12-V output.

Test: Measure the voltage present at the + 5-V- or + 12-V output.
Nominal value + 5 V 5.0 V to 5.5 V
Nominal value + 12 V 10.8 to 15 V

5.2.8 Testing the Inputs

5.2.8.1 Checking the External Battery Supply

Measuring equipment: Power supply unit
Digital voltmeter

Test setup: Connect the power supply unit to the EXT-BATT input of the ESVD.
Voltage: 12 V

- Test:
- ▶ Switch on ESVD.
The receiver is activated.
 - ▶ Vary voltage between 11 and 33 V.
The ESVD remains in the activated state.
 - ▶ Reduce voltage at power supply unit.
The ESVD switches off at a voltage of $11\text{ V} \pm 0.2\text{ V}$.

Note: *An instrument reset may occur when increasing the supply voltage to about 15.5 V or when decreasing it to about 14.5 V.*

5.2.8.2 Checking the Antenna Code Socket (X3)

Measuring equipment: Digital voltmeter

Test setup: ESVD settings:
RF ATT 10 dB
MODE LOW DISTORTION
DETECTOR AV
PREAMP OFF

- Test:
- ▶ Connect the DVM between X3/A (gnd) and X3/B (+ 10 V) and measure the voltage.
Nominal value $+10\text{ V} \pm 50\text{ mV}$
 - ▶ Connect the DVM between X3/A (gnd) and X3/K (-10 V) and measure the voltage.
Nominal value $-10\text{ V} \pm 50\text{ mV}$
 - ▶ Connect X3/C to X3/A.
The level unit in the LEVEL display changes from $\text{dB}\mu\text{V}$ to $\text{dB}\mu\text{V/m}$.
 - ▶ Connect X3/D to X3/A.
The level unit in the LEVEL display changes from $\text{dB}\mu\text{V}$ to $\text{dB}\mu\text{A}$.
 - ▶ Connect X3/E to X3/A.
Zero scale deflection on the LEVEL display changes from 0 to 10 dB.
 - ▶ Connect X3/F to X3/A.
Zero scale deflection changes from 0 to 20 dB.
 - ▶ Connect X3/G to X3/A.
Zero scale deflection changes from 0 to 40 dB.
 - ▶ Connect X3/H to X3/A.
Zero scale deflection changes from 0 to 80 dB.
 - ▶ Connect X3/E and X3/M to X3/A.
Zero scale deflection changes from 0 to -10 dB.

5.3 Performance Test Report

Item No.	Characteristic	Test according to section	Min.	Actual	Max.	Unit
1	Frequency accuracy	5.2.1	9.999999	10.000001	MHz
2	Input VSWR RF ATT: 0 dB PREAMP: OFF	5.2.2.1				
	20 MHz		9.5		dB
	35 MHz		9.5		dB
	51 MHz		9.5		dB
	52 MHz		9.5		dB
	90 MHz		9.5		dB
	125 MHz		9.5		dB
	126 MHz		9.5		dB
	200 MHz		9.5		dB
	273 MHz		9.5		dB
	274 MHz		9.5		dB
	380 MHz		9.5		dB
	495 MHz		9.5		dB
	610 MHz		9.5		dB
	717 MHz		9.5		dB
	860 MHz		9.5		dB
	1000 MHz		9.5		dB
	1001 MHz		9.5		dB
	1100 MHz		9.5		dB
	1200 MHz		9.5		dB
	1300 MHz		9.5		dB
	1400 MHz		9.5		dB
	1500 MHz		9.5		dB
	1600 MHz		9.5		dB
	1700 MHz		9.5		dB
	1800 MHz		9.5		dB
	1900 MHz		9.5		dB
	2050 MHz		9.5		dB

Item No.	Characteristic	Test according to section	Min.	Actual	Max.	Unit
3	Input VSWR RF ATT: 0 dB PREAMP: ON	5.2.2.1				
	20 MHz		9.5		dB
	35 MHz		9.5		dB
	51 MHz		9.5		dB
	52 MHz		9.5		dB
	90 MHz		9.5		dB
	125 MHz		9.5		dB
	126 MHz		9.5		dB
	200 MHz		9.5		dB
	273 MHz		9.5		dB
	274 MHz		9.5		dB
	380 MHz		9.5		dB
	495 MHz		9.5		dB
	610 MHz		9.5		dB
	717 MHz		9.5		dB
	860 MHz		9.5		dB
	1000 MHz		9.5		dB
	1001 MHz		9.5		dB
	1100 MHz		9.5		dB
	1200 MHz		9.5		dB
	1300 MHz		9.5		dB
	1400 MHz		9.5		dB
	1500 MHz		9.5		dB
	1600 MHz		9.5		dB
	1700 MHz		9.5		dB
	1800 MHz		9.5		dB
	1900 MHz		9.5		dB
	2050 MHz		9.5		dB

Item No.	Characteristic	Test according to section	Min.	Actual	Max.	Unit
4	Input VSWR	5.2.2.1				
	RF ATT: 10 dB					
	PREAMP: OFF					
	20 MHz		20	-	dB
	35 MHz		20	-	dB
	51 MHz		20	-	dB
	52 MHz		20	-	dB
	90 MHz		20	-	dB
	125 MHz		20	-	dB
	126 MHz		20	-	dB
	200 MHz		20	-	dB
	273 MHz		20	-	dB
	274 MHz		20	-	dB
	380 MHz		20	-	dB
	495 MHz		20	-	dB
	610 MHz		20	-	dB
	717 MHz		20	-	dB
	860 MHz		20	-	dB
	1000 MHz		20	-	dB
	1001 MHz		16	-	dB
	1100 MHz		16	-	dB
	1200 MHz		16	-	dB
	1300 MHz		16	-	dB
	1400 MHz		16	-	dB
	1500 MHz		16	-	dB
	1600 MHz		16	-	dB
	1700 MHz		16	-	dB
	1800 MHz		16	-	dB
	1900 MHz		16	-	dB
	2050 MHz		16	-	dB

Item No.	Characteristic	Test according to section	Min.	Actual	Max.	Unit
5	Input VSWR	5.2.2.1				
	RF ATT: 10 dB					
	PREAMP: ON					
	20 MHz		20	-	dB
	35 MHz		20	-	dB
	51 MHz		20	-	dB
	52 MHz		20	-	dB
	90 MHz		20	-	dB
	125 MHz		20	-	dB
	126 MHz		20	-	dB
	200 MHz		20	-	dB
	273 MHz		20	-	dB
	274 MHz		20	-	dB
	380 MHz		20	-	dB
	495 MHz		20	-	dB
	610 MHz		20	-	dB
	717 MHz		20	-	dB
	860 MHz		20	-	dB
	1000 MHz		20	-	dB
	1001 MHz		16	-	dB
	1100 MHz		16	-	dB
1200 MHz	16	-	dB		
1300 MHz	16	-	dB		
1400 MHz	16	-	dB		
1500 MHz	16	-	dB		
1600 MHz	16	-	dB		
1700 MHz	16	-	dB		
1800 MHz	16	-	dB		
1900 MHz	16	-	dB		
2050 MHz	16	-	dB		
6	RFI voltage of oscillator	5.2.2.2				
	PREAMP: OFF					
	20 to 1000 MHz		-	20	dB μ V
	1000 to 1900 MHz		-	50	dB μ V
	1900 to 2050 MHz		-	60	dB μ V
	PREAMP: ON					
	20 to 1000 MHz		-	10	dB μ V
1000 to 1900 MHz	-	40	dB μ V		
1900 to 2050 MHz	-	50	dB μ V		
7	Interference immunity					
	Image of 1st IF	5.2.2.3.1	-	10	dB μ V
	Image of 2nd IF	5.2.2.3.2				
	20 to 1000 MHz		-	10	dB μ V
	1000 to 2050 MHz	-	20	dB μ V	
Image of 3rd IF	5.2.2.3.3	-	10	dB μ V	
IF interf. immunity	5.2.2.3.4	-	10	dB μ V	

Item No.	Characteristic	Test according to section	Min.	Actual	Max.	Unit
8	Intercept of third order PREAMP: OFF	5.2.2.4.1				
	25/30 MHz		15	-	dBm
	41/46 MHz		15	-	dBm
	57/62 MHz		15	-	dBm
	115/120 MHz		15	-	dBm
	131/136 MHz		15	-	dBm
	263/268 MHz		15	-	dBm
	485/490 MHz		15	-	dBm
	500/505 MHz		15	-	dBm
	707/712 MHz		15	-	dBm
	723/728 MHz		15	-	dBm
	990/995 MHz		15	-	dBm
	1010/1015 MHz		13	-	dBm
	1205/1210 MHz		13	-	dBm
	1405/1410 MHz		13	-	dBm
	1605/1610 MHz		13	-	dBm
	1805/1810 MHz		13	-	dBm
2040/2045 MHz	13	-	dBm		
9	Intercept of third order PREAMP: ON	5.2.2.4.1				
	25/30 MHz		5	-	dBm
	41/46 MHz		5	-	dBm
	57/62 MHz		5	-	dBm
	115/120 MHz		5	-	dBm
	131/136 MHz		5	-	dBm
	263/268 MHz		5	-	dBm
	485/490 MHz		5	-	dBm
	500/505 MHz		5	-	dBm
	707/712 MHz		5	-	dBm
	723/728 MHz		5	-	dBm
	990/995 MHz		5	-	dBm
	1010/1015 MHz		3	-	dBm
	1205/1210 MHz		3	-	dBm
	1405/1410 MHz		3	-	dBm
	1605/1610 MHz		3	-	dBm
	1805/1810 MHz		3	-	dBm
2040/2045 MHz	3	-	dBm		

Item No.	Characteristic	Test accoring to section	Min.	Actual	Max.	Unit
10	Intercept of second order PREAMP: OFF	5.2.2.4.2				
	10 MHz		35	-	dBm
	25 MHz		35	-	dBm
	26 MHz		35	-	dBm
	62 MHz		35	-	dBm
	136 MHz		35	-	dBm
	137 MHz		35	-	dBm
	247 MHz		35	-	dBm
	248 MHz		35	-	dBm
	358 MHz		35	-	dBm
	359 MHz		35	-	dBm
	500 MHz		35	-	dBm
	501 MHz		50	-	dBm
	600 MHz		50	-	dBm
	700 MHz		50	-	dBm
	800 MHz		50	-	dBm
900 MHz	50	-	dBm		
1025 MHz	50	-	dBm		
11	Intercept of second order PREAMP: ON	5.2.2.4.2				
	10 MHz		25	-	dBm
	25 MHz		25	-	dBm
	26 MHz		25	-	dBm
	62 MHz		25	-	dBm
	136 MHz		25	-	dBm
	137 MHz		25	-	dBm
	247 MHz		25	-	dBm
	248 MHz		25	-	dBm
	358 MHz		25	-	dBm
	359 MHz		25	-	dBm
	500 MHz		25	-	dBm
	501 MHz		40	-	dBm
	600 MHz		40	-	dBm
	700 MHz		40	-	dBm
	800 MHz		40	-	dBm
900 MHz	40	-	dBm		
1025 MHz	40	-	dBm		

Item No.	Characteristic	Test according to section	Min.	Actual	Max.	Unit
12	Noise indication PREAMP: OFF	5.2.4				
	20 MHz		-	-10	dB μ V
	51 MHz		-	-10	dB μ V
	52 MHz		-	-10	dB μ V
	125 MHz		-	-10	dB μ V
	126 MHz		-	-10	dB μ V
	273 MHz		-	-10	dB μ V
	274 MHz		-	-10	dB μ V
	495 MHz		-	-10	dB μ V
	496 MHz		-	-10	dB μ V
	717 MHz		-	-10	dB μ V
	718 MHz		-	-10	dB μ V
	1000 MHz		-	-10	dB μ V
	1001 MHz		-	-10	dB μ V
	1100 MHz		-	-10	dB μ V
	1200 MHz		-	-10	dB μ V
	1300 MHz		-	-10	dB μ V
	1400 MHz		-	-10	dB μ V
	1500 MHz		-	-10	dB μ V
	1600 MHz		-	-10	dB μ V
1700 MHz	-	-10	dB μ V		
1800 MHz	-	-10	dB μ V		
1900 MHz	-	-10	dB μ V		
2050 MHz	-	-10	dB μ V		
13	Noise indication PREAMP: ON	5.2.4				
	20 MHz		-	-14	dB μ V
	51 MHz		-	-14	dB μ V
	52 MHz		-	-14	dB μ V
	125 MHz		-	-14	dB μ V
	126 MHz		-	-14	dB μ V
	273 MHz		-	-14	dB μ V
	274 MHz		-	-14	dB μ V
	495 MHz		-	-14	dB μ V
	496 MHz		-	-14	dB μ V
	717 MHz		-	-14	dB μ V
	718 MHz		-	-14	dB μ V
	1000 MHz		-	-14	dB μ V
	1001 MHz		-	-16	dB μ V
	1100 MHz		-	-16	dB μ V
	1200 MHz		-	-16	dB μ V
	1300 MHz		-	-16	dB μ V
	1400 MHz		-	-16	dB μ V
	1500 MHz		-	-16	dB μ V
	1600 MHz		-	-16	dB μ V
1700 MHz	-	-16	dB μ V		
1800 MHz	-	-16	dB μ V		
1900 MHz	-	-16	dB μ V		
2050 MHz	-	-16	dB μ V		

Item No.	Characteristic	Test according to section	Min.	Actual	Max.	Unit
14	Inherent spurious response	5.2.5	-	0	dB μ V
15	Frequency response PREAMP: OFF	5.2.6.1.1				
	20 MHz		89.3	90.7	dB μ V
	100 MHz		89.3	90.7	dB μ V
	200 MHz		89.3	90.7	dB μ V
	300 MHz		89.3	90.7	dB μ V
	400 MHz		89.3	90.7	dB μ V
	500 MHz		89.3	90.7	dB μ V
	600 MHz		89.3	90.7	dB μ V
	700 MHz		89.3	90.7	dB μ V
	800 MHz		89.3	90.7	dB μ V
	900 MHz		89.3	90.7	dB μ V
	1000 MHz		89.3	90.7	dB μ V
	1001 MHz		88.8	91.2	dB μ V
	1100 MHz		88.8	91.2	dB μ V
	1200 MHz		88.8	91.2	dB μ V
	1300 MHz		88.8	91.2	dB μ V
	1400 MHz		88.8	91.2	dB μ V
	1500 MHz		88.8	91.2	dB μ V
	1600 MHz		88.8	91.2	dB μ V
	1700 MHz		88.8	91.2	dB μ V
	1800 MHz		88.8	91.2	dB μ V
	1900 MHz		88.8	91.2	dB μ V
	2050 MHz		88.8	91.2	dB μ V
16	Frequency response PREAMP: ON	5.2.6.1.1				
	20 MHz		89.3	90.7	dB μ V
	100 MHz		89.3	90.7	dB μ V
	200 MHz		89.3	90.7	dB μ V
	300 MHz		89.3	90.7	dB μ V
	400 MHz		89.3	90.7	dB μ V
	500 MHz		89.3	90.7	dB μ V
	600 MHz		89.3	90.7	dB μ V
	700 MHz		89.3	90.7	dB μ V
	800 MHz		89.3	90.7	dB μ V
	900 MHz		89.3	90.7	dB μ V
	1000 MHz		89.3	90.7	dB μ V
	1001 MHz		88.8	91.2	dB μ V
	1100 MHz		88.8	91.2	dB μ V
	1200 MHz		88.8	91.2	dB μ V
	1300 MHz		88.8	91.2	dB μ V
	1400 MHz		88.8	91.2	dB μ V
	1500 MHz		88.8	91.2	dB μ V
	1600 MHz		88.8	91.2	dB μ V
	1700 MHz		88.8	91.2	dB μ V
	1800 MHz		88.8	91.2	dB μ V
	1900 MHz		88.8	91.2	dB μ V
	2050 MHz		88.8	91.2	dB μ V

Item No.	Characteristic	Test according to section	Min.	Actual	Max.	Unit
17	Measuring accuracy DETECTOR: Pk 100 MHz	5.2.6.1a	89.3	90.7	dB μ V
	DETECTOR Pk IF BW 10 kHz	5.2.6.1b	37.0	41.0	dB μ V
	IF BW 120 kHz		60.0	64.0	dB μ V
	IF BW 300 kHz		70.0	74.0	dB μ V
	IF BW 1 MHz		78.0	87.0	dB μ V
	DETECTOR PK/MHz IF BW 10 kHz	5.2.6.1c	79.0	81.0	dB μ V/MHz
	IF BW 120 kHz		79.0	81.0	dB μ V/MHz
	IF BW 300 kHz		79.0	81.0	dB μ V/MHz
	IF BW 1 MHz		79.0	81.0	dB μ V/MHz
	18	Measurement error DETECTOR QP	5.2.6.1.3a	49.0	51
DETECTOR QP		5.2.6.1.3b	89.0	91.0	dB μ V
DETECTOR QP Pulse frequency		5.2.6.1.3c				
100 Hz			50.0	50.0	dB μ V
1000 Hz			57.0	59.0	dB μ V
20 Hz			40.0	42.0	dB μ V
10 Hz			34.5	37.5	dB μ V
2 Hz			22.0	26.0	dB μ V
1 Hz		19.5	23.5	dB μ V	
Single pulse		16.5	20.5	dB μ V	
19	Indication linearity 30-dB range Attenuation of attenuator	5.2.6.2.1				
	3 dB			80.0		dB μ V
	5 dB		77.6	78.4	dB μ V
	7 dB		75.6	76.4	dB μ V
	9 dB		73.6	74.4	dB μ V
	11 dB		71.6	72.4	dB μ V
	13 dB		69.6	70.4	dB μ V
	15 dB		67.6	68.4	dB μ V
	17 dB		65.6	66.4	dB μ V
	19 dB		63.6	64.4	dB μ V
	21 dB		61.6	62.4	dB μ V
	23 dB		59.6	60.4	dB μ V
	25 dB		57.6	58.4	dB μ V
	27 dB		55.6	56.4	dB μ V
	29 dB		53.6	54.4	dB μ V
31 dB		51.6	52.4	dB μ V	
33 dB		49.6	50.4	dB μ V	

Item No.	Characteristic	Test according to section	Min.	Actual	Max.	Unit
20	Indication linearity 60-dB range Attenuation of attenuator	5.2.6.2.2				
	3 dB			80.0		dB μ V
	8 dB		74.6	75.4	dB μ V
	13 dB		69.6	70.4	dB μ V
	18 dB		64.6	65.4	dB μ V
	23 dB		59.6	60.4	dB μ V
	28 dB		54.6	55.4	dB μ V
	33 dB		49.6	50.4	dB μ V
	38 dB		44.6	45.4	dB μ V
	43 dB		39.6	40.4	dB μ V
	48 dB		34.6	35.4	dB μ V
	53 dB		29.6	30.4	dB μ V
58 dB	24.6	25.4	dB μ V		
63 dB	19.6	20.4	dB μ V		
21	Error of attenuator	5.2.6.3				
	0 dB		-	3.0	-	dB μ V
	10 dB		12.6	13.4	dB μ V
	20 dB		22.6	23.4	dB μ V
	30 dB		32.6	33.4	dB μ V
	40 dB		42.6	43.4	dB μ V
	50 dB		52.6	53.4	dB μ V
	60 dB		62.6	63.4	dB μ V
	70 dB		72.6	73.4	dB μ V
	80 dB		82.6	83.4	dB μ V
	90 dB		92.6	93.4	dB μ V
	100 dB		102.6	103.4	dB μ V
	110 dB		112.6	113.4	dB μ V
120 dB	122.6	123.4	dB μ V		
22	AF output	5.2.7.1	1.5	-	V
23	74.7-MHz output	5.2.7.2				
	PREAMP OFF		-18.0	-12.0	dBm
	PREAMP ON		-1.0	-7.0	dBm
	3-dB bandwidth		2.0	-	MHz
24	10.7-MHz output	5.2.7.3	800	1200	mV
25	Video output	5.2.7.4	3.5	4.5	V
26	I/Q outputs	5.2.7.5				
	I output, level		1.85	2.15	V
	Q output, level		1.85	2.15	V
	Level difference I-Q			0.2	dB
	Phase difference		89.8	90.2	Grad
27	Reference output	5.2.7.6	7	-	dBm

Item No.	Characteristic	Test according to section	Min.	Actual	Max.	Unit
28	User port Recorder 1	5.2.7.5.1	3.65	3.85	V
			0.65	0.85	V
	Recorder 2	5.2.7.5.1	3.65	3.85	V
			0.65	0.85	V
	+5-V output	5.2.7.5.2	5.0	5.5	V
	+12-V output	5.2.7.5.2	10.8	15.0	V